

3D View

- NOTES:
- MATERIAL  
1-1: SUS-304 THICKNE=0.10MM
  - SPECIFICATIONS  
2-1: RATED CURRENT: 1.0A  
2-2: VOLTAGE RATING: 1.5V  
2-3: CONTACT RESISTANCE: 80mΩ/MAX  
2-4: WELDING THRUST: ≥3KG  
2-5: OPERATING TEMPERATURE: -40°C~+85°C
  - DURABILITY: 1500 CYCLES
  - SALT SPRAY TIME: 24H
  - ELECTROPLATE: THE NICKEL-PLATED SUBSTRATE IS 50u" MIN
  - REQUIREMENTS  
6-1: TERMINAL TO EAT FULL TIN, NOT PEELING, WELDING OBVIOUS COLOR AND OTHER ADVERSE  
6-2: ROHS, REACH, HF HALOGER ADVERSE OF DOMESTIC AND INTERNATIONAL ENVIRONMENTAL REQUIREMENTS

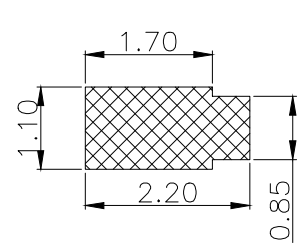

RECOMMENDED PCB LAYOUT  
TOLERANCE: ±0.05MM (FOR REFERENCE ONLY)

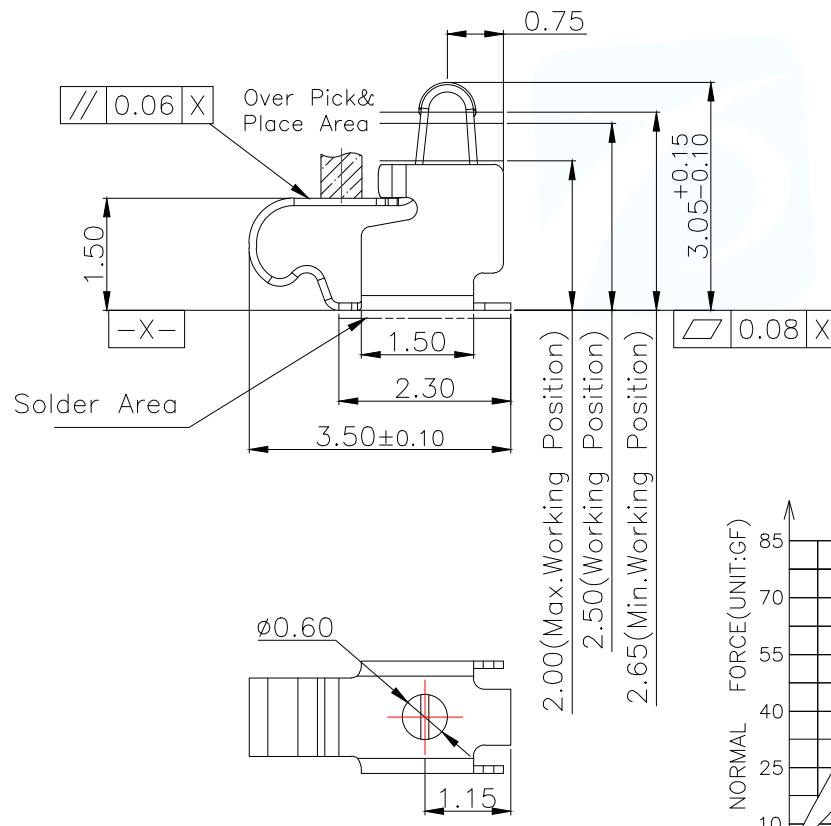
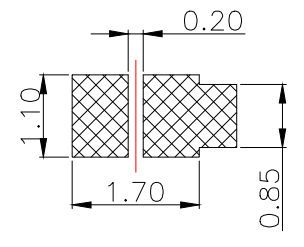

METAL MASK T=0.08  
TOLERANCE: ±0.05MM (FOR REFERENCE ONLY)

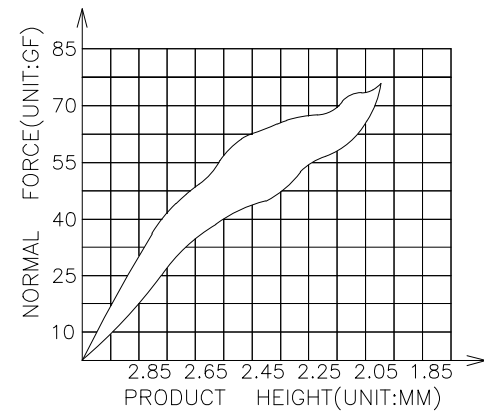

MANUFACTURE DWG		东莞市讯普电子科技有限公司 DongGuan XunPu Electronics Co.,Ltd	
UNLESS OTHERWISE SPECIFIED TOLERANCES		TITLE: 天线弹片 L3.50*W1.50*H3.05	
		PAR	ASP-D3005-A01
DECIMALS:	ANGLES:	DWN	Lucas
X.: ±0.30	X*.: ±2°	CHKD	Ethan
X.X: ±0.20	X.X*.: ±1°	APVD	Jacob
X.XX: ±0.15	X.XX*.: ±0.5°	SCALE: 1:1	UNIT: MM
CUSTOMER COPY		SIZE: A4	SHEET: 1F1
			REV: A

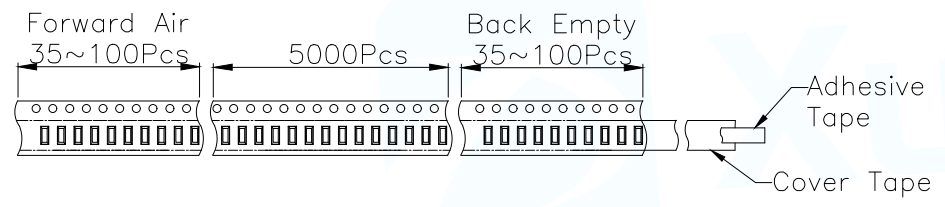
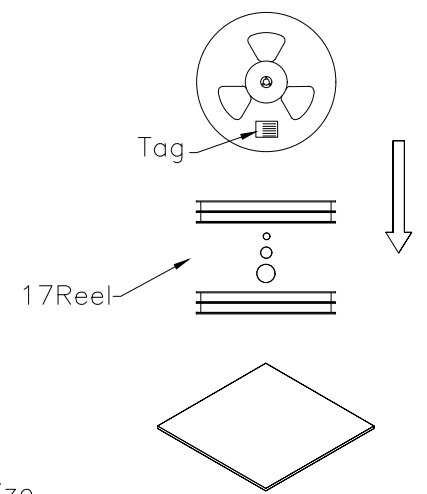
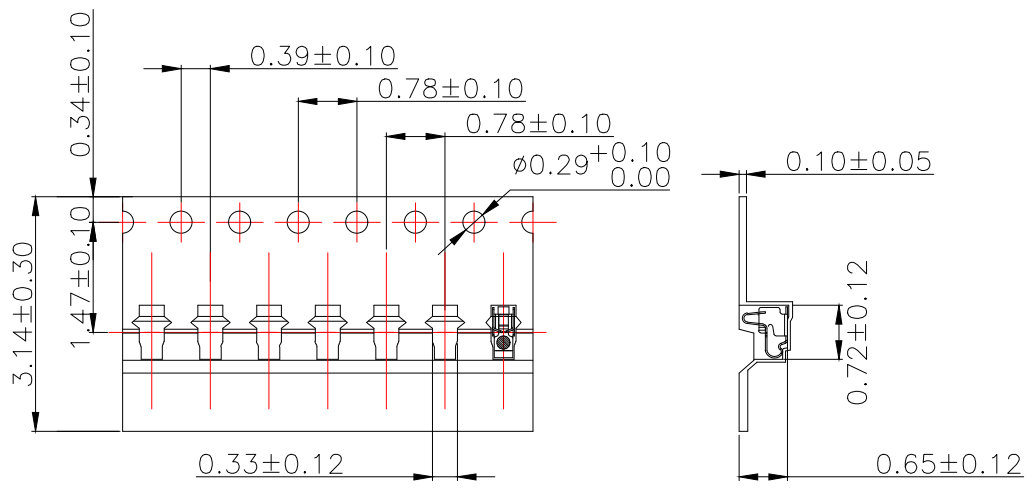

Carton Size  
290\*330\*4 K3K

Customer To Use Direction Pull Out Direction (出料方向)

Carton Size  
345\*345\*360 K=K

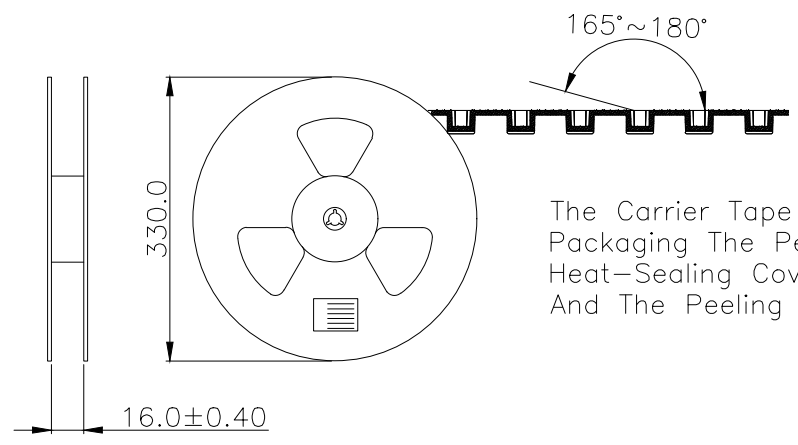
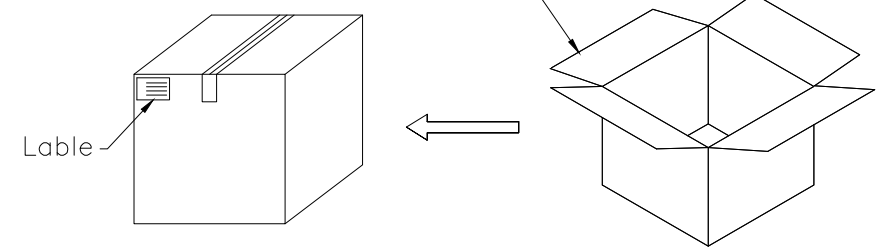

The Carrier Tape Is Heat-Sealed Packaging The Peeling Angle Of The Heat-Sealing Cover Tape Is 165°~180° And The Peeling Force Is 30~120g.

MANUFACTURE DWG		东莞市讯普电子科技有限公司 DongGuan XunPu Electronics Co.,Ltd	
UNLESS OTHERWISE SPECIFIED TOLERANCES		TITLE: 天线弹片 L3.50*W1.50*H3.05	
		PAR	ASP-D3005-A01
DECIMALS:	ANGLES:	DWN	Lucas
X.:±0.30	X.':±2°	CHKD	Ethan
X.X:±0.20	X.X':±1°	APVD	Jacob
X.XX:±0.15	X.XX':±0.5°	SCALE:1:1	UNIT:MM
CUSTOMER COPY		SIZE:A4	SHEET:1F1
			REV:A

## X-ON Electronics

Largest Supplier of Electrical and Electronic Components

*Click to view similar products for [XUNPU](#) manufacturer:*

Other Similar products are found below :

[2.54DC2-01-05PZS](#) [2.54DC2-01-08PZS](#) [2.54DC2-01-10PZS](#) [2.54DC2-01-13PZS](#) [2.54DC2-01-20PZS](#) [ASP-D0801-B01](#) [ASP-D1001-B01](#)  
[ASP-D1101-B01](#) [ASP-D1102-B01](#) [ASP-D1103-A01](#) [ASP-D1104-B01](#) [ASP-D1201-B01](#) [ASP-D1301-B01](#) [ASP-D1401-A01](#) [ASP-D1402-B01](#)  
[ASP-D1403-B01](#) [ASP-D1501-B01](#) [ASP-D1502-A01](#) [ASP-D1503-A01](#) [ASP-D1504-B01](#) [ASP-D1505-B01](#) [ASP-D1506-B31](#) [ASP-D1603-](#)  
[B01](#) [ASP-D1701-B01](#) [ASP-D1801-B01](#) [ASP-D1802-A01](#) [ASP-D1803-A01](#) [ASP-D1805-B01](#) [ASP-D1901-B01](#) [ASP-D2001-A51](#) [ASP-](#)  
[D2002-B01](#) [ASP-D2003-B01](#) [ASP-D2004-B01](#) [ASP-D2005-B01](#) [ASP-D2101-A01](#) [ASP-D2201-B01](#) [ASP-D2301-BE1](#) [ASP-D2402-A01](#)  
[ASP-D2501-A01](#) [ASP-D2501-B01](#) [ASP-D2502-B01](#) [ASP-D2503-B01](#) [ASP-D2504-A31](#) [ASP-D2505-B01](#) [ASP-D2506-A01](#) [ASP-D2516-](#)  
[A01](#) [ASP-D2601-B31](#) [ASP-D2607-A01](#) [ASP-D2611-B51](#) [ASP-D2803-B31](#)