



DC-044-BXXX
W11.50xD9.50xH7.00

插座内芯 (Inner core) : $\Phi 2.0/\Phi 2.5$

插座外孔 (Outer hole) : $\Phi 6.0$

温度范围 (Operating temp) : $-20^{\circ}\text{C TO } +70^{\circ}\text{C}$

额定负荷 (Rated load) : DC 30V 2A

接触电阻 (Contact resistance) : $\leq 0.03\Omega$

绝缘电阻 (Insulation resistance) : $\geq 100\text{M}\Omega$

耐电压 (Withstand voltage) : 500V AC for 1 min

操作寿命 (Operation life) : 5,000 Cycles Min

插拔力 (Operating force) : 3~20N

焊接方式 (Welding mode) : 插件式/DIP

包装方式 (Packaging method) : 散装/Bulk

最小包装 (Minimum packing) : 500/PCS

外形尺寸 (UNIT:MM) / Size Chart

www.xunpudianzi.com

更多资料请参考技术选型档!

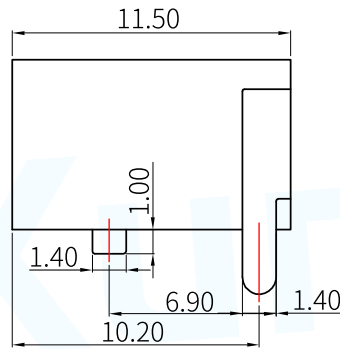
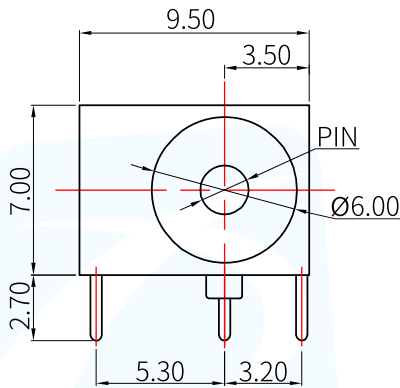

Pin	Part No	Current
$\Phi 2.0$	DC-044-B200	2.0A
$\Phi 2.5$	DC-044-B250	3.0A

线路板安装 (UNIT:MM) / Mounting Dimensions

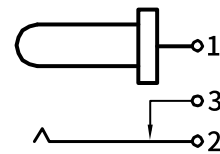
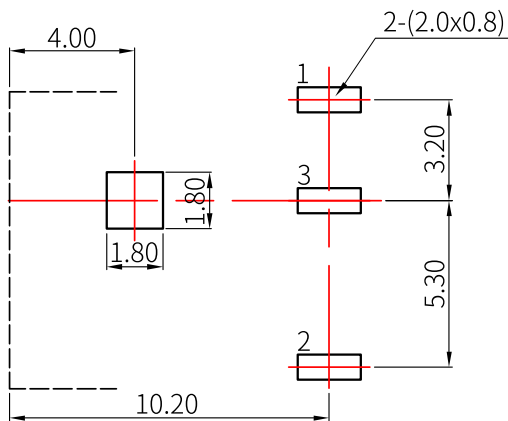

CIRCUIT DIAGRAM

P.C.B LAYOUT(copper-side view)

● 回流焊/Reflow soldering

适用表面贴装型产品/Applicable to surface mount products
温度分布/Temperature distribution

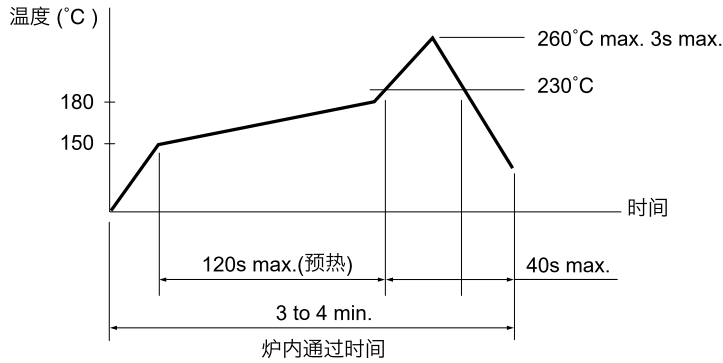

注:

1. 加热方式:以远红外线上下加热方式。
2. 温度测量:用 $\phi 0.1\sim 0.2$ 的 CA(K)或 CC(T)测量位置在焊接连接部(锡/铜箔面)。
3. 固定方式:采用耐热胶带。

● 手焊式/Hand welding

项目/Project	条件/condition
焊接温度 Welding temperature	350°C max.
持续焊接时间 Continuous welding time	3s max.
焊剂斗容量 Flux bucket capacity	60W max.

● 浸焊式/Immersion soldering

项目/Project	条件/condition
助焊剂附着量 Flux adhesion	不附着于零部件贴装面的程度 Not attached to the mounting surface of components
预热温度 Preheating temperature	印刷电路板焊接面的周围温度 100°C max. The temperature around the welding surface of PCB is 100 °C max
预热温度时间 Preheat temperature time	60s max.
焊接温度 welding temperature	260°C max.
焊接浸渍时间 Welding immersion time	5s max.
焊接次数 Welding times	2 times max.

讯普电子 — 连接器、开关制造品牌!

X-ON Electronics

Largest Supplier of Electrical and Electronic Components

Click to view similar products for [xunpu manufacturer](#):

Other Similar products are found below :

[SIM-114](#) [TYC-342-24CB16](#) [SMN-315-ARP7](#) [TF-107](#) [TS-1003S-BR09016](#) [SD-107](#) [MU-0111](#) [TS-1002S-BR06516](#) [TS-1003S-BR07016](#)
[HDMI-001C](#) [MCS-302-KT1](#) [SMN-305-ARP7](#) [USB-256-BRWH150](#) [SMC-217-KT](#) [TF-107-KT1](#) [MCS-303-C1](#) [USB-B12-BRW](#) [MCS-303-](#)
[A1](#) [TYC-340-16CB16](#) [PJ-5410-CB1](#) [PJ-5410-BS1](#) [PJ-5411-BS1](#) [TS-1002S-BR07516](#) [TS-1003-09526](#) [TS-1002S-10526C](#) [TS-1003S-08026](#)
[TS-1003-07026](#) [SMN-327-KT1](#) [SMN-327](#) [UX-155-AR](#) [TS-1002N-09526](#) [TS-1001V-AR04326](#) [MCS-303-B1](#) [TF-101A-P3](#) [TS-1003-](#)
[BR10516](#) [TS-1002S-BR10516](#) [TS-1101-AR006016](#) [TS-1002S-BR06016](#) [TS-1003S-BR08516](#) [TS-1003-06526](#) [TS-1003-BR11016](#) [TS-1003-](#)
[11526](#) [TS-1104-AR006016](#) [TS-1003-12026](#) [TS-1009S-04526](#) [USB-234-ACY](#) [USB-255-BRWH130](#) [USB-211-BCW](#) [TS-1002S-11526C](#) [TS-](#)
[1003S-05526](#)