

Part No	Pin	A	B	C	D	E
FPC-0.3HF-9PWBH10	9	4.90	1.80	2.40	3.03	4.37
FPC-0.3HF-11PWBH10	11	5.50	2.40	3.00	3.63	4.97
FPC-0.3HF-13PWBH10	13	6.10	3.00	3.60	4.23	5.57
FPC-0.3HF-15PWBH10	15	6.70	3.60	4.20	4.83	6.17
FPC-0.3HF-21PWBH10	21	8.50	5.40	6.00	6.63	7.97
FPC-0.3HF-23PWBH10	23	9.10	6.00	6.60	7.23	8.57
FPC-0.3HF-25PWBH10	25	9.70	6.60	7.20	7.83	9.17
FPC-0.3HF-31PWBH10	31	11.50	8.40	9.00	9.63	10.97
FPC-0.3HF-33PWBH10	33	12.10	9.00	9.60	10.23	11.57
FPC-0.3HF-35PWBH10	35	12.70	9.60	10.20	10.83	12.17
FPC-0.3HF-39PWBH10	39	13.90	10.80	11.40	12.03	13.37
FPC-0.3HF-41PWBH10	41	14.50	11.40	12.00	12.63	13.97
FPC-0.3HF-45PWBH10	45	15.70	12.60	13.20	13.83	15.17
FPC-0.3HF-51PWBH10	51	17.50	14.40	15.00	15.63	16.97

Note:

1. Material
 - 1.1: Housing: LCP UL94-V0 Color:Natural.
 - 1.2: Actuator: High Temperature UL94-V0 Color:Black
 - 1.3: Contact: Phosphor Bronze.
 - 1.4: LEG: Phosphor Bronze.
2. Plating
 - 2.1: Contact: See Part Number.
 - 2.2: LEG: Matte Tin Plating Over

Nickel.

3. Rating:
 - 3.1: Operating Voltage: 30V AC/DC.
 - 3.2: Current Rating: 0.2A AC/DC.
 - 3.3: Operating Temperature: -55°C~+85°C.

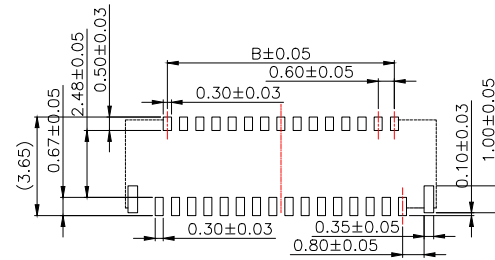
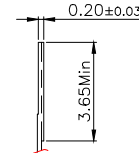
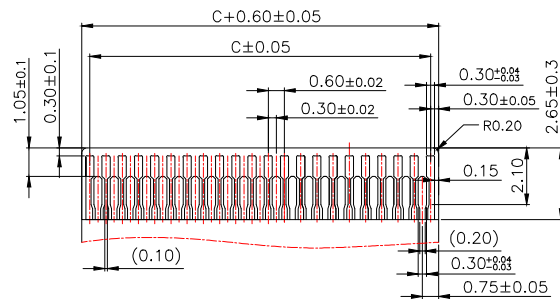

Applicable FPC

FPC/FFC Insert Direction Recommended P.C.B Layout

MANUFACTURE DWG		东莞市讯普电子科技有限公司 DongGuan XunPu Electronics Co.,Ltd	
UNLESS OTHERWISE SPECIFIED TOLERANCES			TITLE:FPC 0.3Pitch 1.0H ZIF R/A Connector 后翻
DECIMALS:	ANGLES:		PAR FPC-0.3HF-NPWBH10
.X:±0.30	.X':±5°		DWN
.XX:±0.20	.XX':±2°		CHKD
.XXX:±0.05	.XXX':±1°	APVD	SCALE:1:1 UNIT:MM
CUSTOMER COPY		SIZE:A4	SHEET:1F1
			REV:A

EMBOSED TAPE PACKING 0.3mm Pitch FPC Connector, ZIF R/A SMT Type

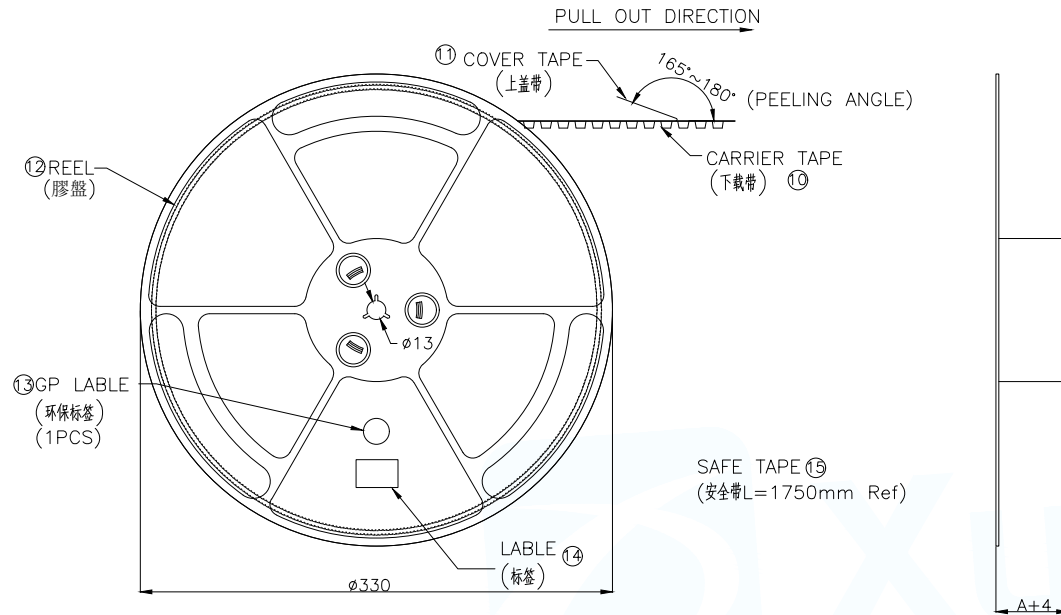

SCALE 1:4

PIN NO.	W	A	B	C	PCS /REEL	REEL/CARTON	SUM(PCS)
9PIN~25 PIN	16	20.5	7.50	-	4000	15	30000
31PIN~45PIN	24	28.5	11.5	-	4000	10	40000
51PIN	32	36.5	14.2	28.4	4000	8	32000

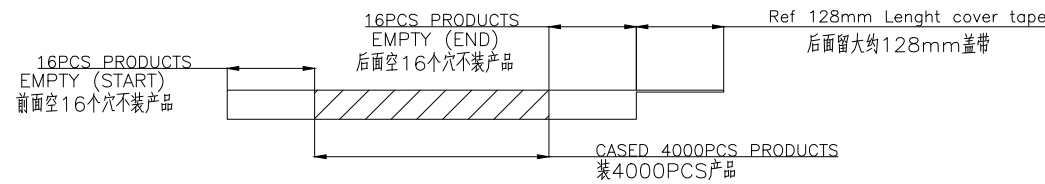
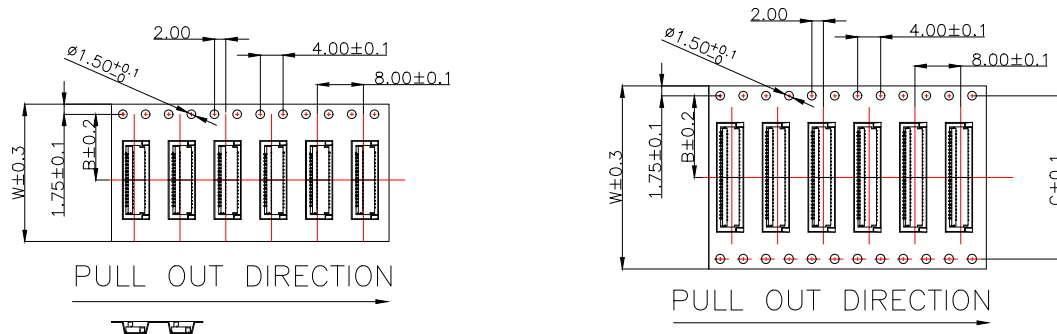
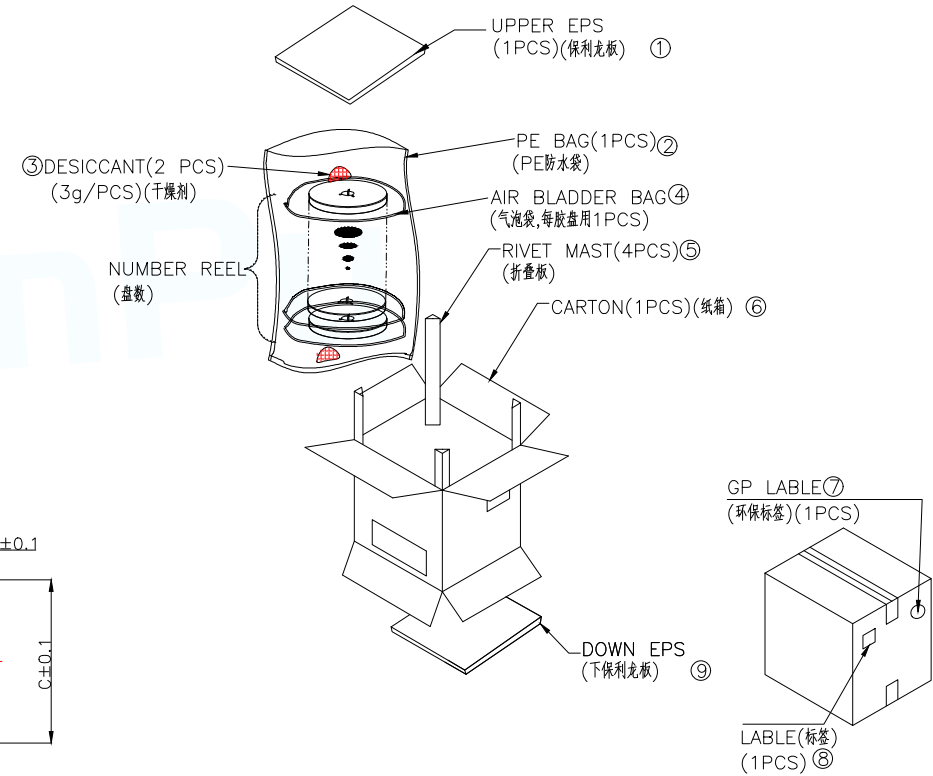

MANUFACTURE DWG		东莞市讯普电子科技有限公司 DongGuan XunPu Electronics Co.,Ltd	
UNLESS OTHERWISE SPECIFIED TOLERANCES			
TITLE:FPC 0.3Pitch 1.0H ZIF R/A Connector 后翻		PAR	FPC-0.3HF-NPWBH10
DECIMALS:	ANGLES:	DWN	
.X:±0.30	.X':±5°	CHKD	
.XX:±0.20	.XX':±2°	APVD	
.XXX:±0.05	.XXX':±1°	SCALE:1:1	UNIT:MM
		SIZE:A4	SHEET:1F1
		CUSTOMER COPY	REV:A

X-ON Electronics

Largest Supplier of Electrical and Electronic Components

Click to view similar products for [FFC & FPC Connectors](#) category:

Click to view products by [XUNPU](#) manufacturer:

Other Similar products are found below :

[00-6200-227-022-800](#) [006205250500825+](#) [006205280500825+](#) [FPH-1602G](#) [086222026001800](#) [52610-0675](#) [62674-201121DLF](#) [52746-1671-TR250](#) [10051922-1610EHLF](#) [10051922-2810EHLF](#) [686322124422](#) [XF3M-2915-1B-R100](#) [AYF353125A](#) [AYF530665TA](#) [AYF534065TA](#) [20FLH-RSM1-TB](#) [207356-1](#) [SFW12R-5STE9LF](#) [SFW18R-1STAE9LF](#) [SFW4R-5STE9LF](#) [52807-0430](#) [046283021002868+](#) [FFC05011-10SBB114W5M](#) [502250-8027](#) [67000-008LF](#) [200528-0260](#) [FH28K-10S-0.5SH](#) [FH52K-6S-0.5SH](#) [0.5K-DX-30PWB](#) [DS1020-08-10VBT12](#) [THD0515-34CL-GF](#) [X05A10L28G](#) [ECC2841061EU](#) [1.0K-DHQX-16PWB](#) [1.0K-DHQX-30PWB](#) [1775333-6](#) [10054365-202110ELF](#) [10054365-242110ELF](#) [10054365-282110ELF](#) [10064555-392220HLF](#) [59453-041110EBHLF](#) [59453-091110EDHLF](#) [62674-241141ALF](#) [62684-432100ALF](#) [62684-451100AHLF](#) [62684-5721N0ALF](#) [HFW11R-1STE1MTLF](#) [HFW12R-1STE9LF](#) [HFW14R-1STE9MTLF](#) [HFW18S-2STE9LF](#)