

| Part No | Pin | A | B | C | D | E |
|--------------------|-----|-------|-------|-------|-------|-------|
| FPC-0.3HF-9PWBH10 | 9 | 4.90 | 1.80 | 2.40 | 3.03 | 4.37 |
| FPC-0.3HF-11PWBH10 | 11 | 5.50 | 2.40 | 3.00 | 3.63 | 4.97 |
| FPC-0.3HF-13PWBH10 | 13 | 6.10 | 3.00 | 3.60 | 4.23 | 5.57 |
| FPC-0.3HF-15PWBH10 | 15 | 6.70 | 3.60 | 4.20 | 4.83 | 6.17 |
| FPC-0.3HF-21PWBH10 | 21 | 8.50 | 5.40 | 6.00 | 6.63 | 7.97 |
| FPC-0.3HF-23PWBH10 | 23 | 9.10 | 6.00 | 6.60 | 7.23 | 8.57 |
| FPC-0.3HF-25PWBH10 | 25 | 9.70 | 6.60 | 7.20 | 7.83 | 9.17 |
| FPC-0.3HF-31PWBH10 | 31 | 11.50 | 8.40 | 9.00 | 9.63 | 10.97 |
| FPC-0.3HF-33PWBH10 | 33 | 12.10 | 9.00 | 9.60 | 10.23 | 11.57 |
| FPC-0.3HF-35PWBH10 | 35 | 12.70 | 9.60 | 10.20 | 10.83 | 12.17 |
| FPC-0.3HF-39PWBH10 | 39 | 13.90 | 10.80 | 11.40 | 12.03 | 13.37 |
| FPC-0.3HF-41PWBH10 | 41 | 14.50 | 11.40 | 12.00 | 12.63 | 13.97 |
| FPC-0.3HF-45PWBH10 | 45 | 15.70 | 12.60 | 13.20 | 13.83 | 15.17 |
| FPC-0.3HF-51PWBH10 | 51 | 17.50 | 14.40 | 15.00 | 15.63 | 16.97 |

Note:

1. Material
 - 1.1: Housing: LCP UL94-V0 Color:Natural.
 - 1.2: Actuator: High Temperature UL94-V0 Color:Black
 - 1.3: Contact: Phosphor Bronze.
 - 1.4: LEG: Phosphor Bronze.
2. Plating
 - 2.1: Contact: See Part Number.
 - 2.2: LEG: Matte Tin Plating Over

Nickel.

3. Rating:
 - 3.1: Operating Voltage: 30V AC/DC.
 - 3.2: Current Rating: 0.2A AC/DC.
 - 3.3: Operating Temperature: -55°C~+85°C.

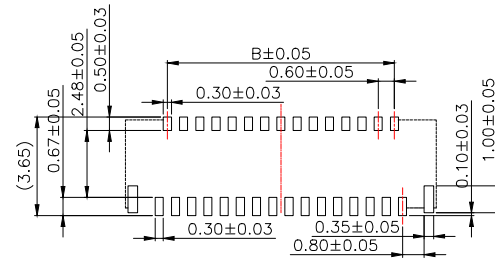
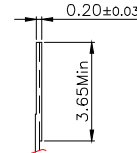
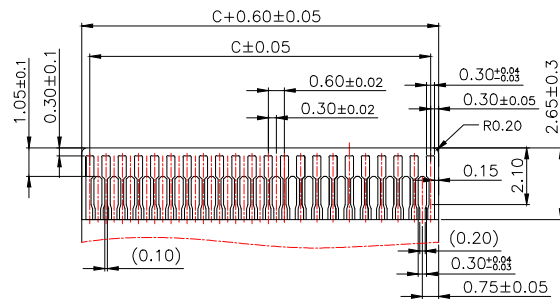

FPC/FFC Insert Direction
Recommended P.C.B Layout

Applicable FPC

| | | | |
|---------------------------------------|-----------|---|--|
| MANUFACTURE DWG | | 东莞市讯普电子科技有限公司 DongGuan XunPu Electronics Co.,Ltd | |
| UNLESS OTHERWISE SPECIFIED TOLERANCES | | | TITLE:FPC 0.3Pitch 1.0H ZIF R/A Connector 后翻 |
| DECIMALS: | ANGLES: | | PAR FPC-0.3HF-NPWBH10 |
| .X:±0.30 | .X':±5° | | DWN |
| .XX:±0.20 | .XX':±2° | | CHKD |
| .XXX:±0.05 | .XXX':±1° | APVD | SCALE:1:1 UNIT:MM |
| CUSTOMER COPY | | SIZE:A4 | SHEET:1F1 |
| | | | REV:A |

EMBOSED TAPE PACKING 0.3mm Pitch FPC Connector, ZIF R/A SMT Type

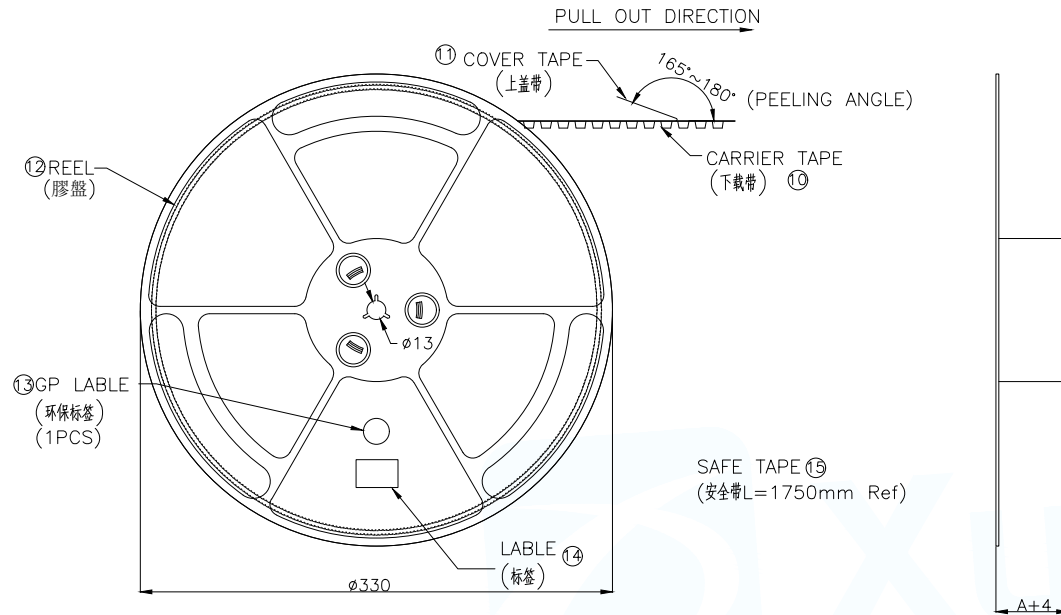

SCALE 1:4

| PIN NO. | W | A | B | C | PCS /REEL | REEL/CARTON | SUM(PCS) |
|-------------|----|------|------|------|-----------|-------------|----------|
| 9PIN~25 PIN | 16 | 20.5 | 7.50 | - | 4000 | 15 | 30000 |
| 31PIN~45PIN | 24 | 28.5 | 11.5 | - | 4000 | 10 | 40000 |
| 51PIN | 32 | 36.5 | 14.2 | 28.4 | 4000 | 8 | 32000 |

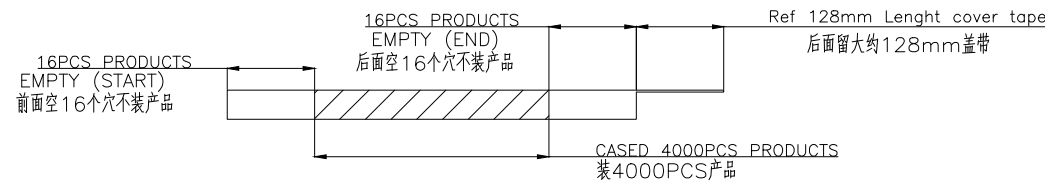
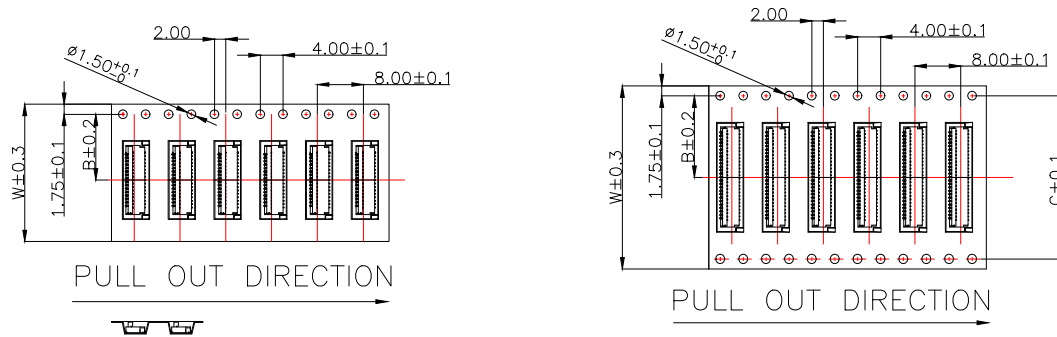
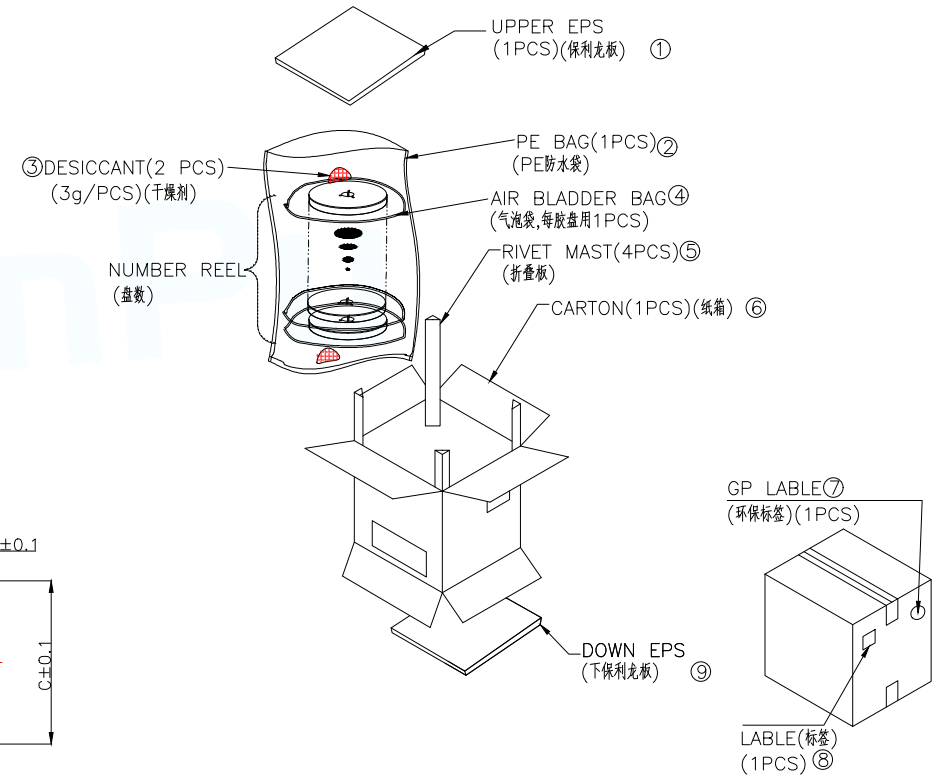

| | | | |
|---|------------|---|-------------------|
| MANUFACTURE DWG | | 东莞市讯普电子科技有限公司 DongGuan XunPu Electronics Co.,Ltd | |
| UNLESS OTHERWISE SPECIFIED TOLERANCES | | | |
| TITLE: FPC 0.3Pitch 1.0H ZIF R/A Connector 后翻 | | PAR | FPC-0.3HF-NPWBH10 |
| DECIMALS: | ANGLES: | DWN | |
| .X: ±0.30 | .X': ±5° | CHKD | |
| .XX: ±0.20 | .XX': ±2° | APVD | |
| .XXX: ±0.05 | .XXX': ±1° | SCALE: 1:1 | UNIT: MM |
| | | SIZE: A4 | SHEET: 1F1 |
| | | | REV: A |

X-ON Electronics

Largest Supplier of Electrical and Electronic Components

Click to view similar products for [FFC & FPC Connectors](#) category:

Click to view products by [XUNPU](#) manufacturer:

Other Similar products are found below :

[00-6200-227-022-800](#) [006205250500825+](#) [006205280500825+](#) [FPH-1602G](#) [086222026001800](#) [52610-0675](#) [62674-201121DLF](#) [52746-1671-TR250](#) [10051922-1610EHLF](#) [10051922-2810EHLF](#) [686322124422](#) [XF3M-2915-1B-R100](#) [AYF353125A](#) [AYF530665TA](#) [AYF534065TA](#) [20FLH-RSM1-TB](#) [207356-1](#) [SFW12R-5STE9LF](#) [SFW18R-1STAE9LF](#) [SFW4R-5STE9LF](#) [52807-0430](#) [046283021002868+](#) [FFC05011-10SBB114W5M](#) [502250-8027](#) [67000-008LF](#) [200528-0260](#) [FH28K-10S-0.5SH](#) [FH52K-6S-0.5SH](#) [0.5K-DX-30PWB](#) [DS1020-08-10VBT12](#) [THD0515-34CL-GF](#) [X05A10L28G](#) [ECC2841061EU](#) [1.0K-DHQX-16PWB](#) [1.0K-DHQX-30PWB](#) [1775333-6](#) [10054365-202110ELF](#) [10054365-242110ELF](#) [10054365-282110ELF](#) [10064555-392220HLF](#) [59453-041110EBHLF](#) [59453-091110EDHLF](#) [62674-241141ALF](#) [62684-432100ALF](#) [62684-451100AHLF](#) [62684-5721N0ALF](#) [HFW11R-1STE1MTLF](#) [HFW12R-1STE9LF](#) [HFW14R-1STE9MTLF](#) [HFW18S-2STE9LF](#)