

4	FPC 0.5mm间距—焊片	PhosphorBronze T=0.20MM	镀锡	2 PCS	
3	FPC 0.5mm间距—锁扣(掌扣)	LCP/PPS	黑色	1 PCS	
2	FPC 0.5mm间距卧贴—PIN	PhosphorBronze T=0.20MM	镀锡/合金	N PCS	
1	FPC 0.5mm间距卧贴—基座	LCP/PA46/PPS	米色	1 PCS	
序号	品名	材料规格	电镀方式/颜色	使用数量	备注

Part No	Pin	A	B	C
FPC-0.5AS-4PWBH20	4	1.50	7.70	2.56
FPC-0.5AS-5PWBH20	5	2.00	8.20	3.06
FPC-0.5AS-6PWBH20	6	2.50	8.70	3.56
FPC-0.5AS-7PWBH20	7	3.00	9.20	4.06
FPC-0.5AS-8PWBH20	8	3.50	9.70	4.56
FPC-0.5AS-9PWBH20	9	4.00	10.20	5.06
FPC-0.5AS-10PWBH20	10	4.50	10.70	5.56
FPC-0.5AS-11PWBH20	11	5.00	11.20	6.06
FPC-0.5AS-12PWBH20	12	5.50	11.70	6.56
FPC-0.5AS-13PWBH20	13	6.00	12.20	7.06
FPC-0.5AS-14PWBH20	14	6.50	12.70	7.56
FPC-0.5AS-15PWBH20	15	7.00	13.20	8.06
FPC-0.5AS-16PWBH20	16	7.50	13.70	8.56
FPC-0.5AS-17PWBH20	17	8.00	14.20	9.06
FPC-0.5AS-18PWBH20	18	8.50	14.70	9.56
FPC-0.5AS-19PWBH20	19	9.00	15.20	10.06
FPC-0.5AS-20PWBH20	20	9.50	15.70	10.56
FPC-0.5AS-21PWBH20	21	10.00	16.20	11.06
FPC-0.5AS-22PWBH20	22	10.50	16.70	11.56
FPC-0.5AS-23PWBH20	23	11.00	17.20	12.06
FPC-0.5AS-24PWBH20	24	11.50	17.70	12.56
FPC-0.5AS-25PWBH20	25	12.00	18.20	13.06
FPC-0.5AS-26PWBH20	26	12.50	18.70	13.56
FPC-0.5AS-27PWBH20	27	13.00	19.20	14.06
FPC-0.5AS-28PWBH20	28	13.50	19.70	14.56
FPC-0.5AS-29PWBH20	29	14.00	20.20	15.06
FPC-0.5AS-30PWBH20	30	14.50	20.70	15.56
FPC-0.5AS-31PWBH20	31	15.00	21.20	16.06
FPC-0.5AS-32PWBH20	32	15.50	21.70	16.56
FPC-0.5AS-33PWBH20	33	16.00	22.20	17.06
FPC-0.5AS-34PWBH20	34	16.50	22.70	17.56
FPC-0.5AS-35PWBH20	35	17.00	23.20	18.06

NOTES:  
 额定电流 Current rating: 0.5A  
 额定电压 Voltage rating: 50V  
 耐电压 Withstand voltage: 500V AC/minute  
 接触电阻 Contact resistance: ≤40mΩ  
 绝缘电阻 Insulation resistance: 100MΩ MIN  
 工作温度 Working temperature: -25℃ ~ +85℃

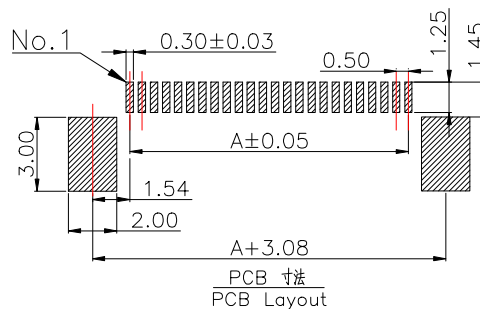
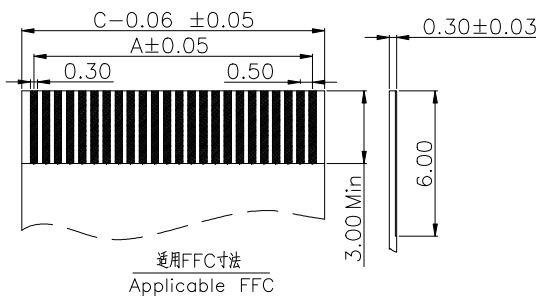
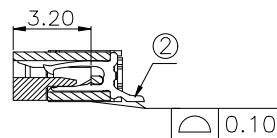
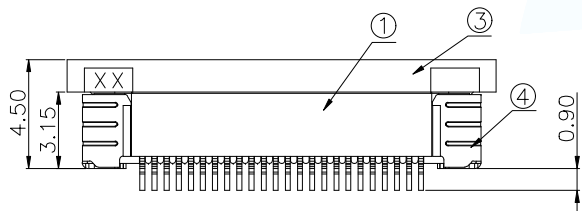
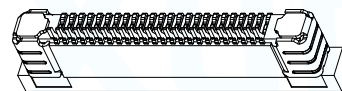
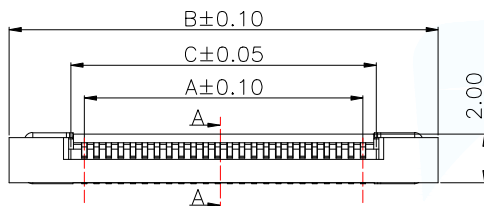
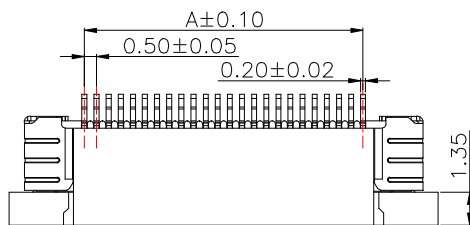

MANUFACTURE DWG			东莞市讯普电子科技有限公司 DongGuan XunPu Electronics Co.,Ltd	
UNLESS OTHERWISE SPECIFIED TOLERANCES			TITLE:FPC 0.5mm间距 卧式贴片上接 Connector(掌扣)	
DECIMALS:	ANGLES:	PAR	FPC-0.5AS-NPWBH20	
.X:±0.38	.X':±5°	DWN		
.XX:±0.20	.XX':±3°	CHKD		
.XXX:±0.05	.XXX':±1°	APVD		
CUSTOMER COPY		SCALE1:1	UNIT:MM	
		SIZE:A4	SHEET:1F1	REV:A

4	FPC 0.5mm间距—焊片	PhosphorBronze T=0.20MM	镀锡	2 PCS	
3	FPC 0.5mm间距—锁扣(窄扣)	LCP/PPS	黑色	1 PCS	
2	FPC 0.5mm间距卧贴—PIN	PhosphorBronze T=0.20MM	镀锡/全金	N PCS	
1	FPC 0.5mm间距卧贴—基座	LCP/PA46/PPS	米色	1 PCS	
序号	品名	材料规格	电镀方式/颜色	使用数量	备注

Part No	Pin	A	B	C
FPC-0.5AS-36PWBH20	36	17.50	23.70	18.56
FPC-0.5AS-37PWBH20	37	18.00	24.20	19.06
FPC-0.5AS-38PWBH20	38	18.50	24.70	19.56
FPC-0.5AS-39PWBH20	39	19.00	25.20	20.06
FPC-0.5AS-40PWBH20	40	19.50	25.70	20.56
FPC-0.5AS-41PWBH20	41	20.00	26.20	21.06
FPC-0.5AS-42PWBH20	42	20.50	26.70	21.56
FPC-0.5AS-43PWBH20	43	21.00	27.20	22.06
FPC-0.5AS-44PWBH20	44	21.50	27.70	22.56
FPC-0.5AS-45PWBH20	45	22.00	28.20	23.06
FPC-0.5AS-46PWBH20	46	22.50	28.70	23.56
FPC-0.5AS-47PWBH20	47	23.00	29.20	24.06
FPC-0.5AS-48PWBH20	48	23.50	29.70	24.56
FPC-0.5AS-49PWBH20	49	24.00	30.20	25.06
FPC-0.5AS-50PWBH20	50	24.50	30.70	25.56
FPC-0.5AS-51PWBH20	51	25.00	31.20	26.06
FPC-0.5AS-52PWBH20	52	25.50	31.70	26.56
FPC-0.5AS-53PWBH20	53	26.00	32.20	27.06
FPC-0.5AS-54PWBH20	54	26.50	32.70	27.56
FPC-0.5AS-55PWBH20	55	27.00	33.20	28.06
FPC-0.5AS-56PWBH20	56	27.50	33.70	28.56
FPC-0.5AS-57PWBH20	57	28.00	34.20	29.06
FPC-0.5AS-58PWBH20	58	28.50	34.70	29.56
FPC-0.5AS-59PWBH20	59	29.00	35.20	30.06
FPC-0.5AS-60PWBH20	60	29.50	35.70	30.56

NOTES:  
 额定电流 Current rating: 0.5A  
 额定电压 Voltage rating: 50V  
 耐电压 Withstand voltage: 500V AC/minute  
 接触电阻 Contact resistance :≤40mΩ  
 绝缘电阻 Insulation resistance: 100MΩ MIN  
 工作温度 Working temperature: -25℃ ~ +85℃

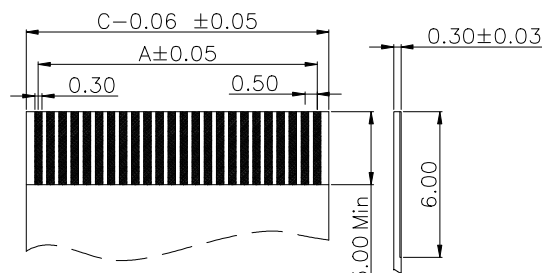
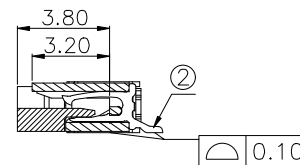
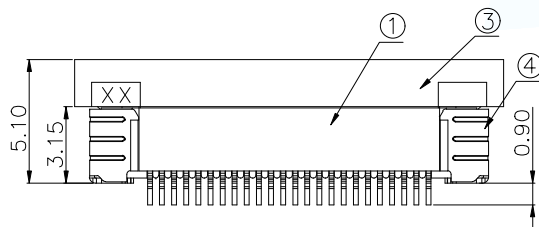
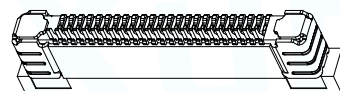
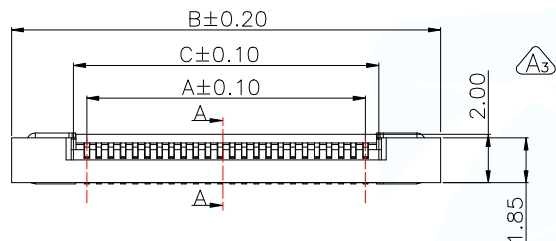
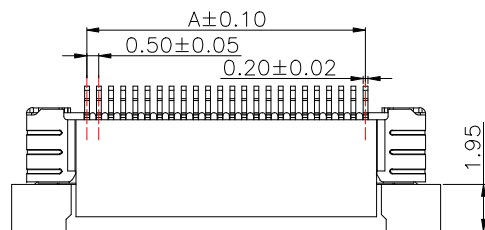

通用FFC寸法  
Applicable FFC

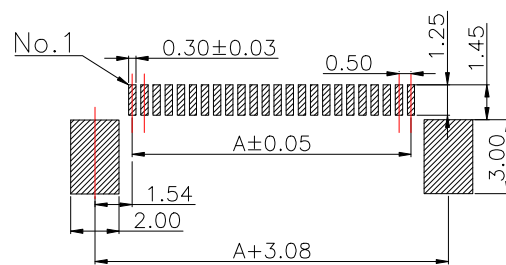

PCB 寸法  
PCB Layout

MANUFACTURE DWG			东莞市讯普电子科技有限公司 DongGuan XunPu Electronics Co.,Ltd	
UNLESS OTHERWISE SPECIFIED TOLERANCES			TITLE:FPC 0.5mm间距 卧式贴片上接 Connector(宽扣)	
DECIMALS:	ANGLES:	PAR	FPC-0.5AS-NPWBH20	
.X:±0.38	.X':±5°	DWN		
.XX:±0.20	.XX':±3°	CHKD		
.XXX:±0.05	.XXX':±1°	APVD		
CUSTOMER COPY		SCALE1:1	UNIT:MM	
		SIZE:A4	SHEET:1F1	REV:A

## X-ON Electronics

Largest Supplier of Electrical and Electronic Components

*Click to view similar products for [FFC & FPC Connectors](#) category:*

*Click to view products by [XUNPU](#) manufacturer:*

Other Similar products are found below :

[00-6200-227-022-800](#) [006205250500825+](#) [006205280500825+](#) [FPH-1602G](#) [086222026001800](#) [52610-0675](#) [62674-201121DLF](#) [52746-1671-TR250](#) [10051922-1610EHLF](#) [10051922-2810EHLF](#) [686322124422](#) [XF3M-2915-1B-R100](#) [AYF353125A](#) [AYF530665TA](#) [AYF534065TA](#) [20FLH-RSM1-TB](#) [207356-1](#) [SFW12R-5STE9LF](#) [SFW18R-1STAE9LF](#) [SFW4R-5STE9LF](#) [52807-0430](#) [046283021002868+](#) [FFC05011-10SBB114W5M](#) [502250-8027](#) [67000-008LF](#) [200528-0260](#) [FH28K-10S-0.5SH](#) [FH52K-6S-0.5SH](#) [0.5K-DX-30PWB](#) [DS1020-08-10VBT12](#) [THD0515-34CL-GF](#) [X05A10L28G](#) [ECC2841061EU](#) [1.0K-DHQX-16PWB](#) [1.0K-DHQX-30PWB](#) [1775333-6](#) [10054365-202110ELF](#) [10054365-242110ELF](#) [10054365-282110ELF](#) [10064555-392220HLF](#) [59453-041110EBHLF](#) [59453-091110EDHLF](#) [62674-241141ALF](#) [62684-432100ALF](#) [62684-451100AHLF](#) [62684-5721N0ALF](#) [HFW11R-1STE1MTLF](#) [HFW12R-1STE9LF](#) [HFW14R-1STE9MTLF](#) [HFW18S-2STE9LF](#)