

4	0.50mm间距前插后翻—右焊片/左焊片	磷青铜 C5191 T=0.15mm	镀锡	各1PCS	A01—右焊片 A02—左焊片
3	0.50mm间距前插后翻—PIN	磷青铜 C5210R T=0.15mm	镀锡/金	N PCS	
2	0.50mm间距前插后翻——锁扣	LCP	黑色	1 PCS	
1	0.50mm间距前插后翻——基座	LCP	米色	1 PCS	
序号	品名	材料规格	电镀/颜色	数量	备注

Part No	Pin	A	B	C
FPC-0.5HF-4PWBH20	4	1.50	2.56	5.50
FPC-0.5HF-5PWBH20	5	2.00	3.06	6.00
FPC-0.5HF-6PWBH20	6	2.50	3.56	6.50
FPC-0.5HF-7PWBH20	7	3.00	4.06	7.00
FPC-0.5HF-8PWBH20	8	3.50	4.56	7.50
FPC-0.5HF-9PWBH20	9	4.00	5.06	8.00
FPC-0.5HF-10PWBH20	10	4.50	5.56	8.50
FPC-0.5HF-11PWBH20	11	5.00	6.06	9.00
FPC-0.5HF-12PWBH20	12	5.50	6.56	9.50
FPC-0.5HF-13PWBH20	13	6.00	7.06	10.00
FPC-0.5HF-14PWBH20	14	6.50	7.56	10.50
FPC-0.5HF-15PWBH20	15	7.00	8.06	11.00
FPC-0.5HF-16PWBH20	16	7.50	8.56	11.50
FPC-0.5HF-17PWBH20	17	8.00	9.06	12.00
FPC-0.5HF-18PWBH20	18	8.50	9.56	12.50
FPC-0.5HF-19PWBH20	19	9.00	10.06	13.00
FPC-0.5HF-20PWBH20	20	9.50	10.56	13.50
FPC-0.5HF-21PWBH20	21	10.00	11.06	14.00
FPC-0.5HF-22PWBH20	22	10.50	11.56	14.50
FPC-0.5HF-23PWBH20	23	11.00	12.06	15.00
FPC-0.5HF-24PWBH20	24	11.50	12.56	15.50
FPC-0.5HF-25PWBH20	25	12.00	13.06	16.00
FPC-0.5HF-26PWBH20	26	12.50	13.56	16.50
FPC-0.5HF-27PWBH20	27	13.00	14.06	17.00
FPC-0.5HF-28PWBH20	28	13.50	14.56	17.50
FPC-0.5HF-29PWBH20	29	14.00	15.06	18.00
FPC-0.5HF-30PWBH20	30	14.50	15.56	18.50
FPC-0.5HF-31PWBH20	31	15.00	16.06	19.00
FPC-0.5HF-32PWBH20	32	15.50	16.56	19.50
FPC-0.5HF-33PWBH20	33	16.00	17.06	20.00
FPC-0.5HF-34PWBH20	34	16.50	17.56	20.50
FPC-0.5HF-35PWBH20	35	17.00	18.06	21.00
FPC-0.5HF-36PWBH20	36	17.50	18.56	21.50
FPC-0.5HF-37PWBH20	37	18.00	19.06	22.00
FPC-0.5HF-38PWBH20	38	18.50	19.56	22.50
FPC-0.5HF-39PWBH20	39	19.00	20.06	23.00

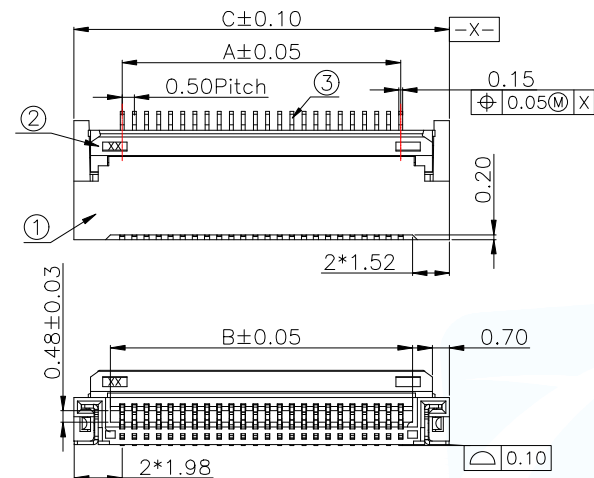

NOTES:

- 额定电流 Current rating: 0.5A
- 额定电压 Voltage rating: 50V
- 耐压 Withstand voltage: 500V AC/minute
- 接触电阻 Contact resistance :≤40mΩ
- 绝缘电阻 Insulation resistance: 100MΩ MIN
- 工作温度 Working temperature: -25℃ ~ +85℃

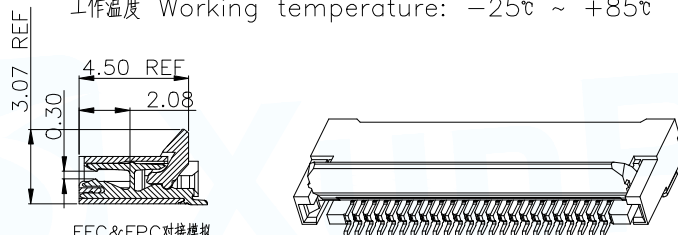

FFC&FPC对接模拟
注:PCB上板高温前锁扣必须处于打开状态

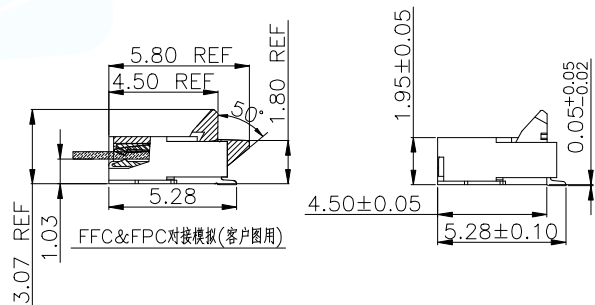
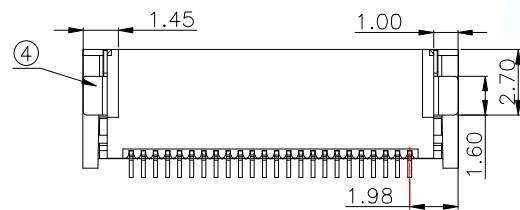

FFC&FPC对接模拟(客户图用)

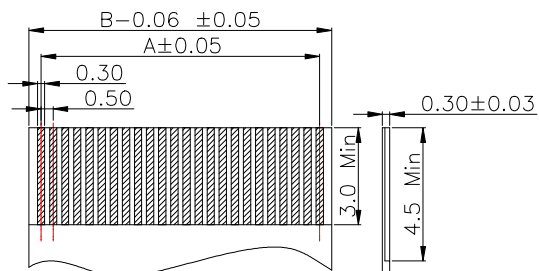

适用FFC寸法
Applicable FFC

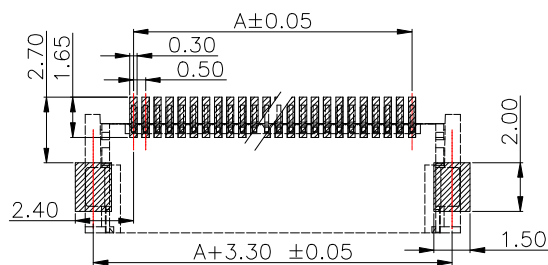

PCB 寸法
PCB Layout

MANUFACTURE DWG			东莞市讯普电子科技有限公司 DongGuan XunPu Electronics Co.,Ltd	
UNLESS OTHERWISE SPECIFIED TOLERANCES			TITLE:FPC 0.50mm间距前插后翻式双接 (K=0.30mm)	
DECIMALS:	ANGLES:	PAR	FPC-0.5HF-NPWBH20	
.X:±0.38	.X':±5°	DWN		
.XX:±0.20	.XX':±3°	CHKD		
.XXX:±0.05	.XXX':±1°	APVD		
CUSTOMER COPY		SCALE1:1	UNIT:MM	
		SIZE:A4	SHEET:1F1	REV:A

4	0.50mm间距前插后翻—右焊片/左焊片	磷青铜 C5191 T=0.15mm	镀锡	各1PCS	A01—右焊片 A02—左焊片
3	0.50mm间距前插后翻—PIN	磷青铜 C5210R T=0.15mm	镀锡/金	N PCS	
2	0.50mm间距前插后翻——锁扣	LCP	黑色	1 PCS	
1	0.50mm间距前插后翻——基座	LCP	米色	1 PCS	
序号	品名	材料规格	电镀/颜色	数量	备注

Part No	Pin	A	B	C
FPC-0.5HF-40PWBH20	40	19.50	20.56	23.50
FPC-0.5HF-41PWBH20	41	20.00	21.06	24.00
FPC-0.5HF-42PWBH20	42	20.50	21.56	24.50
FPC-0.5HF-43PWBH20	43	21.00	22.06	25.00
FPC-0.5HF-44PWBH20	44	21.50	22.56	25.50
FPC-0.5HF-45PWBH20	45	22.00	23.06	26.00
FPC-0.5HF-46PWBH20	46	22.50	23.56	26.50
FPC-0.5HF-47PWBH20	47	23.00	24.06	27.00
FPC-0.5HF-48PWBH20	48	23.50	24.56	27.50
FPC-0.5HF-49PWBH20	49	24.00	25.06	28.00
FPC-0.5HF-50PWBH20	50	24.50	25.56	28.50
FPC-0.5HF-51PWBH20	51	25.00	26.06	29.00
FPC-0.5HF-52PWBH20	52	25.50	26.56	29.50
FPC-0.5HF-53PWBH20	53	26.00	27.06	30.00
FPC-0.5HF-54PWBH20	54	26.50	27.56	30.50
FPC-0.5HF-55PWBH20	55	27.00	28.06	31.00
FPC-0.5HF-56PWBH20	56	27.50	28.56	31.50
FPC-0.5HF-57PWBH20	57	28.00	29.06	32.00
FPC-0.5HF-58PWBH20	58	28.50	29.56	32.50
FPC-0.5HF-59PWBH20	59	29.00	30.06	33.00
FPC-0.5HF-60PWBH20	60	29.50	30.56	33.50

NOTES:

额定电流 Current rating: 0.5A

额定电压 Voltage rating: 50V

耐电压 Withstand voltage: 500V AC/minute

接触电阻 Contact resistance :≤40mΩ

绝缘电阻 Insulation resistance: 100MΩ MIN

工作温度 Working temperature: -25℃ ~ +85℃

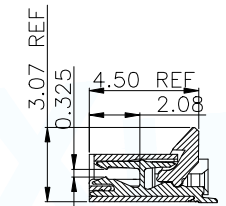
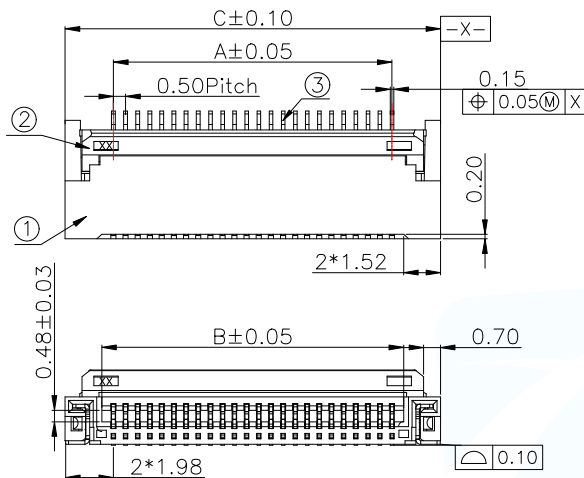

FFC&FPC对接模拟

注:产品未插排线,未焊接前,锁扣必须处于打开状态

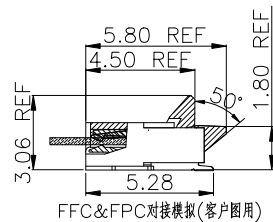
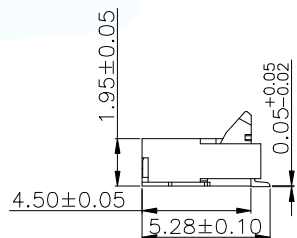
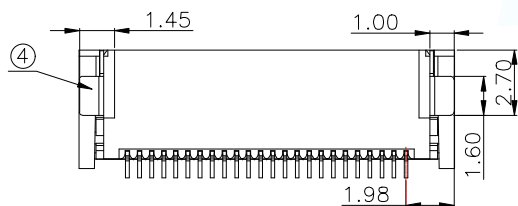

FFC&FPC对接模拟(客户图用)

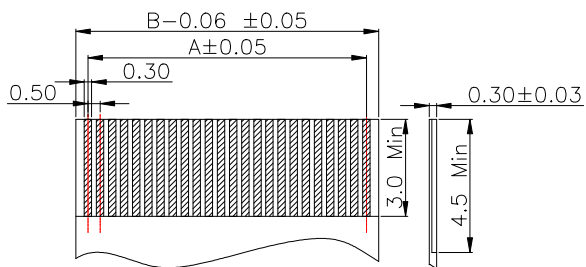
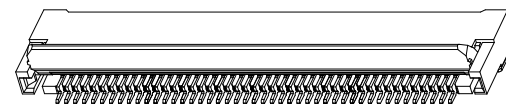

适用FFC寸法
Applicable FFC

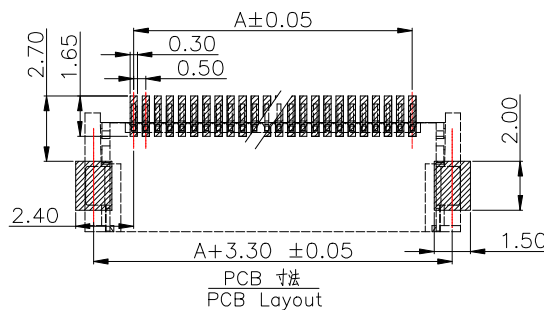

PCB 寸法
PCB Layout

MANUFACTURE DWG		 东莞市讯普电子科技有限公司 DongGuan XunPu Electronics Co.,Ltd	
UNLESS OTHERWISE SPECIFIED TOLERANCES			TITLE:FPC 0.50mm间距前插后翻式双接 (K=0.325mm)
DECIMALS:	ANGLES:		PAR FPC-0.5HF-NPWBH20
.X:±0.38	.X':±5°		DWN
.XX:±0.20	.XX':±3°		CHKD
.XXX:±0.05	.XXX':±1°	APVD	SCALE1:1 UNIT:MM
CUSTOMER COPY		SIZE:A4	SHEET:1F1 REV:A

X-ON Electronics

Largest Supplier of Electrical and Electronic Components

Click to view similar products for [FFC & FPC Connectors](#) category:

Click to view products by [XUNPU](#) manufacturer:

Other Similar products are found below :

[00-6200-227-022-800](#) [006205250500825+](#) [006205280500825+](#) [FPH-1602G](#) [086222026001800](#) [52610-0675](#) [62674-201121DLF](#) [52746-1671-TR250](#) [10051922-1610EHLF](#) [10051922-2810EHLF](#) [686322124422](#) [XF3M-2915-1B-R100](#) [AYF353125A](#) [AYF530665TA](#) [AYF534065TA](#) [20FLH-RSM1-TB](#) [207356-1](#) [SFW12R-5STE9LF](#) [SFW18R-1STAE9LF](#) [SFW4R-5STE9LF](#) [52807-0430](#) [046283021002868+](#) [FFC05011-10SBB114W5M](#) [502250-8027](#) [67000-008LF](#) [200528-0260](#) [FH28K-10S-0.5SH](#) [FH52K-6S-0.5SH](#) [0.5K-DX-30PWB](#) [DS1020-08-10VBT12](#) [THD0515-34CL-GF](#) [X05A10L28G](#) [ECC2841061EU](#) [1.0K-DHQX-16PWB](#) [1.0K-DHQX-30PWB](#) [1775333-6](#) [10054365-202110ELF](#) [10054365-242110ELF](#) [10054365-282110ELF](#) [10064555-392220HLF](#) [59453-041110EBHLF](#) [59453-091110EDHLF](#) [62674-241141ALF](#) [62684-432100ALF](#) [62684-451100AHLF](#) [62684-5721N0ALF](#) [HFW11R-1STE1MTLF](#) [HFW12R-1STE9LF](#) [HFW14R-1STE9MTLF](#) [HFW18S-2STE9LF](#)