

RECOMMENDED PCB LAYOUT
(TOLERANCE: ±0.05)

 CENTER CONTACT
 GROUND CONTACT

NOTES

- 1.0. RATING (额定值) :
- 1.1. VOITAGE (电压) : 60 VAC (R.M.S.)
 - 1.2. NOMINAL CHARACTERISTIC IMPEDANCE (特性阻抗) : 50 Ohm
 - 1.3. APPLICABLE FREQUENCY (适用频率) : DC ~ 6GHz
 - 1.4. VSWR (电压驻波比) : 1.3 MAX. (DC~3GHz), 1.5 MAX. (3~6GHz)
 - 1.5. TEMPERATURE (适用温度) : -40°C TO +85°C
 - 1.6. APPLIED TO IR SOLDERING PROCESS (适用回流焊方式)
- 2.0. MATERIAL SEE BILL OF MATERIAL (材料清单):
- 2.1. HOUSING (塑壳) : THERMOPLASTIC LCP, UL94V-0 (LCP符合UL94V-0),
 - 2.2. CENTER CONTACT: COPPER ALLOY C5191
 - 2.3. SHELL CONTACT (外壳) : COPPER ALLOY C5191 (铜合金C5191).

MANUFACTURE DWG		 东莞市讯普电子科技有限公司 DongGuan XunPu Electronics Co.,Ltd	
UNLESS OTHERWISE SPECIFIED TOLERANCES			TITLE: MICRO RF I BAORD SMT 3 PADS TYPE
DECIMALS:	ANGLES:		PAR IPEX-001
X.X±0.15	.°±2.0°		DWN
X.XX±0.05	X.°±2.0°		CHKD
X.XXX±0.05	X.X°±1.0°	APVD	SCALE:1:1 UNIT:MM
CUSTOMER COPY		SIZE:A4	SHEET:1F1 REV:A

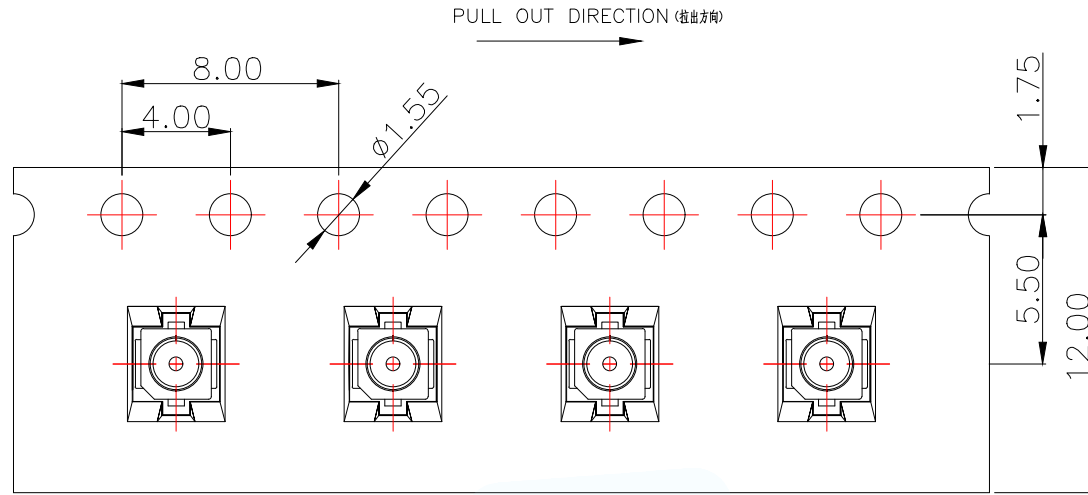

NOTES(备注):

- MATERIAL(材料):
 - EMBOSSD CARRIER(载体): PET
 - COVER TAPE(盖带): PET
 - REEL(卷盘): PS
 - SHIPPING CARTON(包装箱): CORRUGATED FIBER(多层瓦楞纸)
- DIMENSION(尺寸):
 - REEL(卷盘): W=12.5
 - SHIPPING CARTON(包装箱): L=350, W=350, H=190
- QUANTITY(数量):
 - PRIMARY PACKING(基本包装): 5000PCS/REEL
 - CRITERION PACKING(标准包装): 10REELS/CARTON(10卷/箱50000PCS)
- WEIGHT(重量):
 - NET WEIGHT(净重): 0.50KG/REEL.
 - GROSS WEIGHT(总重): 0.50KG/REEL, 5.5KG/CARTON.
- PEELING RESISTANCE(盖带剥离力): 10gf~130gf.

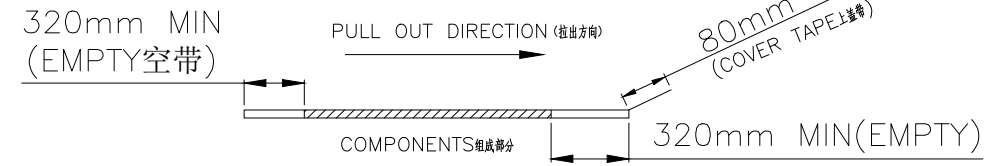
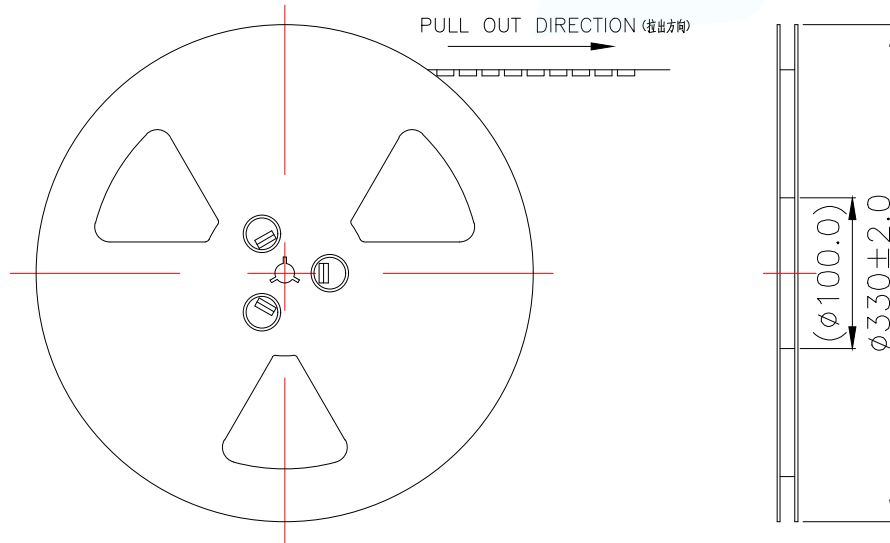

MANUFACTURE DWG		东莞市讯普电子科技有限公司 DongGuan XunPu Electronics Co.,Ltd	
UNLESS OTHERWISE SPECIFIED TOLERANCES		TITLE: MICRO RF I BAORD SMT 3 PADS TYPE	PAR IPEX-001
DECIMALS:	ANGLES:		DWN
X.X±0.15	.°±2.0°		CHKD
X.XX±0.05	X.°±2.0°		APVD
X.XXX±0.05	X.X°±1.0°	CUSTOMER COPY	SCALE:1:1 UNIT:MM SIZE:A4 SHEET:1F1 REV:A

△ ID LABEL

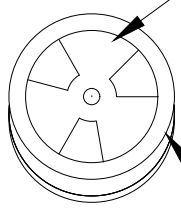

5,000PCS/REEL

10REELS/CARTON

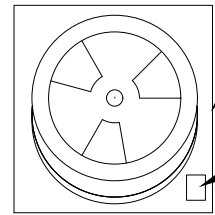
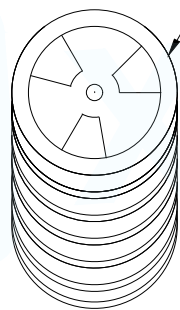

PE BAG

DRY BAG

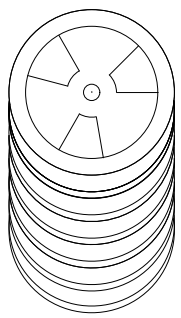



品名 NAME: _____
 料号 PART No.: _____
 客户料号 CLIENT P/N: _____
 客户订单 CLIENT PO#: _____
 数量 Q'TY: _____ 重量 WEIGHT: _____
 批次 LOT No.: _____
 日期 DATE: _____

ID LABEL

STICK TAPE

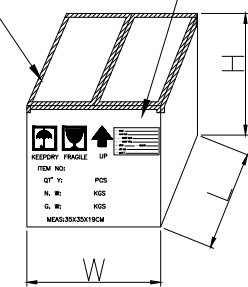
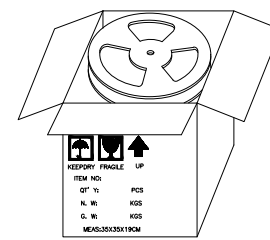
ID LABEL



MANUFACTURE DWG		 东莞市讯普电子科技有限公司 DongGuan XunPu Electronics Co.,Ltd	
UNLESS OTHERWISE SPECIFIED TOLERANCES			TITLE: MICRO RF I BAORD SMT 3 PADS TYPE
DECIMALS:	ANGLES:		PAR IPEX-001
X.X±0.15	.°±2.0°		DWN
X.XX±0.05	X.°±2.0°		CHKD
X.XXX±0.05	X.X°±1.0°	APVD	SCALE 1:1 UNIT:MM
CUSTOMER COPY		SIZE:A4	SHEET:1F1 REV:A

X-ON Electronics

Largest Supplier of Electrical and Electronic Components

Click to view similar products for [RF Connectors](#) / [Coaxial Connectors](#) category:

Click to view products by [XUNPU](#) manufacturer:

Other Similar products are found below :

[8915-1511-000](#) [89674-0827](#) [6002-7051-003](#) [6059674-1](#) [630059-000](#) [M39030/3-01N](#) [6501-1071-002](#) [6769](#) [7002-1572-002](#) [7003-1542-011](#)
[7003-1572-002](#) [7004-1512-000](#) [7009-1511-004](#) [7101-1541-010](#) [7105-1521-002](#) [7145-1521-002](#) [7203-1571-003](#) [7209-1511-011](#) [7210-1511-](#)
[040](#) [7242-1511-000](#) [73216-2241](#) [73404-2300](#) [7405-1521-005](#) [7405-1521-802](#) [8527](#) [8547](#) [FS11V](#) [877931](#) [8808-1511-001](#) [9074-9513-000](#)
[PL11C-026](#) [PL40-36](#) [PL71-9](#) [PL74C-221](#) [9408-1113-000](#) [980-8666-005](#) [1200690078](#) [1-201144-1](#) [120919](#) [R107003010W](#) [R112186000](#)
[R113053000W](#) [R113082097](#) [R113236000](#) [R113240000](#) [R113240097](#) [R114083000](#) [R114670000W](#) [R123415000W](#) [R124072220W](#)