

RECOMMENDED PCB LAYOUT
(TOLERANCE:±0.05)

NOTES :

1.0. RATING :

- 1.1. VOITAGE :60 VAC (R.M.S.)
- 1.2. NOMINAL CHARACTERISTIC IMPEDANCE: 50 Ohm
- 1.3. APPLICABLE FREQUENCY: DC ~ 6GHz
- 1.4. VSWR: 1.3 MAX. (DC~3GHz), 1.5 MAX. (3~6GHz)
- 1.5. TEMPERATURE :-40°C TO +85°C

- 2.0. ALL DIMENSIONS SHOULD BE CONTROLLED IN FAI:
- 3.0. MARKED ▽ SHOULD BE CONTROLLED BY QIP.:

MANUFACTURE DWG		 东莞市讯普电子科技有限公司 DongGuan XunPu Electronics Co.,Ltd	
UNLESS OTHERWISE SPECIFIED TOLERANCES		TITLE: MICRO RF IV BOARD SMT TYPE PACKING DWG	
		PAR	IPEX-004
DECIMALS:	ANGLES:	DWN	
X.X±0.20	.*±3.0°	CHKD	
X.XX±0.10	X.*±2.0°	APVD	
X.XXX±0.05	X.X*±1.0°	SCALE:1:1	UNIT:MM
CUSTOMER COPY		SIZE:A4	SHEET:1F1
			REV:A



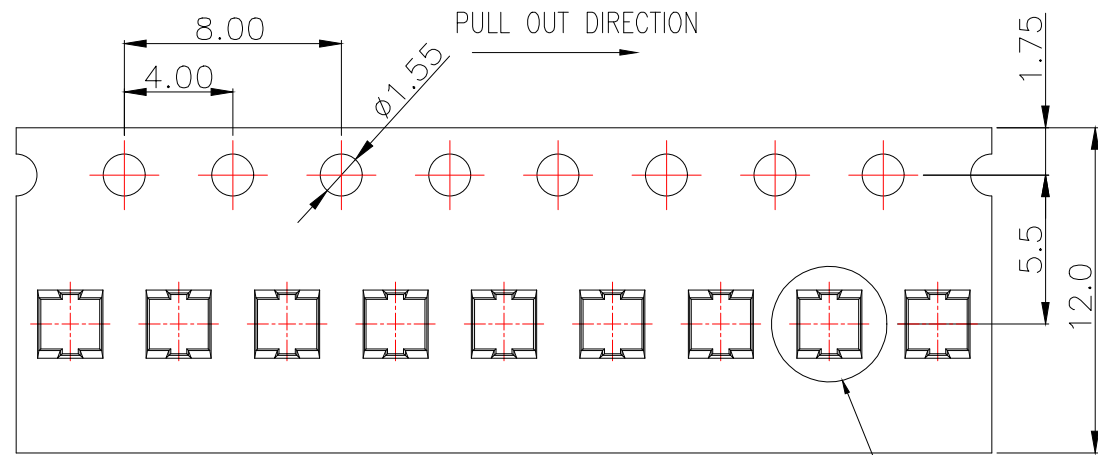

NOTES:

- MATERIAL :
 - 1.1 EMBOSSED CARRIER: PET
 - 1.2 COVER TAPE: PET
 - 1.3 SHIPPING CARTON: CORRUGATED FIBER
- DIMENSION :
 - 2.1 REEL: W=12.4
 - 2.2 SHIPPING CARTON: L=190, W=190, H=190
- PEELING RESISTANCE: 10gf~130gf.
- QUANTITY/WEIGHT :

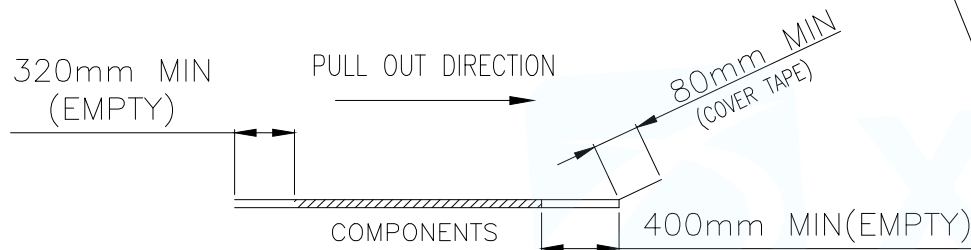

PART NO.	PRIMARY PACKING	SECONDARY PACKING	NET WEIGHT	GROSS WEIGHT
IPEX-004	3000PCS/REEL	30000PCS/BOX	0.18KG/REEL	2.00KG/BOX

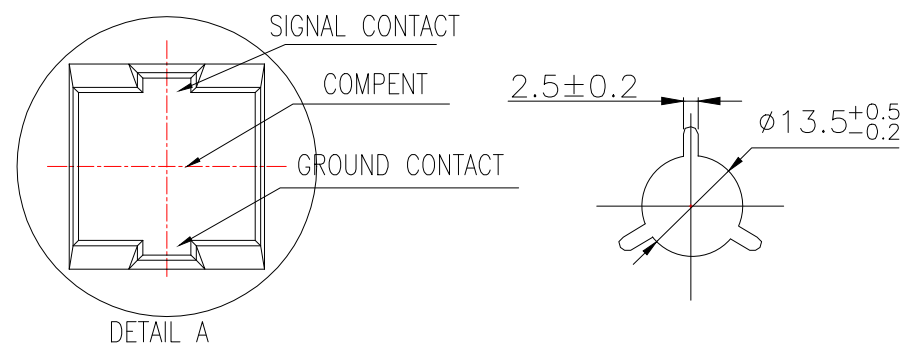
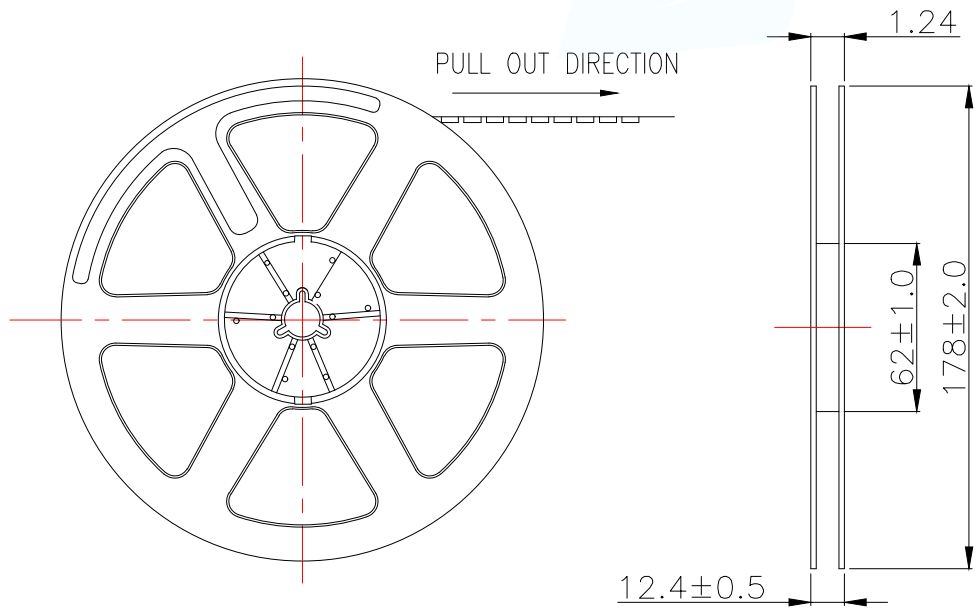

MANUFACTURE DWG		东莞市讯普电子科技有限公司 DongGuan XunPu Electronics Co.,Ltd	
UNLESS OTHERWISE SPECIFIED TOLERANCES		TITLE: MICRO RF IV BOARD SMT TYPE PACKING DWG	
		PAR	IPEX-004
		DWN	
		CHKD	
		APVD	
DECIMALS:	ANGLES:	SCALE:1:1	UNIT:MM
X.X±0.20	:±3.0°		
X.XX±0.10	X.*±2.0°	SIZE:A4	SHEET:1F1
X.XXX±0.05	X.X*±1.0°	CUSTOMER COPY	REV:A



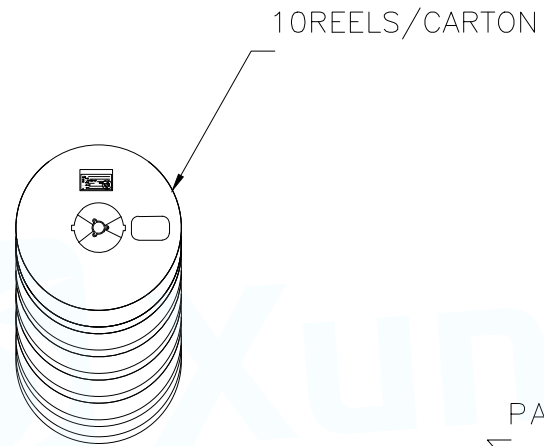
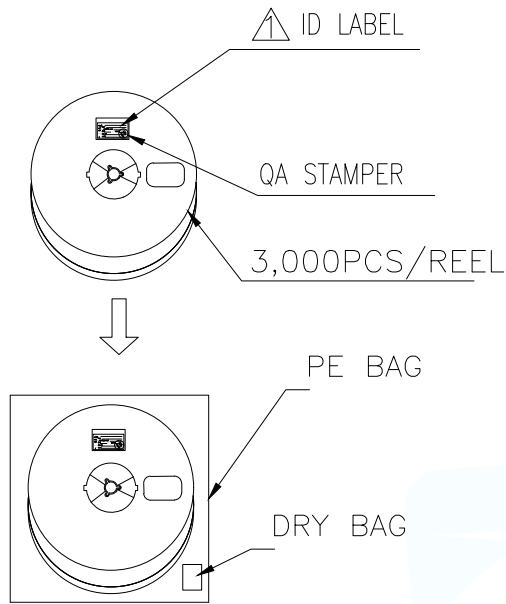

品名 NAME: _____

料号 PART No: _____

客户料号 CUSTOMER PART No: _____

数量 Q'TY: _____ 重量 WEIGHT: _____

批次 LOT No: _____

日期 DATE : _____

ID LABEL

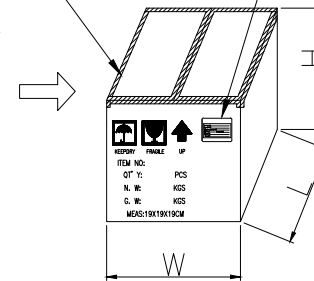
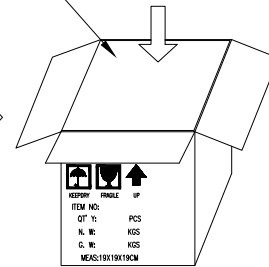
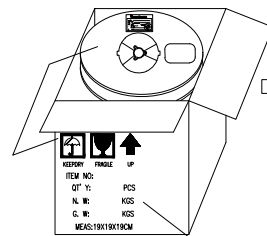
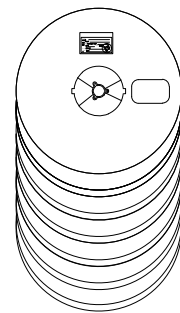

QT' Y: 30,000 PCS
N. W: 0.077 KGS
G. W: 1.033 KGS
MEAS:19X19X19CM

MANUFACTURE DWG		 东莞市讯普电子科技有限公司 DongGuan XunPu Electronics Co.,Ltd	
UNLESS OTHERWISE SPECIFIED TOLERANCES			TITLE: MICRO RF IV BOARD SMT TYPE PACKING DWG
			PAR IPEX-004
DECIMALS:	ANGLES:		DWN
X.X±0.20	.°±3.0°		CHKD
X.XX±0.10	X.°±2.0°	APVD	
X.XXX±0.05	X.X°±1.0°	CUSTOMER COPY	SCALE:1:1 UNIT:MM
		SIZE:A4	SHEET:1F1
			REV:A

X-ON Electronics

Largest Supplier of Electrical and Electronic Components

Click to view similar products for [RF Connectors](#) / [Coaxial Connectors](#) category:

Click to view products by [XUNPU](#) manufacturer:

Other Similar products are found below :

[8915-1511-000](#) [89674-0827](#) [6002-7051-003](#) [6059674-1](#) [630059-000](#) [M39030/3-01N](#) [6501-1071-002](#) [6769](#) [7002-1572-002](#) [7003-1542-011](#)
[7003-1572-002](#) [7004-1512-000](#) [7009-1511-004](#) [7101-1541-010](#) [7105-1521-002](#) [7145-1521-002](#) [7203-1571-003](#) [7209-1511-011](#) [7210-1511-](#)
[040](#) [7242-1511-000](#) [73216-2241](#) [73404-2300](#) [7405-1521-005](#) [7405-1521-802](#) [8527](#) [8547](#) [FS11V](#) [877931](#) [8808-1511-001](#) [9074-9513-000](#)
[PL11C-026](#) [PL40-36](#) [PL71-9](#) [PL74C-221](#) [9408-1113-000](#) [980-8666-005](#) [1200690078](#) [1-201144-1](#) [120919](#) [R107003010W](#) [R112186000](#)
[R113053000W](#) [R113082097](#) [R113236000](#) [R113240000](#) [R113240097](#) [R114083000](#) [R114670000W](#) [R123415000W](#) [R124072220W](#)