

NOTES:

- PRODUCT SPECIFICATIONS:
 VOLTAGE RATING: 10V
 CURRENT RATING: 0.3A
 INSULATION RESISTANCE: 1000 MEG.OHM MIN
 CONTACT RESISTANCE: INITIAL 50mΩ Max;AFTER TEST ΔR=25mΩ
 OPERATION TEMPERATURE: -40° TO +85°
 DURABILITY: 3000 CYCLES

8	HOOK	THERMOPLASTIC UL94 V-0	2	NO PLATING, BLACK MOISTURE PROOF GRADE:2a
7	DETECT SWITCH	COPPER ALLOY	1	15u"Min Au PLATING ON CONTACT AREA, 3u"Min Au PLATING ON SOLDER TAILS, Ni UNDERPLATING OVERALL
6	DETECT LEVER	COPPER ALLOY	1	Ni UNDERPLATING OVERALL
5	EJECT LEVER	STAINLESS STEEL	1	NO PLATING
4	EJECT BAR	STAINLESS STEEL	1	NO PLATING
3	SHELL	STAINLESS STEEL	1	3u"Min Au PLATING ON SOLDER TAILS, Ni UNDERPLATING OVER ALL
2	CONTACT	COPPER ALLOY	1	Au PLATING ON CONTACT AREA(SEE P/N) 3u"Min Au PLATING ON SOLDER TAILS, Ni UNDERPLATING OVER ALL
1	HOUSING	THERMOPLASTIC UL94 V-0	1	BLACK COLOR, MOISTURE PROOF GRADE:2c
ITEM	NAME	MATERIAL	Q'TY	REMARK

MANUFACTURE DWG		东莞市讯普电子科技有限公司 DongGuan XunPu Electronics Co.,Ltd		
UNLESS OTHERWISE SPECIFIED TOLERANCES			TITLE: 1.35H 3选2 卡座 FOR CUSTOMER	
DECIMALS:	ANGLES:		PAR	MCS-302S-C1
X.:±0.25	XX':±3°		DWN	YAO
X.X:±0.20	X.':±2'		CHKD	
X.XX:±0.15	.X':±1'		APVD	
CUSTOMER COPY		SCALE: 1:1	UNIT: MM	
		SIZE: A4	SHEET: 1F1	
			REV: A	

12	13	14	15
MAPX	MODIFICATION	DATE	APPROVE

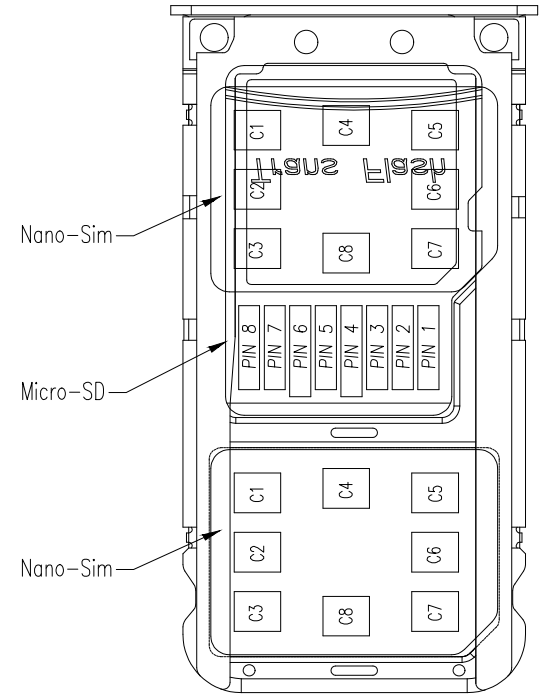
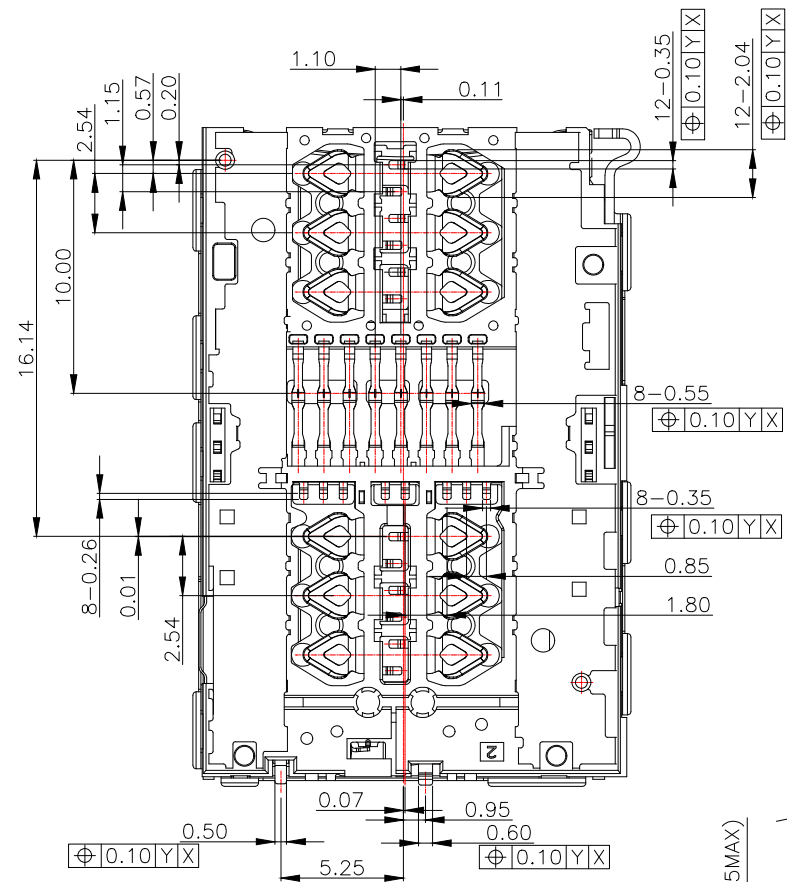
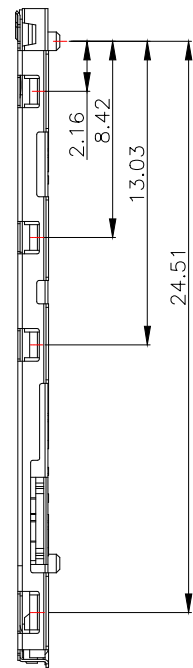

BOTTOM VIEW

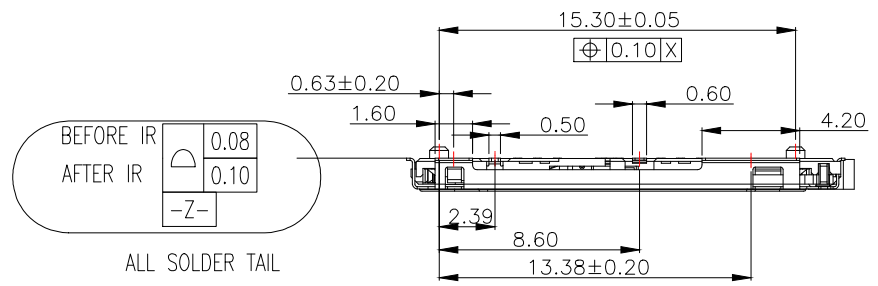
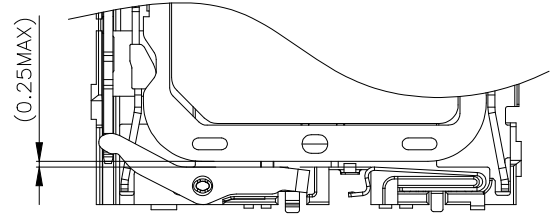

MANUFACTURE DWG		东莞市讯普电子科技有限公司 DongGuan XunPu Electronics Co.,Ltd	
UNLESS OTHERWISE SPECIFIED TOLERANCES			TITLE:1.35H 3卷2 卡座 FOR CUSTOMER
DECIMALS:	ANGLES:		PAR MCS-302S-C1
X.:±0.25	XX':±3°		DWN YAO
X.X:±0.20	X.':±2°		CHKD
X.XX:±0.15	.X':±1°	APVD	UNIT:MM
CUSTOMER COPY		SCALE1:1	SIZE:A4
		SHEET:1F1	REV:A

MAPX	MODIFICATION	DATE	DRAW	APPROVE

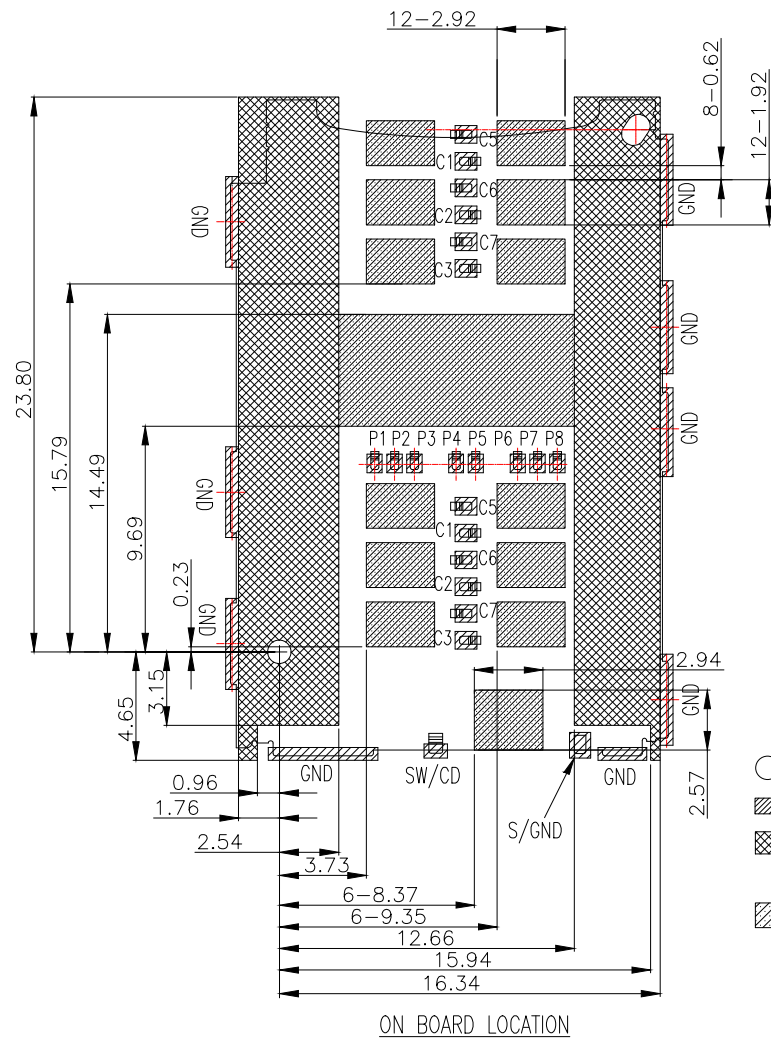

- Through Hole
 - ▨ Soldering Pad Area
 - ▩ Open Wire Restricted Area
(Possibility Touch Of Components On PCB)
 - ▧ No Soldering Pad Area(Independent Pad Area)
OR Open Wire&Copper Restricted Area
- 1:Touch area of contact tips, No electrical function and only for mechanical function.
2:No first PCB-Layout circuits in the area.

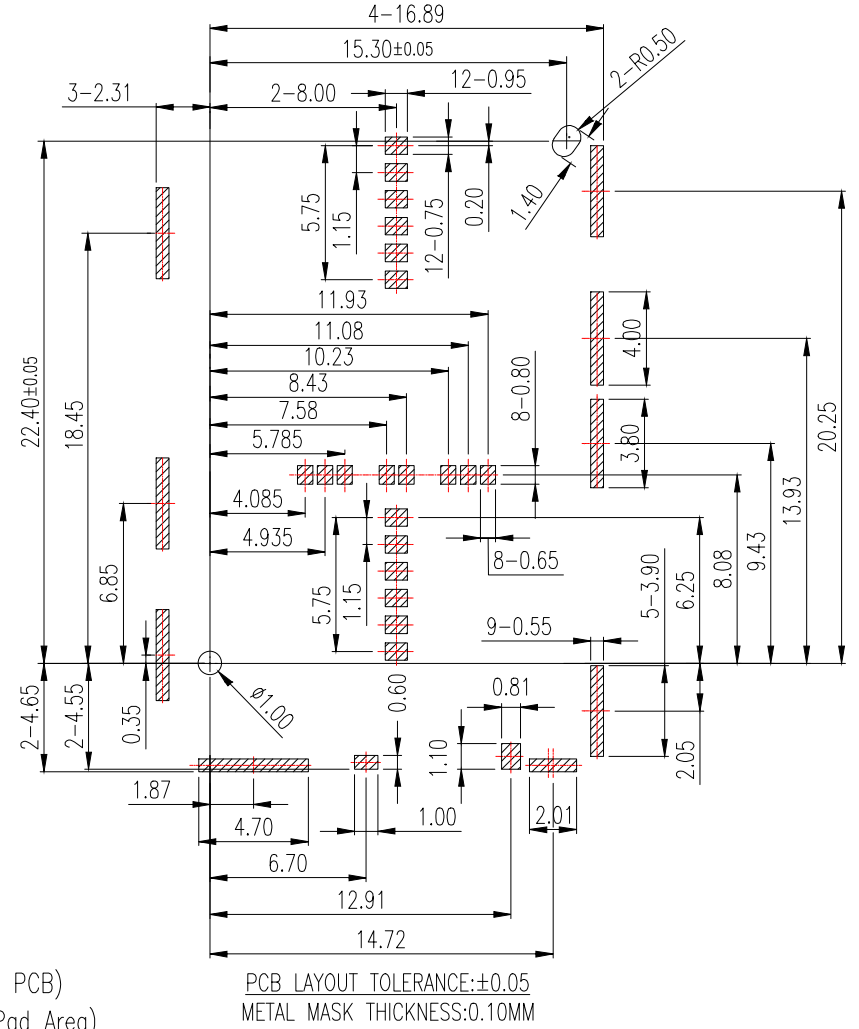

MANUFACTURE DWG		东莞市讯普电子科技有限公司 DongGuan XunPu Electronics Co.,Ltd		
UNLESS OTHERWISE SPECIFIED TOLERANCES			TITLE:1.35H 3选2 卡座 FOR CUSTOMER	
DECIMALS:	ANGLES:		PAR	MCS-302S-C1
X.:±0.25	XX.:±3°		DWN	YAO
X.X:±0.20	X.:±2°		CHKD	
X.XX:±0.15	.X.:±1°	APVD		
CUSTOMER COPY		SCALE:1:1	UNIT:MM	
		SIZE:A4	SHEET:1F1	REV:A

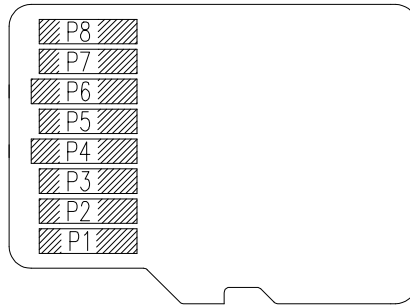
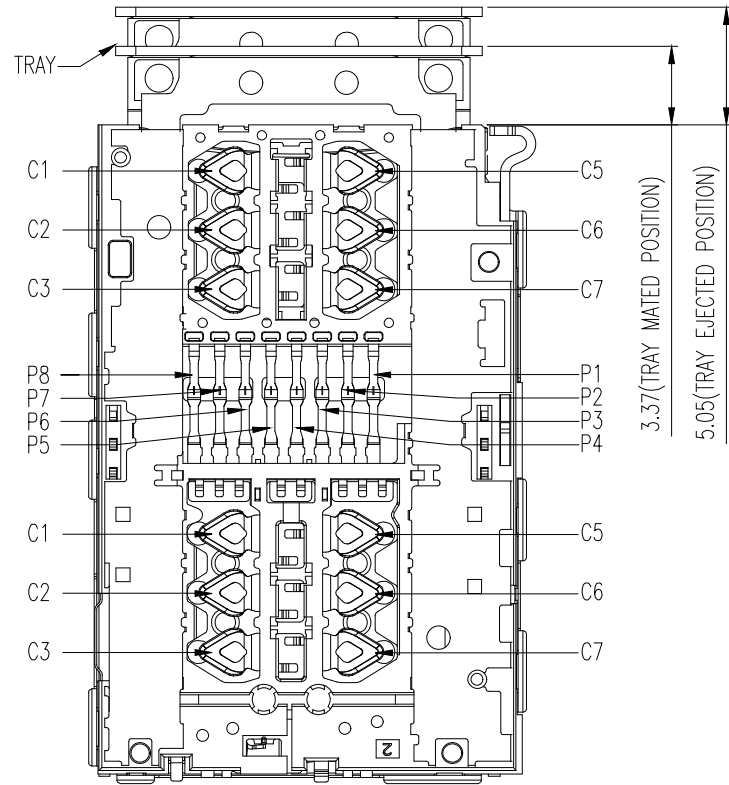

Micro SD CARD ELECTRICAL

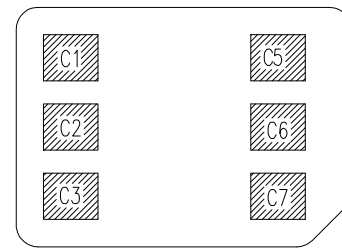

NANO SIM CARD ELECTRICAL

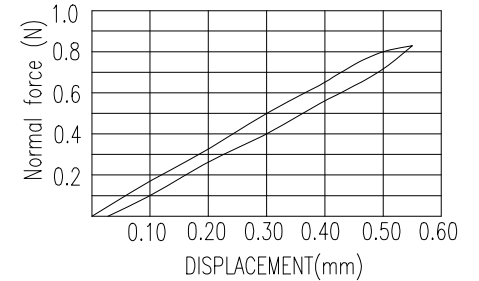

Nano Sim card Contact NF-Deflection Curve

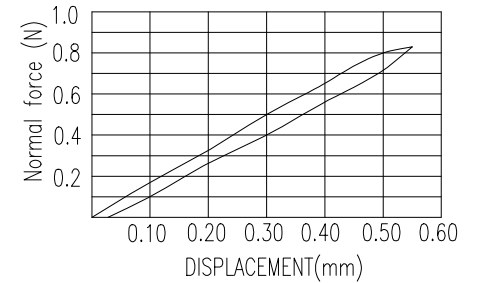

Nano Sim card Contact NF-Deflection Curve

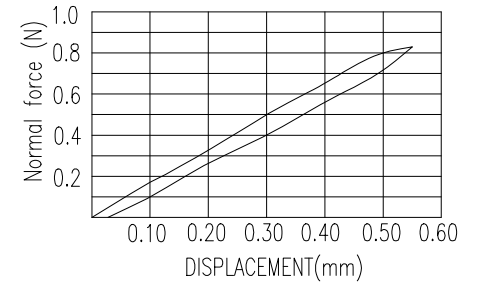

Nano Sim card Contact NF-Deflection Curve

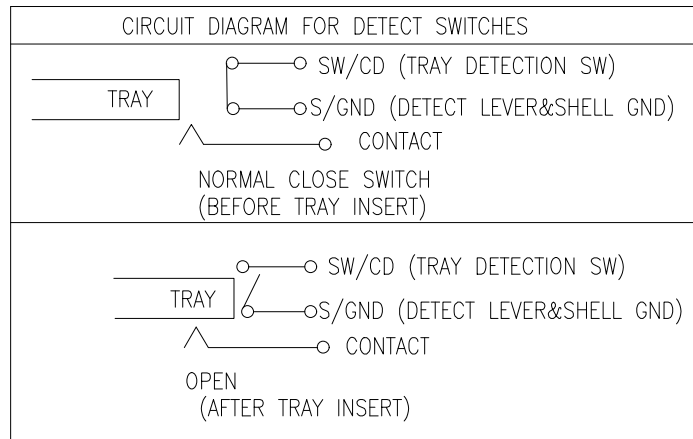

ITEM	FUCTION
Micro SD CARD	
P1	DAT2 OF MSD
P2	CD/DAT3 OF MSD
P3	CMD OF MSD
P4	VDD OF MSD
P5	CLK OF MSD
P6	VSS OF MSD
P7	DATO OF MSD
P8	DAT1 OF MSD
NANO SIM CARD	
C1	VCC OF SIM
C2	RST OF SIM
C3	CLK OF SIM
C5	GND OF SIM
C6	VPP OF SIM
C7	DATA OF SIM

MANUFACTURE DWG		东莞市讯普电子科技有限公司 DongGuan XunPu Electronics Co.,Ltd	
UNLESS OTHERWISE SPECIFIED TOLERANCES		TITLE:1.35H 3选2 卡座 FOR CUSTOMER PAR MCS-302S-C1 DWN YAO CHKD APVD SCALE 1:1 UNIT:MM SIZE:A4 SHEET:1F1 REV:A	
DECIMALS:	ANGLES:		
X.:±0.25	XX.:±3°		
X.X:±0.20	X.:±2°		
X.XX:±0.15	.X.:±1°		
CUSTOMER COPY			

X-ON Electronics

Largest Supplier of Electrical and Electronic Components

Click to view similar products for [Memory Card Connectors](#) category:

Click to view products by [XUNPU](#) manufacturer:

Other Similar products are found below :

[M21-033321-005](#) [6407-249V-25273P](#) [6407-249V-25343P](#) [69.920.0553.0](#) [809180410000000](#) [DM3AT-SF-PEJM5\(41\)](#) [HMCAP001](#) [252-0144-000](#) [2041353-2](#) [308-DS1P0811-192](#) [33CFAE-DN](#) [HM2P09PDR360N9LF](#) [502431-1011](#) [11327-001](#) [11327-002](#) [95622-003LF](#) [N7E50-U516RB-50-SIN0005](#) [95079-00CALF](#) [84648-056HLF](#) [93-570123-08P](#) [125A-78C00](#) [MI20A-50PD-SF-EJL\(71\)](#) [KP10S-SF-PEJ\(812\)](#) [504536-0691](#) [CCM03-3109 B LFT](#) [MI21-50PD-SF\(91\)](#) [2309923-1](#) [61126-050CAHLF](#) [IC1GA-68PD-1.27DS-EJ\(72\)](#) [GTFP08432B1HR](#) [G85DT17001P1EU](#) [G85C11101152HHR](#) [G85D1160022HHR](#) [KP15TL-SF\(800\)](#) [KP10BH-8S-SF\(800\)](#) [SCE2MSDB76A121SN](#) [SCE2MSDZN76A121SN](#) [C00710B0250001](#) [CCM01-2664 LFT T25](#) [47309-2651](#) [47481-0001](#) [055036006202862+](#) [67799-0004](#) [91228-3006](#) [104168-1616](#) [104C-TAA1](#) [112I-TA01](#) [112K-TAA0-RA1](#) [115S-ACA2](#) [115S-ACA3](#)