

NOTES

- MATERIAL**
- HOUSING MATERIAL: THERMO PLASTICS UL94V-0.
 - CONTACT MATERIAL: PHOSPHOR BRONZE T=0.25mm. SELECT GOLD PLATING ON CONTACT AREA AND TIN PLATING ON SOLDER AREA OVER NICKEL.
 - SHIELD: STAINLESS T=0.20mm NI PLATING.
 - GASKET: SPCC T=0.40 NI PLATING.
 - LED: TIN PLATING.
- MELECTRICAL**
- VOLTAGE RATING: 125 VAC RMS.
 - CURRENT RATING: 1.5 AMP.
 - CONTACT RESISTANCE: 40 MILLIOHMS MAX.
 - INSULATION RESISTANCE: 500 MEGOHMS MIN @ 100V DC.
 - DIELECTRIC DIELECTRIC RESISTANCE: 500V DC RMS 50Hz. 1MIN.
- MECHANICAL**
- DURRABILITY: 750 CYCLES MIN.
 - MATING/UNMATING FORCE: 2.24 KG.F MAX.
- ENVIRONMENTAL:**
- STORAGE: -40℃~+85℃.
 - OPERATION: -40℃~+85℃.

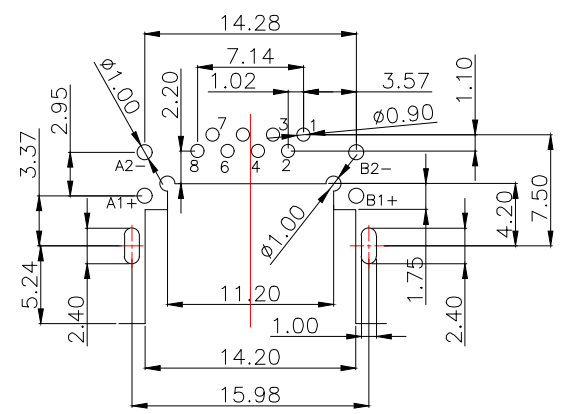
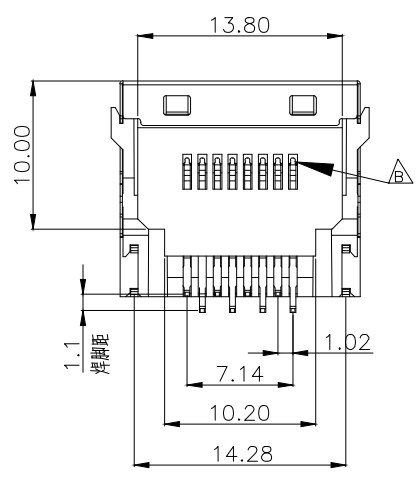
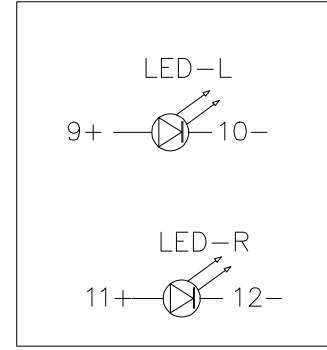
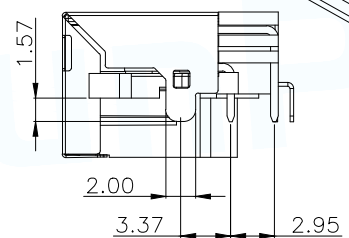
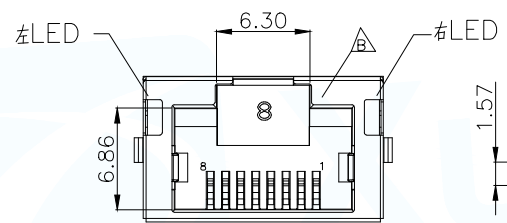
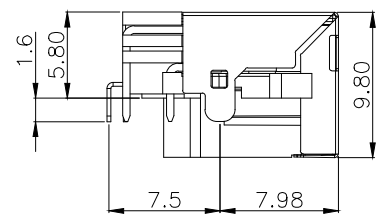
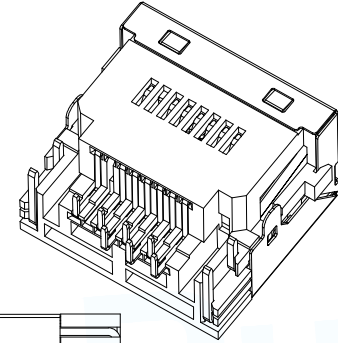
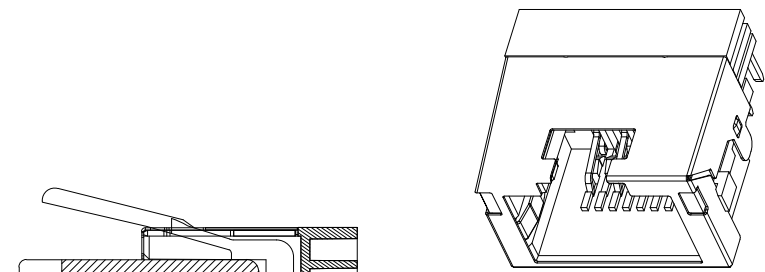
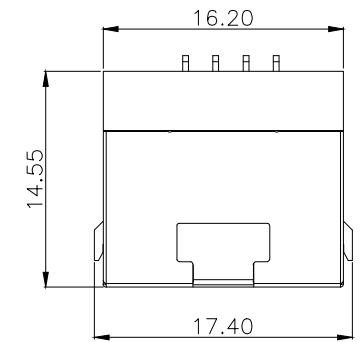

PCBLAYOUT T=1.2
TOL:±0.05

8	—
7	—
6	RX-
5	—
4	—
3	RX+
2	TX-
1	TX+
PIN	说明

Node		
A1(+)	A2(-)	A1-LED-A2
B1(+)	B2(-)	B1-LED-B2

MANUFACTURE DWG		东莞市讯普电子科技有限公司 DongGuan XunPu Electronics Co.,Ltd	
UNLESS OTHERWISE SPECIFIED TOLERANCES			TITLE: RJ45 沉板5.8 DIP带壳带灯
			PAR RJ45-005-202-11
DECIMALS:	ANGLES:		DWN
.X:±0.35	X':±3'		CHKD
.XX:±0.25	.X':±2'	APVD	
.XXX:±0.15	.XX':±1'	CUSTOMER COPY	SCALE:1:1 UNIT:MM
		SIZE:A4	SHEET:1F1
			REV:A

X-ON Electronics

Largest Supplier of Electrical and Electronic Components

Click to view similar products for [Modular Connectors](#) / [Ethernet Connectors](#) category:

Click to view products by [XUNPU](#) manufacturer:

Other Similar products are found below :

[8949-H88/06BLKA/SN](#) [74441-0010/BKN](#) [PHP-6P6C-5](#) [GAX-3-66](#) [GDCX-PN-66](#) [GLX-A-44](#) [GLX-N-1010M-BLK](#) [GLX-S-88M-BLK](#)
[GMX-SMT4-N-88](#) [GSGX-N-2-88](#) [GSGX-N-4-88](#) [GSX-NS2-88-3.05](#) [GSX-NS-88-3.68](#) [PT-108A-8C-UL](#) [PTS-J531-8CS-50UL](#) [A-2014-0-4](#)
[GWLX-S9-88-YG](#) [DC-1021-8-WH-6](#) [1300530003](#) [1324640-4](#) [132764-001](#) [1413235](#) [MPS88RX-5000](#) [E5288-S000K3-L](#) [155302-001](#)
[AX101050](#) [AX101063](#) [AX101065](#) [AX101072](#) [AX101307](#) [AX101315](#) [AX101318](#) [AX102271](#) [AX102277](#) [AX102651](#) [AX102660](#) [AX104024](#)
[203475](#) [J0026D01ENL](#) [PC4D0018P](#) [KIT38082NI](#) [8949-B88/6](#) [2-6609208-5](#) [30-8956](#) [30-8964-100](#) [SM85](#) [17-103540](#) [191587](#) [PDI-68-RV](#)
[PHP-8P8C-S-5](#)