

MATERIAL:
 INSULATOR: HIGH TEMPERATURE THERMOPLASTIC, UL 94V-0
 CONTACT: COPPER ALLOY
 SHELL: SUS

PLATING:
 CONTACT: PLATED 50U" NI OVER ALL CONTACT AU 1U
 SHELL: PLATED 50U" NI OVERALL
 PLATED 1U" AU SELECTIVE CONTACT AREA

ELECTRICAL:
 CURRENT RATING: 0.5AMPS MAX
 VOLTAGE RATING: 5V AC/DC
 AMBIENT TEMPERATURE RANGE: -40℃ ~ +85℃
 STORAGE TEMPERATURE RANGE: -40℃ ~ +85℃
 AMBIENT HUMIDITY RANGE: 95% R.H. MAX.
 CONTACT RESISTANCE: 100M MAX.Ω
 INSULATION RESISTANCE: 1000M MIN./500VDCΩ
 REFLOW PEAK TEMP: 260℃
 MATING CYCLES: 5000MIN INSERTIONS

NANO SIM CARD	
Pin No.	NAME
C1	VCC OF SIM
C2	RST OF SIM
C3	CLK OF SIM
C5	GND OF SIM
C6	VPP OF SIM
C7	I/O OF SIM
C4/C8	N/A
CD	DETECTION SWITCH

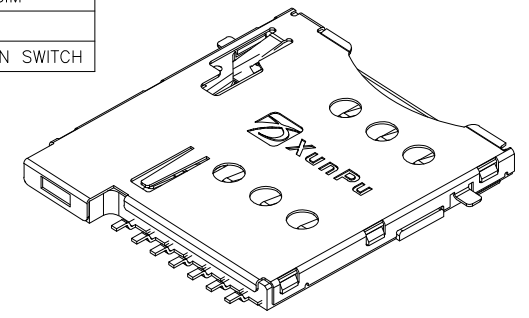

MANUFACTURE DWG		东莞市讯普电子科技有限公司 DongGuan XunPu Electronics Co., Ltd	
UNLESS OTHERWISE SPECIFIED TOLERANCES		TITLE: MICRO SIM CARD PUSH PUSH 6+1PIN H1.35 正视	
DECIMALS: X.X:±0.15		PAR	SMC-202-7SC
ANGLES:±1°		DWN	YAO
X.XX:±0.10		CHKD	
X.XXX:±0.05		APVD	
CUSTOMER COPY		SCALE 1:1	UNIT:MM
		SIZE:A4	SHEET:1F1
			REV:A

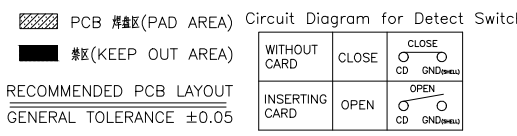
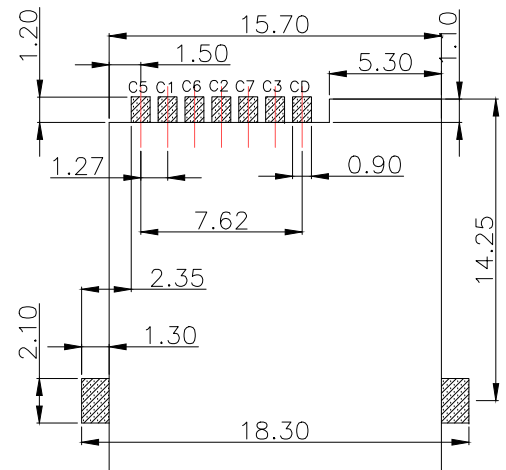
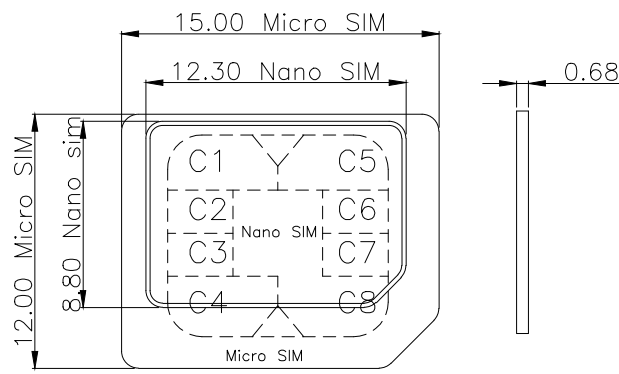
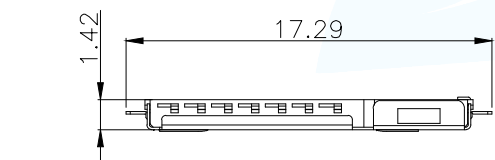
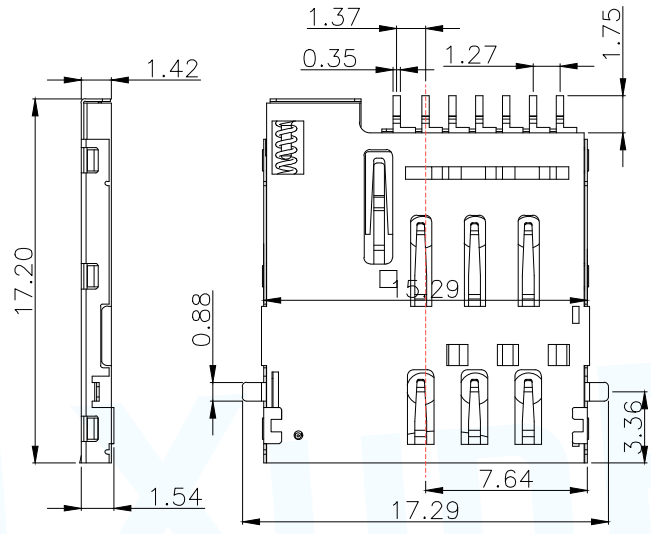
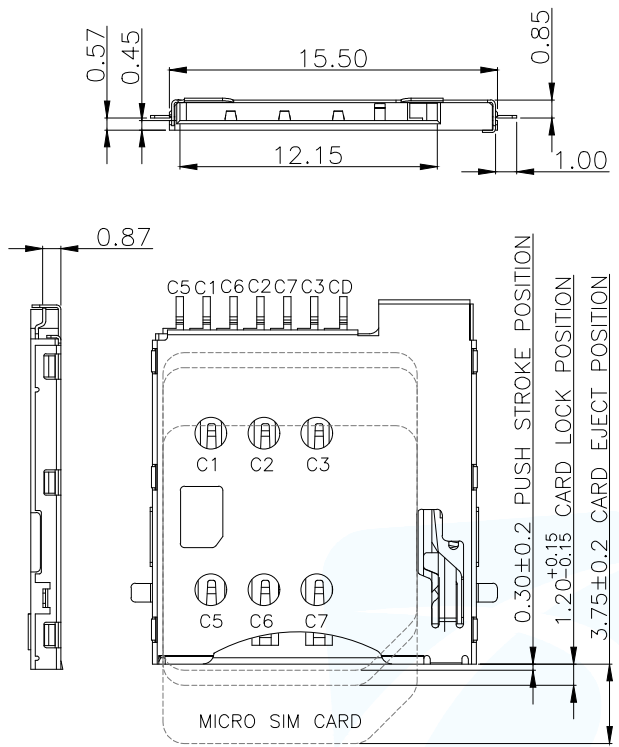

X-ON Electronics

Largest Supplier of Electrical and Electronic Components

Click to view similar products for [Standard Card Edge Connectors](#) category:

Click to view products by [XUNPU](#) manufacturer:

Other Similar products are found below :

[CR7E-30DB-3.96E\(72\)](#) [6565204-6](#) [1437274-4](#) [EBT15622B2X](#) [1-582587-1](#) [284-0102-12100](#) [286-0052-12101A](#) [306022901000000](#) [307-012-502-202](#) [307-056-520-300](#) [A6D22DS29C2](#) [1926088-2](#) [287-0032-12101](#) [345-060-559-303](#) [392-008-559-201](#) [534671-1](#) [341-240-317](#) [345-044-500-300](#) [346-240-318](#) [387-012-523-300](#) [395-100-524-300](#) [09-07-2032](#) [10035388-802LF](#) [10115859-011LF](#) [10122859-009LF](#) [101269333204245CLF](#) [530555-1](#) [66925-516LF](#) [5145409-2](#) [73726-0005](#) [66308-1](#) [5036A30](#) [PEC-07-02-T-S-A](#) [346-014-520-801](#) [KSLX-62-BR](#) [307-048-502-202](#) [CE100F26-7-C](#) [CE100F28-3-D](#) [CE100F28-4-D](#) [CE156F18-9-C](#) [CE156F22-5-D](#) [CE156F22-9-C](#) [CT100F22-2-D](#) [CT100F22-3-D](#) [CT100F24-2-D](#) [CT100F24-3-D](#) [CT100F24-6-C](#) [CT156F22-4-D](#) [MLSS100-12-C](#) [MLSS100-16-C](#)