



SMN-301-ARP7
W12.30xD10.10xH1.25

PIN 数(Number of contacts) : 6+1PIN

耐电压(Withstand voltage) : 500V AC for 1 min

操作方式(Operation mode): 推拉式/PUSH PULL

操作寿命(Operation life): 5,000 Cycles Min

温度范围(Operating temp): -40°C TO +80°C

焊接温度(Welding temperature): 260±5° 5s

额定负荷(Rated load): 0.5A PER IN.

焊接方式(Welding mode): 贴片式/SMT

接触电阻(Contact resistance): 100mΩ max.

包装方式(Packaging method): 卷带/Tape & Reel (TR)

绝缘电阻(Insulation resistance): 1000MΩ min.

最小包装(Minimum packing): 2,200/PCS

外形尺寸 (UNIT:MM) / Size Chart

www.xunpudianzi.com

更多资料请参考技术选型档!

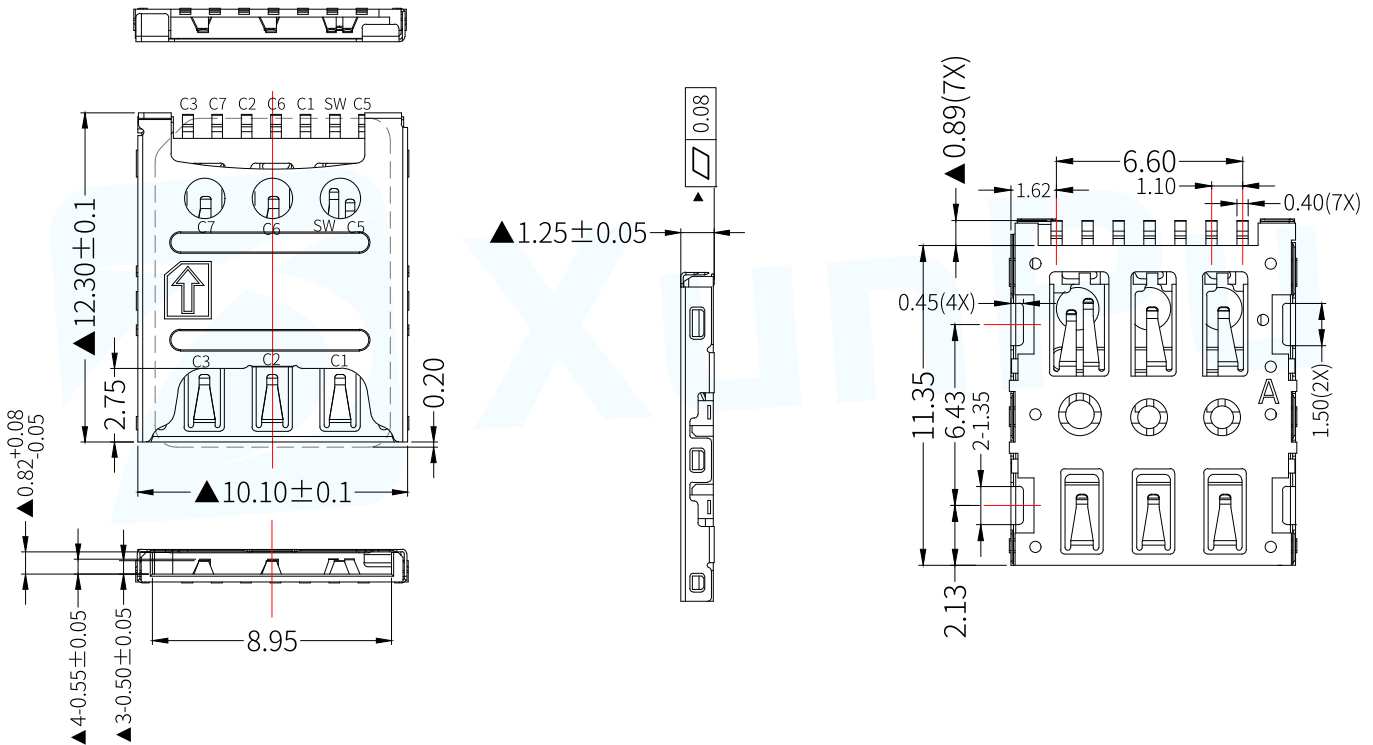

NOTES

- MATERIAL:
 - HOUSING: THERMOPLASTIC, UL 94-V0
 - TERMINAL: PHOSPHOR BRONZE, T=0.10
 - SHELL: STAINLESS STEEL, T=0.10
- FINISHED:
 - TERMINAL: Ni PLATED UNDER, Au PLATED ON CONTACT AREA, G/F PLATED ON SOLDER TAIL
 - SHELL: Ni PLATED UNDER, G/F PLATED ON SOLDER TAIL

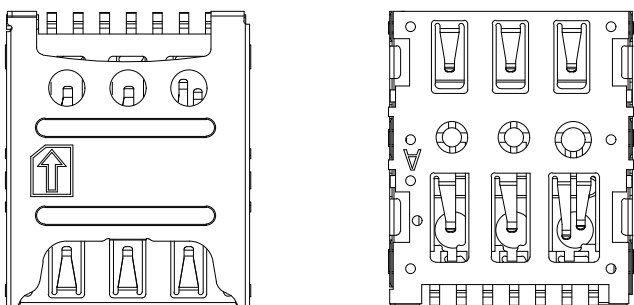
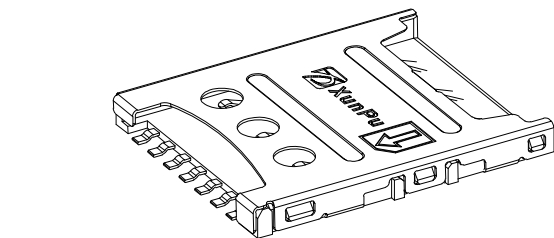

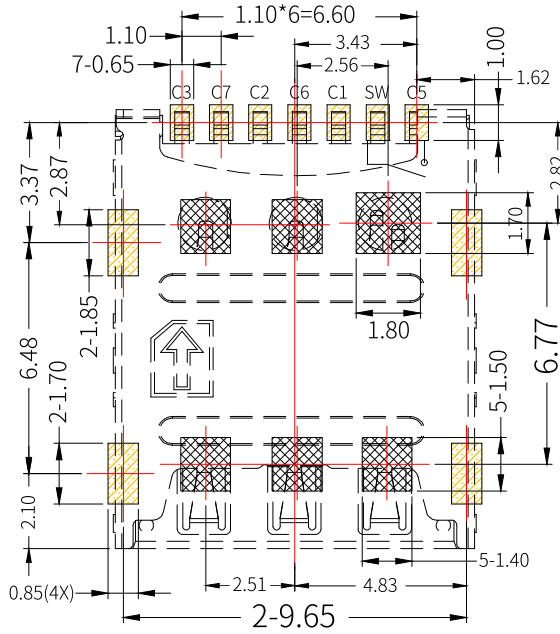

Circuit Diagram for Detect Switch

PCB焊盘区(PAD AREA)
 禁区(KEEP OUT AREA)
RECOMMENDED PCB LAYOUT
 GENERAL TOLERANCE ± 0.05

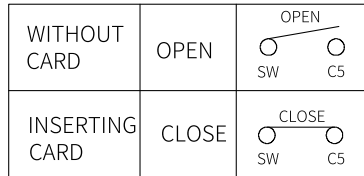

● NANO SIM

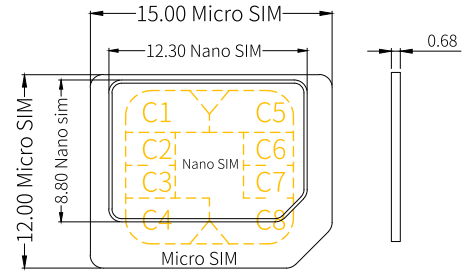

● 引脚定义/Pin Definition

SIM PIN ASSIGNMENT			
PIN#	NAME	TYPE	DESCRIPTION
C1	供电电压	1	VCC
C2	重置	1	RST
C3	时钟	1	CLK
C5	接地	1	GND
C6	程序电压	1	VPP
C7	输入输出	1	I/O
SW	卡检测开关		Card Detect Switch

焊接条件 / Welding conditions

● 回流焊/Reflow soldering

适用表面贴装型产品/Applicable to surface mount products
温度分布/Temperature distribution

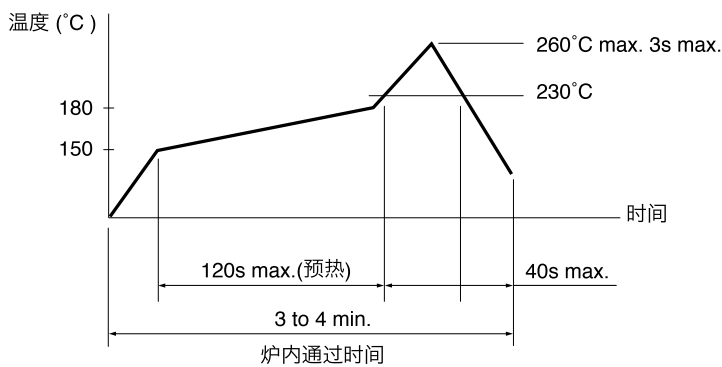

● 手焊式/Hand welding

项目/Project	条件/condition
焊接温度 Welding temperature	350°C max.
持续焊接时间 Continuous welding time	3s max.
焊剂斗容量 Flux bucket capacity	60W max.

● 浸焊式/Immersion soldering

项目/Project	条件/condition
助焊剂附着量 Flux adhesion	不附着于零部件贴装面的程度 Not attached to the mounting surface of components
预热温度 Preheating temperature	印刷电路板焊接面的周围温度 100°C max. The temperature around the welding surface of PCB is 100 °C max
预热温度时间 Preheat temperature time	60s max.
焊接温度 welding temperature	260°C max.
焊接浸渍时间 Welding immersion time	5s max.
焊接次数 Welding times	2 times max.

注:

1. 加热方式:以远红外线上下加热方式。
2. 温度测量:用 $\Phi 0.1\sim 0.2$ 的 CA(K)或 CC(T)测量位置在焊接连接部(锡/铜箔面)。
3. 固定方式:采用耐热胶带。

X-ON Electronics

Largest Supplier of Electrical and Electronic Components

Click to view similar products for [Memory Card Connectors](#) category:

Click to view products by [XUNPU](#) manufacturer:

Other Similar products are found below :

[M10-597810-355](#) [M21-033321-005](#) [6426-201-21343](#) [69.920.0553.0](#) [MCR60A-98D-2.54DSA\(70\)](#) [FCN-568P068-G/07-4V](#) [809180410000000](#)
[95622-003LF](#) [AD2-262F-38900-232](#) [DM3AT-SF-PEJM5\(41\)](#) [EN2997S72039F6](#) [N7E50-7516PG-20-WF](#) [IC11S-BUR-PNEJL\(71\)](#) [NX30TA-](#)
[15PAA\(50\)](#) [21920-5](#) [2041353-2](#) [FUA006-3220-0](#) [308-DS1P0811-192](#) [33CFAE-DN](#) [MI21A-50PD-SF-EJR\(91\)](#) [502431-1011](#) [5175651-2](#) [10-](#)
[247926-166](#) [10-629549-258N](#) [11327-001](#) [11327-002](#) [EN2997S02039B8](#) [EN2997S61212BN](#) [EN2997S72039B6](#) [EN2997SE02039B8](#)
[EN2997SE61212BN](#) [EN2997SE72039B6](#) [603020000](#) [617230001](#) [71-252718-32P](#) [NX1-32T-KT3K\(05\)](#) [95622-003LF](#) [91-570124-15P](#)
[192900-0488](#) [N7E50-U516RB-50-SIN0005](#) [DM1AA-SF-PEJ](#) [95079-00CALF](#) [84648-056HLF](#) [68-580163-21S](#) [33DVIR-29S12R](#)
[SF58S006VBBR2000](#) [93-570123-08P](#) [GMC020080HR](#) [125A-78C00](#) [1010040575#](#)