

Specification:

- Electrical Characteristics:
  - Contact Current Rating:0.5 Amperes.
  - Dielectric Withstanding Voltage:AC500V r.m.s.
  - Insulation Resistance:1000 MΩ Minimum.
  - Contact Resistance:40 mΩ Maximum.
- Environmental:
  - Operating Temperature:-25°C~+90°C.
- Environmental:
  - Mating Cycles:5,000 Insertions.
- Mechanical Characteristics:
  - Card Push Insertion/Out Force:0.2~1.40kgf.
  - Contact Separation Force:0.20kgf Minimum.
- Material:
  - Insulator:HI-Temp Plastic UL 94V-0 Rated.
  - Contact:Copper Alloy(t=0.15mm).
  - Shell:Stainless Steel(t=0.15mm).
  - Spring:SWP.

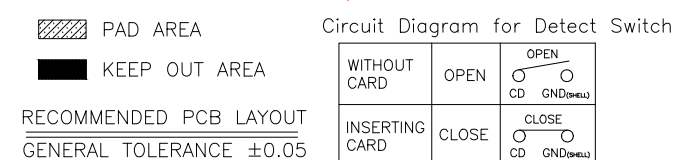
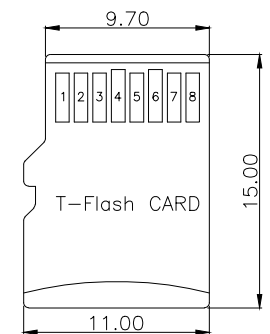
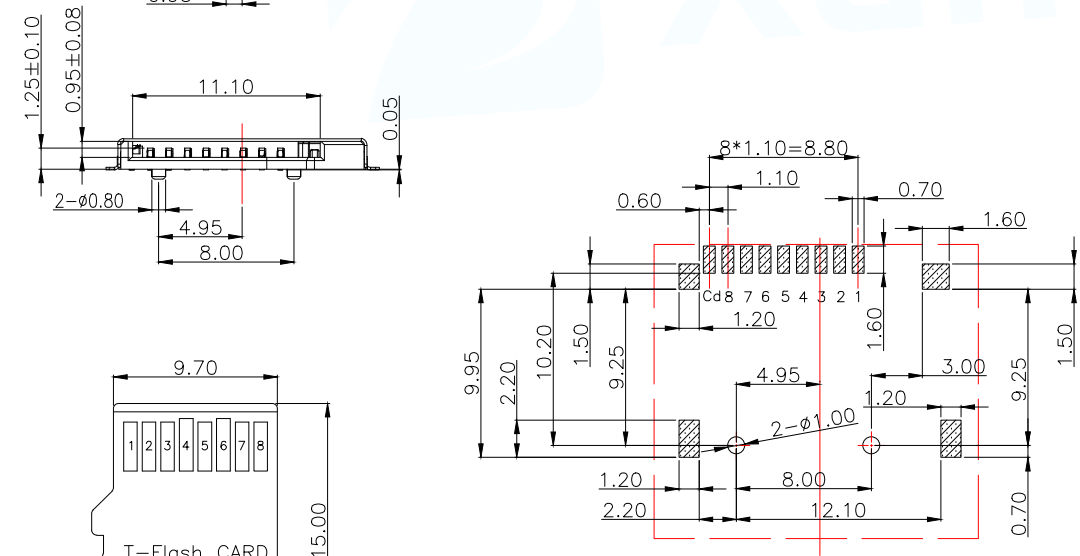
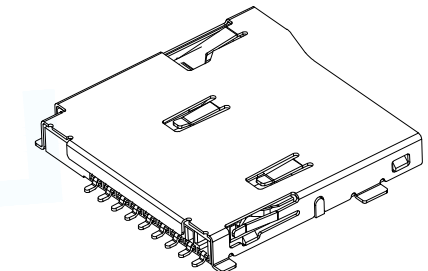

| TF CARD PIN DEFINE |         |        |                            |
|--------------------|---------|--------|----------------------------|
| PIN NO.            | NAME    | YYPE   | DESCRIPTION                |
| 1                  | DAT2    | I/O/PP | DATE LINE(BIT2)            |
| 2                  | CD/DAT3 | I/O/PP | CARD DETECT DATE LIN(BIT3) |
| 3                  | CMD     | PP     | COMMAND RESPONSE           |
| 4                  | VDD     | S      | SUPPLY VOLTAGE             |
| 5                  | CLX     | I      | CLOCK                      |
| 6                  | VSS     | S      | SUPPLY VOLTAGE GROUND      |
| 7                  | DAT0    | I/O/PP | DATE LINE(BIT0)            |
| 8                  | DAT1    | I/O/PP | DATE LINE(DIT1)            |

|                                       |           |                                                     |                                                    |
|---------------------------------------|-----------|-----------------------------------------------------|----------------------------------------------------|
| MANUFACTURE DWG                       |           | 东莞市讯普电子科技有限公司<br>DongGuan XunPu Electronics Co.,Ltd |                                                    |
| UNLESS OTHERWISE SPECIFIED TOLERANCES |           |                                                     | TITLE:MICRO SD CARD PUSH<br>PUSH SMT 镀金 外焊 自弹式 双弹片 |
| DECIMALS:                             | ANGLES:   |                                                     | PAR TF-115YY-ACP9                                  |
| X.X:±0.35                             | X.X':±3°  |                                                     | DWN                                                |
| X.XX:±0.25                            | X.XX':±2° |                                                     | CHKD                                               |
| X.XXX:±0.15                           |           | APVD                                                | SCALE:1:1 UNIT:MM                                  |
| CUSTOMER COPY                         |           | SIZE:A4                                             | SHEET:1F1                                          |
|                                       |           |                                                     | REV:A                                              |

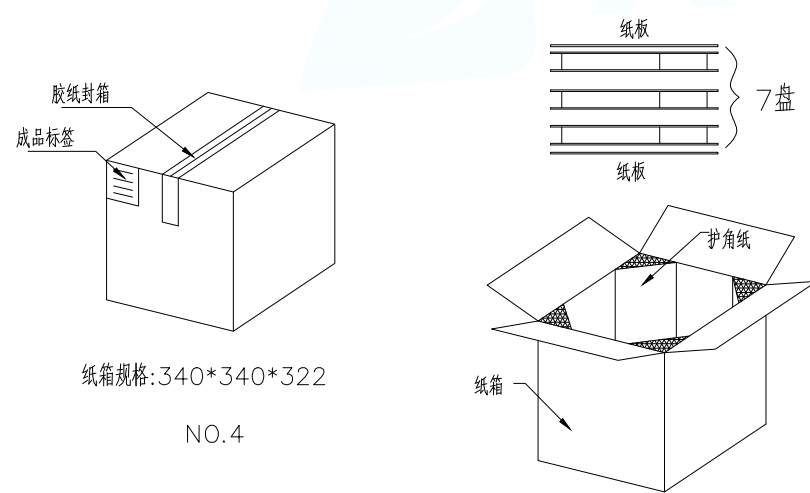
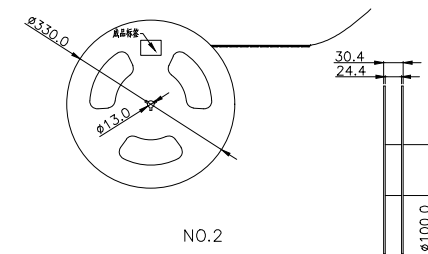
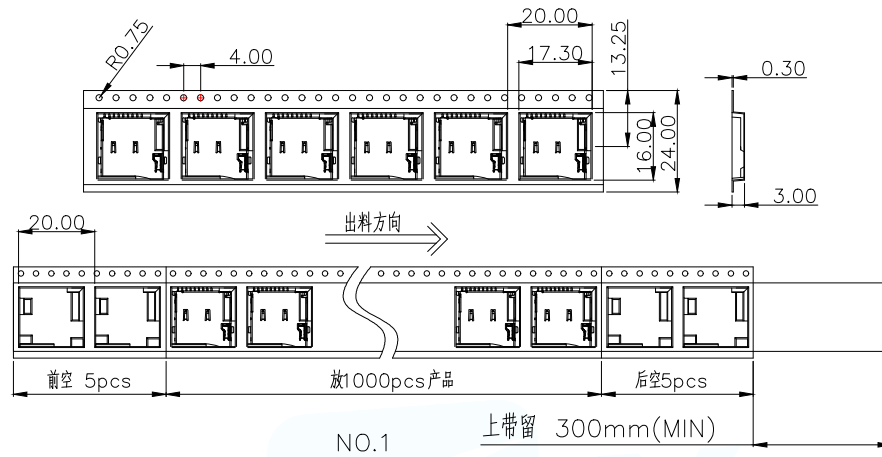

1. 材质要求:

- 1.1 纸箱的材质为K=K;外形尺寸为34\*34\*32.2;
- 1.2 卷盘的材质为PS,卷盘的外形尺寸为 $\phi 330 \times 30.4$ ;

2. 包装方式:

- 2.1 将卷带放入包装机后,前空5PCS,后放产品1000PCS,再后空5PCS;上带留300MM长度。
- 2.2 将包装好的产品从包装机上取下并包装好,贴上内盘标签;
- 2.3 把累叠好的7盘叠放入纸箱中共计7Kset,上下放纸板;
- 2.4 把包装好的成品打包封箱,并在纸箱外贴上标签

|                                       |           |                                                                                                                                           |                                                 |
|---------------------------------------|-----------|-------------------------------------------------------------------------------------------------------------------------------------------|-------------------------------------------------|
| MANUFACTURE DWG                       |           |  东莞市讯普电子科技有限公司<br>DongGuan XunPu Electronics Co.,Ltd |                                                 |
| UNLESS OTHERWISE SPECIFIED TOLERANCES |           |                                                      | TITLE:MICRO SD CARD PUSH PUSH SMT 镀金 外焊 自弹式 双弹片 |
| DECIMALS:                             | ANGLES:   |                                                                                                                                           | PAR TF-115YY-ACP9                               |
| X.X:±0.35                             | X.X':±3°  |                                                                                                                                           | DWN                                             |
| X.XX:±0.25                            | X.XX':±2° |                                                                                                                                           | CHKD                                            |
| X.XXX:±0.15                           |           | APVD                                                                                                                                      | SCALE 1:1 UNIT:MM                               |
| CUSTOMER COPY                         |           | SIZE:A4                                                                                                                                   | SHEET:1F1                                       |
|                                       |           |                                                                                                                                           | REV:A                                           |

## X-ON Electronics

Largest Supplier of Electrical and Electronic Components

*Click to view similar products for [Memory Card Connectors](#) category:*

*Click to view products by [XUNPU](#) manufacturer:*

Other Similar products are found below :

[M21-033321-005](#) [6407-249V-25273P](#) [6407-249V-25343P](#) [6426-201-21343](#) [69.920.0553.0](#) [MCR60A-98D-2.54DSA\(70\)](#) [809180410000000](#)  
[DM3AT-SF-PEJM5\(41\)](#) [IC11S-BUR-PNEJL\(71\)](#) [252-0144-000](#) [2041353-2](#) [308-DS1P0811-192](#) [HM2P09PDR360N9LF](#) [10014744-011TLF](#)  
[11327-001](#) [11327-002](#) [617230001](#) [NX1-32T-KT3K\(05\)](#) [N7E50-U516RB-50-SIN0005](#) [68-580163-21S](#) [125A-78C00](#) [CCM03-3109 B LFT](#)  
[2309923-1](#) [61126-050CAHLF](#) [IC1GA-68PD-1.27DS-EJ\(72\)](#) [GTFP08432B1HR](#) [SCE2MSDZN76A121SN](#) [10014744-011ALF](#) [10014744-](#)  
[011LF](#) [10057542-1211FLF](#) [10067972-000LF](#) [10067972-050LF](#) [10122302-20110LF](#) [G85D1162022HHR](#) [MUP-C7809-1](#) [NANO SIM 7P](#)  
[H1.37](#) [MICRO SIM 7P H1.35](#) [TF-CARD H1.8 SY](#) [MICRO SIM 6P H1.35](#) [TF-CARD H1.8](#) [TF-115Y-BCP9](#) [TF-115YY-ACP9](#) [SMN-309-](#)  
[ARP6](#) [TF-115Y-ACP9](#) [TF-108-ARP10](#) [SMN-303S-ACP7](#) [SNO-14100](#) [SD-112S](#) [MUP-C7804-1](#) [KH-TF-07DT](#)