

## APPROVAL SPECIFICATIONS

Title. TACT SWITCH

Product Model. **TS-1009B**

Customer's Part NO. \_\_\_\_\_

Customer's Model: \_\_\_\_\_

### **Customer's Approval Requested.**

Please return this copy as a certification of your approval.

Checked by: \_\_\_\_\_ Date: \_\_\_\_\_

Approved by: \_\_\_\_\_ Date: \_\_\_\_\_

APPROVE	REVIEW	POLT
王凱	李成功	許志明

CUSTOMER	CUSTOMER'S P/N	GYE'S P/N	PRODUCT	REVISION
		TS-1009B	TACT SWITCH	

产品符合ROHS

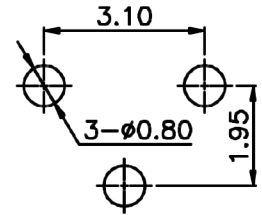
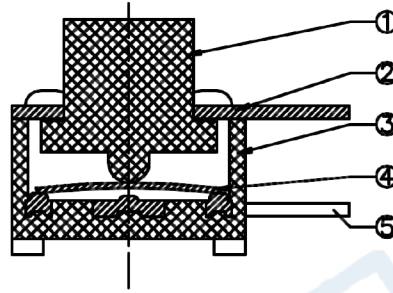
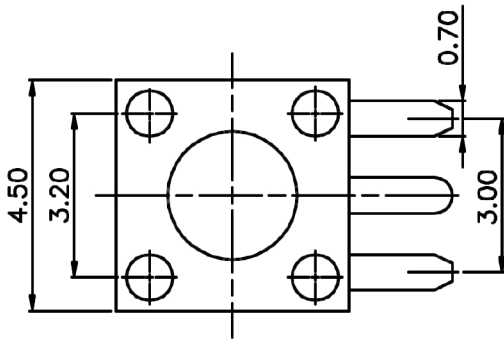

PCB Layout(Pattern Side)

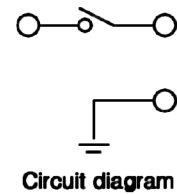
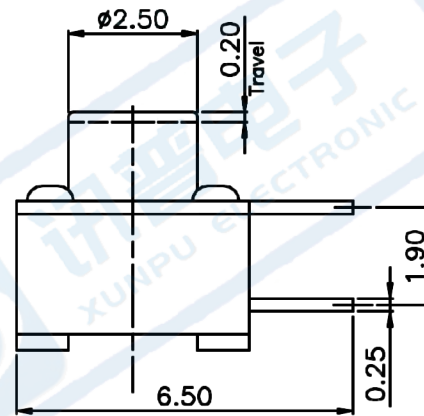
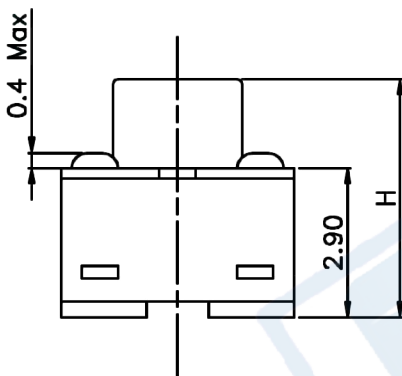

Circuit diagram

General tolerance:  $\pm 0.2\text{mm}$

NO.	NAME	MATERIAL	NATIONALITY	QTY.	FINISHING
1	Terminal	Brass (0.3t)		3	Plating silver
2	Contact	F.ag/SGS		1	
3	Base	PA46		1	Black
4	Cover	Brass		1	Plating silver
5	Keystoke	PA46		1	Black

APPROVE BY	王凱 12.05.21	CHECKED BY	李成功 12.05.21	PRPARE BY	許志明 12.05.21
------------	-------------	------------	--------------	-----------	--------------

CUSTOMER	CUSTOMER'S P/N	GYE'S P/N	PRODUCT	REVISION
		TS-1009B	TACT SWITCH	

### A. Specification & meanings

The name of the tact switch is composed by type and specification, the particular meaning of the type、specification and code is as follows.

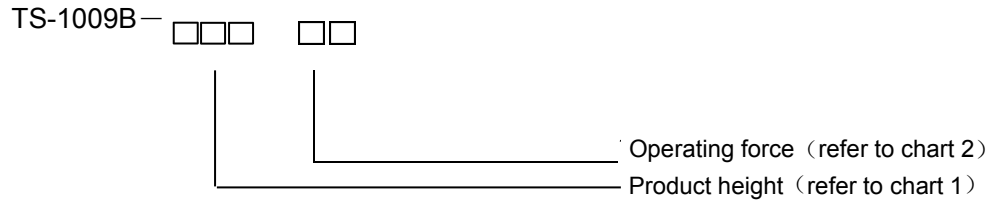

#### 1、 Product height: It is denoted by three figures:

Code	Product height(mm)	Code	Product height(mm)	Code	Product height(mm)
038	3.8	085	8.5		
043	4.3	090	9.0		
045	4.5	095	9.5		
050	5.0				
055	5.5				
060	6.0				
065	6.5				
070	7.0				
075	7.5				
080	8.0				

#### 2、 Operating force: An English letter expresses it, unite: Newton (N),as chart 2 shows:

force Code	Operating		Press force(N)	Return force
	Spec			
16	1.6		1.6±0.5	0.4min
26	2.6		2.6±0.5	0.4min

Examples: "TS-1009B-03816" denotes the tact switch with 4.5×4.5 base, the height is 3.8mm, the stem is black, the operating force is 1.6N.

APPROVE BY	王凱 12.05.21	CHECKED BY	李成功 12.05.21	PRPARE BY	許志明 12.05.21
------------	-------------	------------	--------------	-----------	--------------

CUSTOMER	CUSTOMER'S P/N	GYE'S P/N	PRODUCT	REVISION
		TS-1009B	TACT SWITCH	

- 1、概述  
**GENERAL**
- 1.2 适用范围  
**APPLICATION**  
此规格书适用于机械式轻触开关的相关要求  
This specification is applied to the requirements for TACTILE SWITCH (MECHANICAL CONTACT)
- 1.3 工作温度范围  
**Operating Temperature Range**  
-20℃~70℃(在标准大气压、标准湿度条件下)  
-20℃~70℃ (Normal humidity, normal air pressure)
- 1.4 贮藏温度范围  
**Storage Temperature Range**  
-30℃~80℃(在标准大气压、标准湿度条件下)  
-30℃~80℃ (Normal humidity, normal air pressure)
- 1.5 测试条件  
**Test Conditions**  
在没有其它特定的条件下，应该在以下的条件下进行测试和测量：  
Unless otherwise specified, tests and measurement shall be made in the following standard conditions:  
 常温.....5℃~35℃  
 Normal temperature.....5℃~35℃  
 标准湿度.....相对湿度 25%~85%  
 Normal humidity.....relative humidity 25%~85%  
 标准大气压.....86KPa~106Kpa  
 Normal air pressure.....86Kpa~106Kpa  
 在制造过程中，测试和测量应该在以下的条件下进行：  
  
 If any doubt arise from the judgment, tests shall be conducted at the following conditions:  
 温度.....20℃±2℃  
 Temperature.....20℃±2℃  
 相对湿度.....65%±5%  
 Relative humidity.....65%±5%  
 环境气压.....86KPa~106Kpa  
 Airpressure.....86KPa~106Kpa

APPROVE BY	王凱 12.05.21	CHECKED BY	李成功 12.05.21	PRPARE BY	許志明 12.05.21
------------	-------------	------------	--------------	-----------	--------------

CUSTOMER	CUSTOMER'S P/N	GYE'S P/N	PRODUCT	REVISION
		TS-1009B		

## 2、 详细说明

### Detailed specification

2.1 外观：应无影响、降低产品性能的缺陷；

Appearance: There should be no defects that affect the serviceability of product.

2.2 结构尺寸和安装尺寸：应符合装配图要求；

Style and dimension: shall conform to the assemble drawings.

2.3 操作形式：有触觉反应的操作

Type of actuating: Tactile feedback.

2.4 开关结构：单回路单输出(具体的触点结构在装配图中已绘出)；

Contact arrangement: 1 pole, 1 throw

(Details of contact arrangement are given in the assembly drawings.)

2.5 开关工作额定值：DC 12V，50mA（有效值）

Ratings: 12V DC, 50mA (effective value)

3. 电气性能：

### ELECTRICAL SPECIFICATION

项 目 ITEM		试 验 条 件 TEST CONDITIONS	要 求 REQUIREMENTS		
1	接触电阻 Contact Resistance	在以 5V 10mA 的直流电源或不低于1KHz 的交流电源的电路中，以一个等于 2 倍按力的静负荷施加于手柄中心 Applying a static load of 2 times operating force to the center of the stem, measurements shall be made by 5V DC 10mA or more than 1KHZ AC small-current contact resistance meter.	$\leq 100m\Omega$		
2	绝缘电阻 Insulation Resistance	在端子之间施加 DC 100V /1min 的条件下，测量端子之间底座、盖板的电阻值 Measurement shall be made following application of 100V DC potential, across terminals, and across terminals and cover, for one minute.	$\geq 100M\Omega$		
3	介质耐压 Dielectric voltage proof	在端子之间施加 250V AC(50HZ 或 60HZ)/1min 250V AC (50HZ or 60HZ) shall be applied across terminals, for one minute.	无击穿、无飞弧 There should be no breakdown and flashover		
APPROVE BY	王凯 12.05.21	CHECKED BY	李成功 12.05.21	PRPARE BY	許志明 12.05.21

CUSTOMER	CUSTOMER'S P/N	GYE'S P/N	PRODUCT	REVISION
		TS-1009B	TACT SWITCH	
项目 ITEM	试验条件 TEST CONDITIONS			要求 REQUIREMENTS
<b>4. 机械性能: MECHANICAL SPECIFICATION</b>				
1	按力 Operating Force	开关垂直于操作方向放置，在开关驱动件顶端中心逐渐施力，测量开关导通所需的最大力度。 Placing the switch such that the direction of switch operation is vertical and then gradually increasing the load applied to the center of the stem, the maximum load required for the switch to come to a stop shall be measured.		refer to chart 3
2	最大行程 Full Travel	开关垂直于操作方向放置，以一个等于 2 倍按力的静负荷施加在开关驱动件顶端中心，测量顶端移动的距离。 Placing the switch such that the direction of switch operation is vertical and then applying static load of 2times operating force to the center of the stem; the travel distance for the switch to come to a stop shall be measured.		0.25±0.1mm
APPROVE BY	王凱 12.05.21	CHECKED BY	李成功 12.05.21	PRPARE BY 許志明 12.05.21

CUSTOMER		CUSTOMER'S P/N	GYE'S P/N	PRODUCT	REVISION
			TS-1009B	TACT SWITCH	
项目 ITEM		试验条件 TEST CONDITIONS			要求 REQUIREMENTS
3	回弹力 Return Force	开关垂直于操作方向放置，在开关驱动件顶端中心下降至全行程后，测量顶端向自由位置转换的力度。 The sample switch is installed such that the direction of switch operation is vertical and upon depressing the stem in its center to the whole travel distance, the force of the stem to return to its free position shall be measured.			refer to chart 3
4	停止强度 Stop Strength	开关垂直于操作方向放置，从操作方向向驱动件施加 30N 的静负荷持续 1min。 Placing the switch such that the direction of switch operation is vertical, and then a static load of 30N shall be applied in the direction of stem operation for a period of 1 min.			无机械和电气损坏 There shall be no sign of damage mechanically and electrically.
5	手柄拔出强度 Stem Strength	开关垂直于操作方向放置，反方向实施最大操作力，并测量手柄的行程范围。 Placing the switch such that the direction of switch operation is vertical, and then the maximum force to withstand a pull applied opposite to the direction of stem operation shall be measured.			20N.min.
6	可焊性 Solderability	在以下设定条件下进行测量： Measurements shall be made following the test set forth below: (1) 焊接温度:245±5℃ Solder temperature : 245±5℃ (2) 浸入时间:2s±0.5s Immersion time: 2s±0.5s 对于其它步骤参考《GB 5095.6—86》试验 12a The other steps please refer to 《GB 5095.6-86》TEST 12a			除边缘外涂层应均匀覆盖 90%以上 Except for the edge, the coating should cover a minimum 90%
APPROVE BY	王凯 12.05.21	CHECKED BY	李成功 12.05.21	PRPARE BY	許志明 12.05.21

CUSTOMER	CUSTOMER'S P/N	GYE'S P/N	PRODUCT	REVISION												
		TS-1009B	TACT SWITCH													
项目 ITEM	试验条件 TEST CONDITIONS			要求 REQUIREMENTS												
5、极限电气性能： ENVIRONMENTAL SPECIFICATION																
1	低温测试 Resistance to low temperature	样品应按照以下实验条件进行测试，实验后样品应放在常温及标准湿度的环境中 1 小时后做性能测试： Following the test set forth below the sample shall be left in normal temperature and humidity conditions for 1 h before measurements are made: (1) 温度：-30±2℃ Temperature : -30±2℃ (2) 时间：96h Time: 96h		接触电阻：≤200mΩ Contact resistance: ≤200mΩ 项目 3,4.1,4.2,4.3 Item 3,4.1,4.2,4.3												
2	高温测试 Heat resistance	样品应按照以下实验条件进行测试，实验后样品应放在常温及标准湿度的环境中 1 小时后做性能测试： Following the test set forth below the sample shall be left in normal temperature and humidity conditions for 1 h before measurements are made: (1) 温度：80±2℃ temperature:80±2℃ (2) 时间：96h time: 96h		接触电阻：≤200mΩ Contact resistance: ≤200mΩ 项目 3,4.1,4.2,4.3 Item 3,4.1,4.2,4.3												
3	温度周期性测试 Change of temperature	根据下面的测试要求进行 5 次循环的温度周期性测试，实验后样品应放在常温及标准湿度的环境中 1 小时后做性能测试。测试期间样品应保持干燥。 After 5 cycles of following conditions, the sample shall be allowed to stand under normal temperature and humidity conditions for 1 h. and measurements shall be made. During the test water drops shall be removed. <table border="1" style="margin: 10px auto; border-collapse: collapse;"> <thead> <tr> <th></th> <th style="text-align: center;">Temperature</th> <th style="text-align: center;">Time</th> </tr> </thead> <tbody> <tr> <td rowspan="4" style="text-align: center; vertical-align: middle;">1cycle</td> <td style="text-align: center;">-10±2℃</td> <td style="text-align: center;">2(hour)</td> </tr> <tr> <td style="text-align: center;">-10~65℃</td> <td style="text-align: center;">1</td> </tr> <tr> <td style="text-align: center;">65±2℃</td> <td style="text-align: center;">2</td> </tr> <tr> <td style="text-align: center;">65~-10℃</td> <td style="text-align: center;">1</td> </tr> </tbody> </table>			Temperature	Time	1cycle	-10±2℃	2(hour)	-10~65℃	1	65±2℃	2	65~-10℃	1	接触电阻：≤200mΩ Contact resistance: ≤200mΩ 项目 3,4.1,4.2,4.3 Item 3,4.1,4.2,4.3
	Temperature	Time														
1cycle	-10±2℃	2(hour)														
	-10~65℃	1														
	65±2℃	2														
	65~-10℃	1														
APPROVE BY	王凱 12.05.21	CHECKED BY	李成功 12.05.21	PRPARE BY 許志明 12.05.21												



CUSTOMER	CUSTOMER'S P/N	GYE'S P/N	PRODUCT	REVISION
		TS-1009B	TACT SWITCH	
项目 ITEM	试验条件 TEST CONDITIONS			要求 REQUIREMENTS
4	湿温测试 Moisture resistance	样品应按照以下实验条件进行测试，实验后样品应放在常温及标准湿度的环境中 1 小时后做性能测试：Following the test set forth below the sample shall be left in normal temperature and humidity conditions for 1 h before measurements are made: (1) 温度：60±2℃ temperature: 60±2℃ (2) 相对湿度：90%~95% relative humidity:90% to 95% (3) 时间：96h time: 96h		接触电阻：≤200mΩ Contact resistance: ≤200mΩ 项目 3,4.1,4.2,4.3 Item 3,4.1,4.2,4.3
5	硫化试验 Sulfuration resistance	样品应按照以下实验条件进行测试，实验后样品应放在常温及标准湿度的环境中 1 小时后做性能测试：Following the test set forth below the sample shall be left in normal temperature and humidity conditions for 1 h before measurements are made: (1) H <sub>2</sub> S 气体浓度：3ppm±1ppm H <sub>2</sub> S gas concentration: 3ppm±1ppm (2) 时间：72h Time: 72h (3) 温度：40±2℃ (90~95%RH) temperature: 40±2℃ (90~95%RH)		接触电阻：≤200mΩ Contact resistance: ≤200mΩ 项目 3,4.1,4.2,4.3 Item 3,4.1,4.2,4.3
6	盐雾试验 Salt Mist	在以下设定条件下进行测量： The switch shall be checked after following test: (1) 温度：35℃±2℃ temperature: 35℃±2℃ (2) 盐溶液浓度：5±1% (质量百分比) salt solution : 5±1%(solids by mass) (3) 时间：8h±1h Time: 8h±1 hour 实验后的盐沉积物后水冲掉 After test, salt deposit shall be removed by running water.		金属件上没有腐蚀斑点 No remarkable corrosion shall be recognized in metal part.
APPROVE BY	王凯 12.05.21	CHECKED BY	李成功 12.05.21	PRPARE BY 許志明 12.05.21

CUSTOMER	CUSTOMER'S P/N	GYE'S P/N	PRODUCT	REVISION
		TS-1009B	TACT SWITCH	

**6. 极限机械性能:**
**ENDURANCE SPECIFICATION**

项目 ITEM	试验条件 TEST CONDITIONS	要求 REQUIREMENTS						
1 工作寿命 Operation life	根据下面的测试要求进行测试: Measurement shall be made following the test set forth below: (1) DC 12V, 50mA 带负载 DC 12V, 50 mA resistive load (2) 按动速率: 1 次/秒 Rate of operation: 1times/s (3) 按力: 按力的 1.5 倍 Operating Force: Operating Force1.5double (4) 平均无故障寿命: Average fault-free life <table border="1" style="margin-left: 40px;"> <tr> <td>16</td> <td>1.6</td> <td>100000 次</td> </tr> <tr> <td>25</td> <td>2.5</td> <td>100000 次</td> </tr> </table>	16	1.6	100000 次	25	2.5	100000 次	接触电阻 $\leq 200\text{m}\Omega$ Contact resistance $\leq 200\text{m}\Omega$ 触点弹力 $\leq 10\text{ms}$ Contact bounce $\leq 10\text{ms}$ 按力: 初值的 $\pm 30\%$ Operating Force: initial value $\pm 30\%$ 项目 3,4.1,4.2,4.3 Item 3,4.1,4.2,4.3
16	1.6	100000 次						
25	2.5	100000 次						
2 振动Vibration	根据以下给定条件进行测试: Measurement shall be made following the test set forth below: (1) 振动频率范围: 10~55~10Hz Vibration frequency range: 10 to 55 to 10Hz (2) 振幅 (峰-峰): 1.5mm Amplitude: 1.5mm ③ 振动方向: 包括手柄行程方向在内的三个相互垂直的方向 Direction of vibration: Three mutually perpendicular direction including the direction of stem travel ④ 测试时间: 每次 2hours . Duration: Each 2hours.	项目 3,4.1,4.2,4.3 Item 3,4.1,4.2,4.3						

**7. 焊接条件:**
**SOLDERING CONDITIONS:**

7.1 手工焊接 Hand soldering	请按以下条件进行焊接: (1) 焊锡温度: $\leq 350^\circ\text{C}$ (2) 连续焊接时间: $\leq 3\text{ s}$  Please practice according to below conditions: (1) Soldering temperature: $350^\circ\text{C Max.}$ (2) Continuous soldering time: 3 s Max.
-------------------------------	--

APPROVE BY	王凱 12.05.21	CHECKED BY	李成功 12.05.21	PRPARE BY	許志明 12.05.21
------------	-------------	------------	--------------	-----------	--------------

CUSTOMER		CUSTOMER'S P/N	GYE'S P/N	PRODUCT	REVISION
			TS-1009B	TACT SWITCH	
7.2	自动浸焊 Conditions for Auto-dip	项目 Items	条件 Condition		
		助焊剂附着量 Flux built-up	不附着于零部件贴装面的程度 Mounting surface should not be coated with flux		
		预热温度 Preheating temperature	印刷电路板焊接面的周围温度 100℃ max. Ambient temperature of the soldered surface of PC board. 100℃ max.		
		预热温度时间 Preheating time	60s max.		
		焊接温度 Soldering temperature	260℃ max.		
		焊接浸渍时间 Continuous dipping time	5s max.		
		焊接次数 Number of soldering	2 次以下 2times max.		
<p><b>焊接说明:</b></p> <p>1、开关浸焊后，注意不要用溶剂清洗。 After switches were soldered, please be careful not to clean switches with solvent.</p> <p>1.1 在使用烙铁的情况下，焊锡温度应在 350℃ 以下、3 秒以内。 In the case of using soldering iron, soldering conditions shall be 350℃ max and 3 sec. max.</p> <p>1.2 浸焊后，注意不要在顶部施加负荷。 Right after switches were soldered; please be careful not to load to on the knobs of switches.</p> <p><b>2、设计中应注意的事项( Design instructions)</b></p> <p>2.1 印刷基板的安装孔尺寸参见产品图。 Follow recommended P.W.B. piercing plan in outside drawing page.</p> <p><b>3、注意点(Note):</b></p> <p>3.1 注意不要施加超负荷的压力或晃动开关。 Please be cautions not to give excessive static load or shock to swiches.</p> <p>3.2 开关浸焊后，印刷基板注意不要叠放。 Please be careful not to pile up P.W.B. after switches were soldered.</p> <p>3.3 保管时尤其应注意避开高湿高温和有腐蚀性气体的环境。如需要长时间保存，请不要打开包装箱。 Preservation under high temperature and high high humidity or corrosive gas should be avoided Especially . When you need to preserve for a long period ,do not open the carton.</p>					
APPROVE BY	王凯 12.05.21	CHECKED BY	李成功 12.05.21	PRPARE BY	許志明 12.05.21

## X-ON Electronics

Largest Supplier of Electrical and Electronic Components

*Click to view similar products for [Tactile Switches](#) category:*

*Click to view products by [XUNPU](#) manufacturer:*

Other Similar products are found below :

[KMR633NG LFG](#) [5GTH92001](#) [5GTH9202242](#) [6426-201-11343](#) [MJ1226](#) [MJTP1109B](#) [MJTP1138EAUTR](#) [MJTP1230BL](#) [MJTPSHW](#)  
[GS6.90F300QP](#) [1-1977223-0](#) [1-1977120-4](#) [ADTSA62NV](#) [ADTSA62RV](#) [ADTSA63KV](#) [ADTSA644NV](#) [ADTSM24NVTR](#) [ADTSMW66NV](#)  
[ADTSMW67RV](#) [ATM533VTR](#) [1571300-3](#) [B3F-3123](#) [B3F-6055A](#) [B3F-B32-01-KIT](#) [1977177-8](#) [1977266-1](#) [2-1977223-4](#) [2-1977223-7](#)  
[ADTS644KV](#) [ADTSA61RV](#) [ADTSA62KV](#) [ADTSA63NV](#) [ADTSA63RV](#) [ADTSA65NV](#) [ADTSM21NSVTR](#) [ADTSM25RVTR](#)  
[ADTSM31RVTR](#) [ADTSM32NVTR](#) [ADTSM61YVTR](#) [ADTSM63SVTR](#) [ADTSM644KVTR](#) [ADTSMW64RV](#) [ADTSMW69NV](#)  
[FSMRA4JHA04](#) [GS4.70F300QP](#) [D38999/20JJ37SA](#) [TL1105B](#) [TL1105J](#) [ATH447K2Q](#) [ATM534VTR](#)