



TS-1104
W3.00xD2.10xH

按压力度(Press pressure) : 1.0N/1.6N/2.5N

开关行程(Switch stroke) : 0.13±0.05mm

操作方式(Operation mode): 正按式/Positive press

操作寿命(Operation life): 300,000 Cycles Min

储存温度(Storage temperature): -30°C TO +80°C

焊接温度(Welding temperature): 260±5° 5s

额定负荷(Rated load): DC 12V 50mA

焊接方式(Welding mode): 贴片式/SMT

接触电阻(Contact resistance): 500mΩ max.

包装方式(Packaging method): 卷带/Tape & Reel (TR)

绝缘电阻(Insulation resistance): 100MΩ min.

最小包装(Minimum packing): 10,000/PCS

外形尺寸 (UNIT:MM) / Size Chart

www.xunpudianzi.com

更多资料请参考技术选型档!

IP67

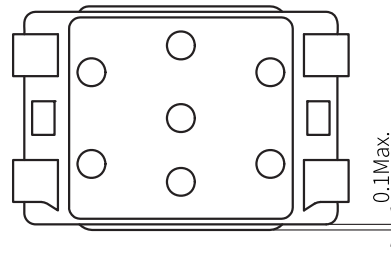
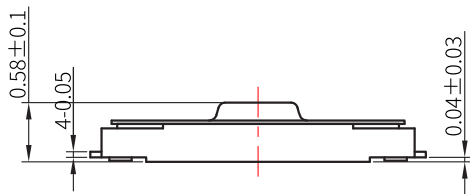
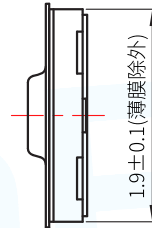
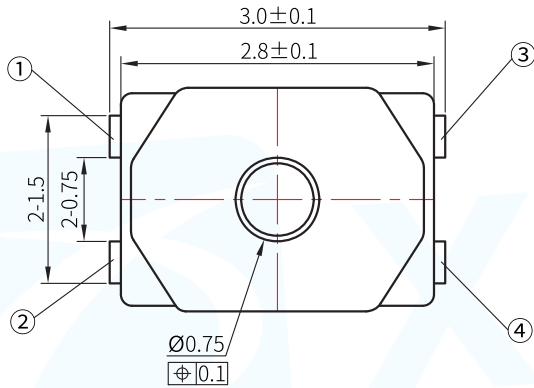

产品编号/Product No

TS-1104-X X XXX XX

A: 不锈钢(SUS) Operating force
B: 覆银铜(C5210)
C: 带柱(Column) Product height
R: 不带柱(No Column)

产品高度/Product Height

Code	Product height(mm)
0060	0.60

材质/Material

NO	NAME	MATERIAL	FINISHING
1	TERMINAL	PHOSPHOR BRONZE	Ag-PLATED
2	HOUSING	POLYAMIDE	BLACK
3	DOME	SUS301	Ag-PLATED
4	FILM	POLYAMIDE	WHITE
5	KNOB	POLYAMIDE	BLACK

操作力度/Operating Force

Code	Press force(N)	Return force
16	1.6±0.5	0.4min
26	2.6±0.5	0.4min

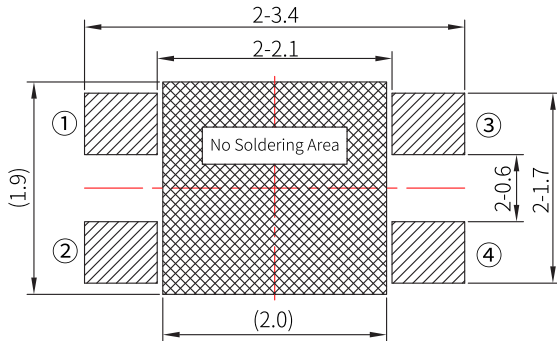

RECOMMENDED P.C.B LAYOUT
安装尺寸图

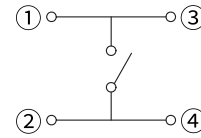

CIRCUIT DIAGRAM
回路图

焊接条件 / Welding conditions

● 回流焊/Reflow soldering

适用表面贴装型产品/Applicable to surface mount products
温度分布/Temperature distribution

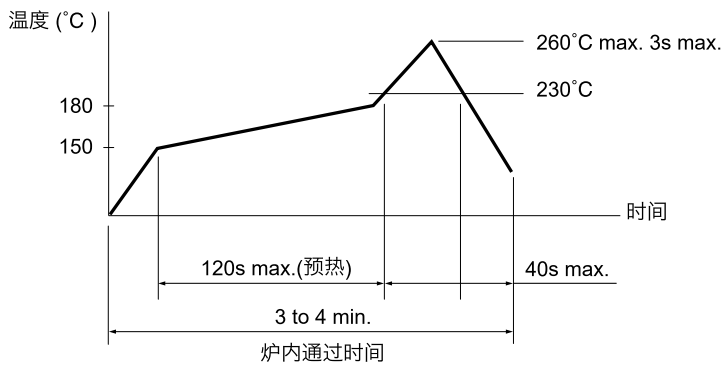

● 手焊式/Hand welding

项目/Project	条件/condition
焊接温度 Welding temperature	350°C max.
持续焊接时间 Continuous welding time	3s max.
焊剂斗容量 Flux bucket capacity	60W max.

● 浸焊式/Immersion soldering

项目/Project	条件/condition
助焊剂附着量 Flux adhesion	不附着于零部件贴装面的程度 Not attached to the mounting surface of components
预热温度 Preheating temperature	印刷电路板焊接面的周围温度 100°C max. The temperature around the welding surface of PCB is 100 °C max
预热温度时间 Preheat temperature time	60s max.
焊接温度 welding temperature	260°C max.
焊接浸渍时间 Welding immersion time	5s max.
焊接次数 Welding times	2 times max.

注:

1. 加热方式:以远红外线上下加热方式。
2. 温度测量:用Φ0.1~0.2 的 CA(K)或 CC(T)测量位置在焊接连接部(锡/铜箔面)。
3. 固定方式:采用耐热胶带。

X-ON Electronics

Largest Supplier of Electrical and Electronic Components

Click to view similar products for [Tactile Switches](#) category:

Click to view products by [XUNPU](#) manufacturer:

Other Similar products are found below :

[KMR633NG LFG](#) [5GTH92001](#) [5GTH9202242](#) [6426-201-11343](#) [MJ1226](#) [MJTP1109B](#) [MJTP1138EAUTR](#) [MJTP1230BL](#) [MJTPSHW](#)
[GS6.90F300QP](#) [1-1977223-0](#) [1-1977120-4](#) [ADTSA62NV](#) [ADTSA62RV](#) [ADTSA63KV](#) [ADTSA644NV](#) [ADTSM24NVTR](#) [ADTSMW66NV](#)
[ADTSMW67RV](#) [ATM533VTR](#) [1571300-3](#) [B3F-3123](#) [B3F-6055A](#) [B3F-B32-01-KIT](#) [1977177-8](#) [1977266-1](#) [2-1977223-4](#) [2-1977223-7](#)
[ADTS644KV](#) [ADTSA61RV](#) [ADTSA62KV](#) [ADTSA63NV](#) [ADTSA63RV](#) [ADTSA65NV](#) [ADTSM21NSVTR](#) [ADTSM25RVTR](#)
[ADTSM31RVTR](#) [ADTSM32NVTR](#) [ADTSM61YVTR](#) [ADTSM63SVTR](#) [ADTSM644KVTR](#) [ADTSMW64RV](#) [ADTSMW69NV](#)
[FSMRA4JHA04](#) [GS4.70F300QP](#) [D38999/20JJ37SA](#) [TL1105B](#) [TL1105J](#) [ATH447K2Q](#) [ATM534VTR](#)