

IPX7

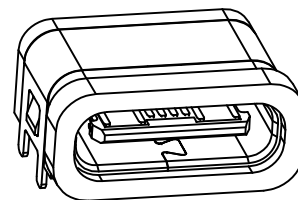
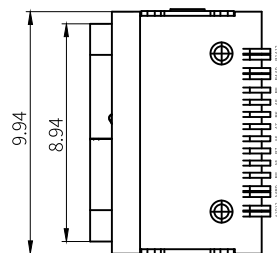
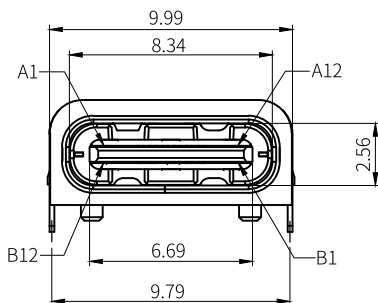

PIN	SIGNAL NAME	PIN	SIGNAL NAME
A1	GND	B12	GND
A4	VBUS	B9	VBUS
A5	CC1	B8	SBU2
A6	DP1	B7	DN2
A7	DN1	B6	DP2
A8	SBU1	B5	CC2
A9	VBUS	B4	VBUS
A12	GND	B1	GND

SPECIFICATION:

- 1.CURRENT RATING: 3.0A MAX
- 2.VOLTAGE: 100 VAC
- 3.TEMPERATURE RANGE: -30°C ~ +85°C
- 4.CONTACT RESISTANCE: 40 MILLIONHM MAX
- 5.INSULATION RESISTANCE: 100 MEGOHMS MIN
- 6.INSERTION FORCE: 5N ~ 20N
- 7.UNMATING FORCE: 8N ~ 20N
- 8.DURABILITY: 10,000 CYCLES
- 9.WATER PROOFNESS: THIS PRODUCT IS BASED ON IPX7.

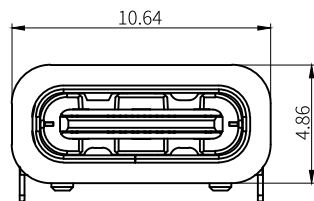
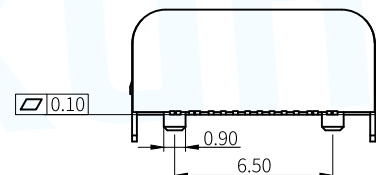
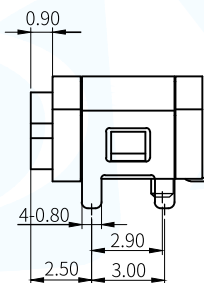
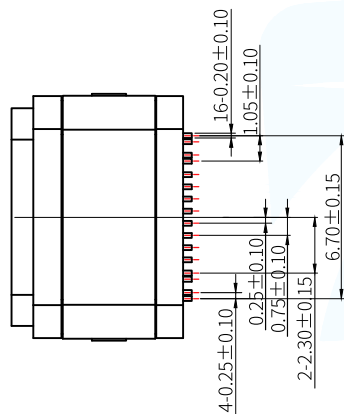

带防水圈示意图

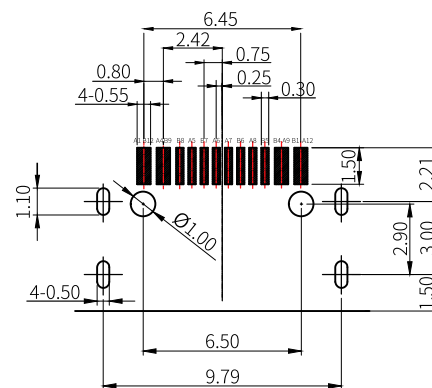
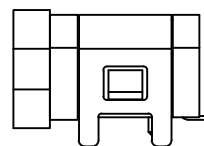

RECOMMENDED P.C.B. LAYOUT
TOLERANCE UNSPECIFIED ±0.05mm

ITEM	Description	Qty	Material	Remarks
1	HOUSING	1PCS	HIGH TEMPERATURE PLASTIC	BLACK
2	SHELL HOUSING	1PCS	HIGH TEMPERATURE PLASTIC	BLACK
3	CONTACT	1SET	COPPER ALLOY	TIN/Au/NI Plated
4	SHIELDING PLATE	1PCS	STAINLESS STEEL	NI Plated
5	SHELL	1PCS	STAINLESS STEEL	NI Plated
6	防水圈	1PCS	硅胶	BLACK

MANUFACTURE DWG		东莞市讯普电子科技有限公司 DongGuan XunPu Electronics Co.,Ltd	
UNLESS OTHERWISE SPECIFIED TOLERANCES		TITLE: Type.c单排6PIN四脚插板防水母座 PAR TYPEC-301-ACP16X7 DWN KING 2016.06.18 CHKD APVD SCALE 1:1 UNIT: mm SIZE:A4 SHEET:1F1 REV:A	
DECIMALS:	ANGLES:		
X:±0.5	X:±2°		
X.X:±0.3	X.X:±1°		
X.XX:±0.2		CUSTOMER COPY	

X-ON Electronics

Largest Supplier of Electrical and Electronic Components

Click to view similar products for [USB Connectors](#) category:

Click to view products by [XUNPU](#) manufacturer:

Other Similar products are found below :

[10033527-N3112MLF](#) [17-210561](#) [GMCB05B11124H1EU](#) [17-200931](#) [65-647-8-BK-BU](#) [690-010-295-484](#) [73725-1191BLF](#) [950](#) [E8144-B01021-L](#) [A-USB A-LP-SMT-C](#) [A-USB B-TOP-C](#) [MUSBA511N5](#) [MUSBB15131](#) [MUSBC111M5](#) [MUSBD11135](#) [217450-1](#) [CA 6 W LD](#) [896-30-004-00-000000](#) [KUSBVX-BS1N-W30](#) [KUSBX-AP-KIT-SCBLK](#) [KUSBX-AS2N-W](#) [KUSBX-SMT2AP1S-W](#) [KUSBX-SMTAS1NBTR](#) [KUSBX-SMTBS1NBTR](#) [30-498-6](#) [SK-60A-2](#) [17-200261](#) [17-210051](#) [1734082-1](#) [FK-37-32SL](#) [30-1574](#) [30-470](#) [30-489](#) [30-541](#) [30-572-3](#) [30-9503](#) [M9177/2-1](#) [MAB 5 S](#) [MIKROE-1451](#) [33UBBR-04SW11R](#) [USBFTV2PEM2G](#) [USBFTVC6ZN](#) [USBFTVSCCG](#) [KUSBX-AS2N-W30](#) [KUSBX-SLAS1N-W](#) [KUSBX-SLAS1N-W30](#) [1-1734084-2](#) [E8110-001-01](#) [MUSBC11135](#) [NK-27-32SL](#)