



USB-256-BRWH130
W13.00xD13.10xH5.70

PIN数(Number of contacts) : 4PIN

插座类型(Socket type) : 2.0 USB

插座类别(Socket category): 母座/Mother seat

操作方式(Operation mode): 立式/Vertical

温度范围(Operating temp): -20°C TO +70°C

操作寿命(Operation life): 5,000 Cycles Min

额定负荷(Rated load): DC 30V 1.5A

焊接方式(Welding mode): 插件式/DIP

接触电阻(Contact resistance): $\leq 50m\Omega$

包装方式(Packaging method): 吸塑盘/Tray

绝缘电阻(Insulation resistance): $\geq 1000M\Omega$

最小包装(Minimum packing): 1,000/PCS

外形尺寸(UNIT:MM) / Size Chart

www.xunpudianzi.com

更多资料请参考技术选型档!

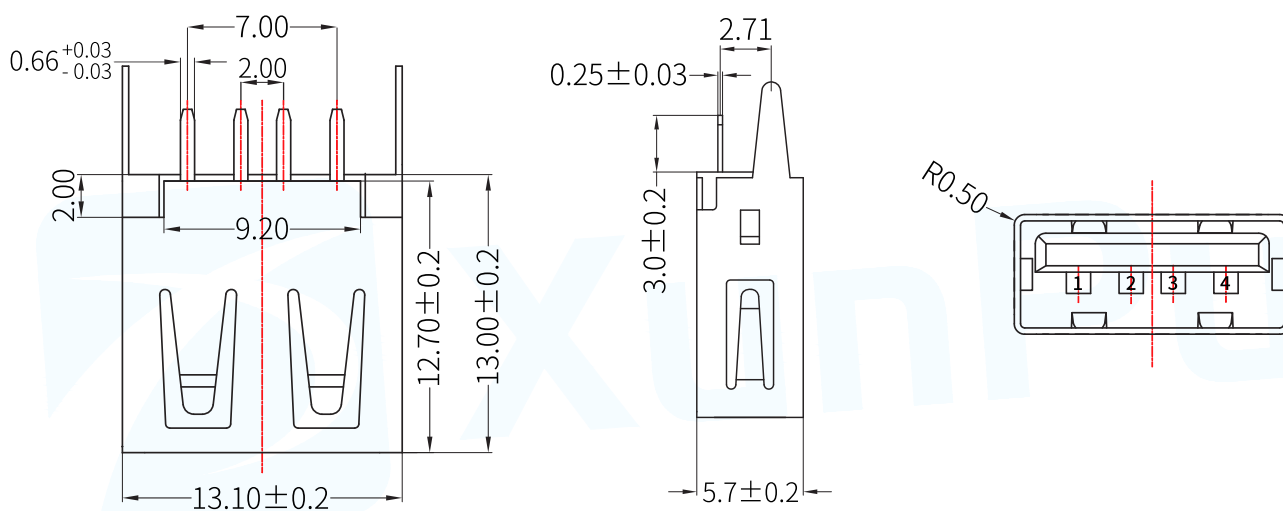

线路板安装(UNIT:MM) / Mounting Dimensions

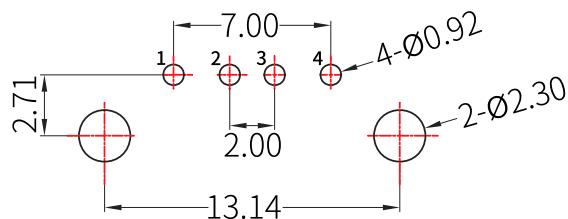

P.C.B LAYOUT(copper-side view)

引脚定义/Pin Definition

PIN	Signal Name	Describe
1	VBUS	+5V
2	D-	Negative Data Channel
3	D+	Positive Data Channel
4	GND	Ground

● 回流焊/Reflow soldering

适用表面贴装型产品/Applicable to surface mount products
温度分布/Temperature distribution

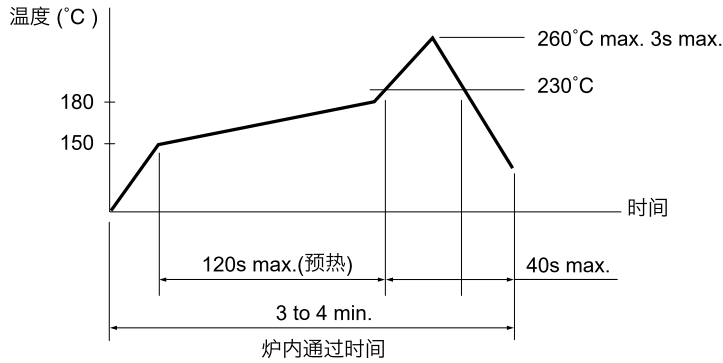

注:

1. 加热方式:以远红外线上下加热方式。
2. 温度测量:用 $\phi 0.1\sim 0.2$ 的 CA(K)或 CC(T)测量位置在焊接连接部(锡/铜箔面)。
3. 固定方式:采用耐热胶带。

● 手焊式/Hand welding

项目/Project	条件/condition
焊接温度 Welding temperature	350°C max.
持续焊接时间 Continuous welding time	3s max.
焊剂斗容量 Flux bucket capacity	60W max.

● 浸焊式/Immersion soldering

项目/Project	条件/condition
助焊剂附着量 Flux adhesion	不附着于零部件贴装面的程度 Not attached to the mounting surface of components
预热温度 Preheating temperature	印刷电路板焊接面的周围温度 100°C max. The temperature around the welding surface of PCB is 100 °C max
预热温度时间 Preheat temperature time	60s max.
焊接温度 welding temperature	260°C max.
焊接浸渍时间 Welding immersion time	5s max.
焊接次数 Welding times	2 times max.

讯普电子 — 连接器、开关制造品牌!

X-ON Electronics

Largest Supplier of Electrical and Electronic Components

Click to view similar products for [USB Connectors](#) category:

Click to view products by [XUNPU](#) manufacturer:

Other Similar products are found below :

[10033527-N3112MLF](#) [17-210561](#) [GMCB05B11124H1EU](#) [17-200931](#) [65-647-8-BK-BU](#) [690-010-295-484](#) [73725-1191BLF](#) [950](#) [E8144-B01021-L](#) [A-USB A-LP-SMT-C](#) [A-USB B-TOP-C](#) [MUSBA511N5](#) [MUSBB15131](#) [MUSBC111M5](#) [MUSBD11135](#) [217450-1](#) [CA 6 W LD](#)
[896-30-004-00-000000](#) [KUSBVX-BS1N-W30](#) [KUSBX-AP-KIT-SCBLK](#) [KUSBX-AS2N-W](#) [KUSBX-SMT2AP1S-W](#) [KUSBX-SMTAS1NBTR](#) [KUSBX-SMTBS1NBTR](#) [30-498-6](#) [SK-60A-2](#) [17-200261](#) [17-210051](#) [1734082-1](#) [FK-37-32SL](#) [30-1574](#) [30-470](#) [30-489](#) [30-541](#) [30-572-3](#) [30-9503](#) [M9177/2-1](#) [MAB 5 S](#) [MIKROE-1451](#) [33UBBR-04SW11R](#) [USBFTV2PEM2G](#) [USBFTVC6ZN](#) [USBFTVSCCG](#)
[KUSBX-AS2N-W30](#) [KUSBX-SLAS1N-W](#) [KUSBX-SLAS1N-W30](#) [1-1734084-2](#) [E8110-001-01](#) [MUSBC11135](#) [NK-27-32SL](#)