

技术要求Specification:

1. 材质Material: PA66 UL94V-0:
2. 额定电流 Current rating:2.0A AC,DC
3. 额定电压 Voltage rating:250V AC,DC
4. 温度范围 Temperature range:-25℃to+85℃
5. 接触电阻 Contact resistance:≤20mΩ
6. 绝缘电阻Insulation resistance:≥1000MΩ
7. 耐压Withstand voltage:500V AC/minute
8. 塑件表面平整光洁, 无明显的毛刺、气泡、变形、浇口拉伤、缺料等不良现象。

Plastic surface smooth and clean, no obvious glitches, bubbles, distortion, gate strain, lack of material and other undesirable phenomena.

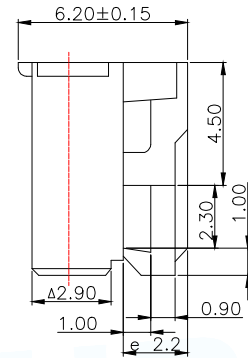
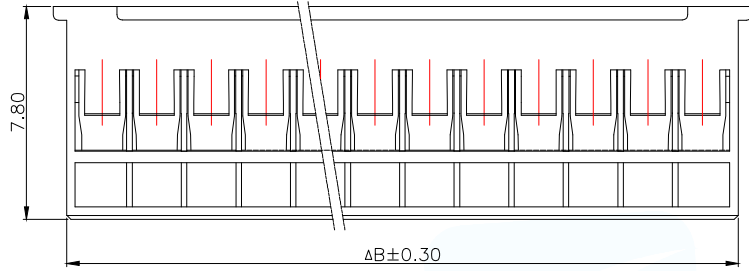
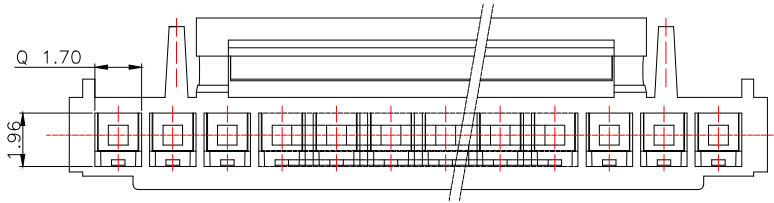

← F向

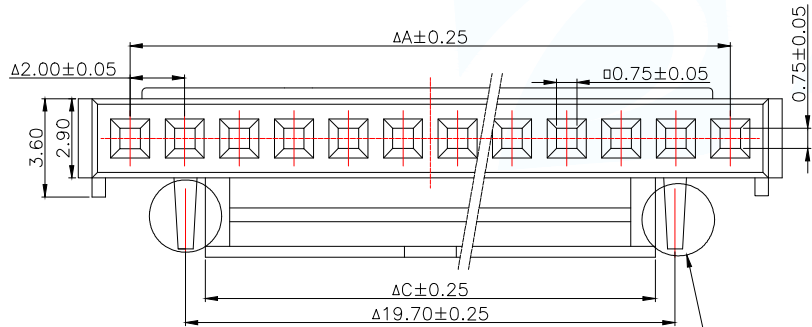

此凸点只限10PIN以上的产品有, 2-10PIN均无此凸点

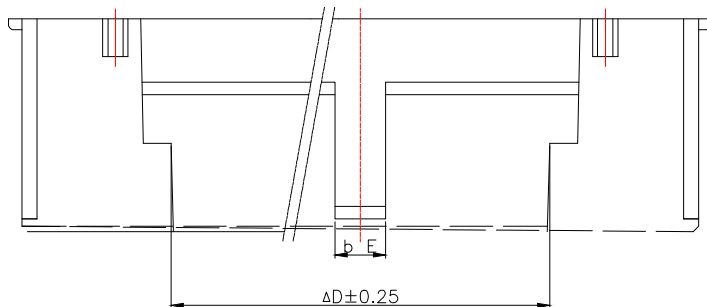
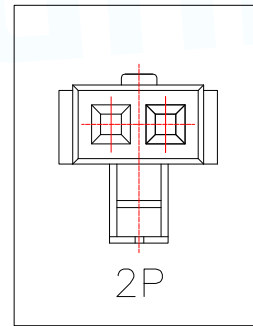

F向

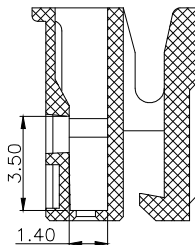

Part No	Pin	A	B	C	D	E
WAFER-HY2.0-2PJK	2	2.00	4.70	2.30	1.00	0.60
WAFER-HY2.0-3PJK	3	4.00	6.70	2.30	1.00	0.60
WAFER-HY2.0-4PJK	4	6.00	8.70	4.30	1.70	1.00
WAFER-HY2.0-5PJK	5	8.00	10.70	4.30	1.70	1.00
WAFER-HY2.0-6PJK	6	10.00	12.70	8.30	5.90	1.95
WAFER-HY2.0-7PJK	7	12.00	14.70	10.30	7.90	1.95
WAFER-HY2.0-8PJK	8	14.00	16.70	12.30	9.90	1.95
WAFER-HY2.0-9PJK	9	16.00	18.70	12.30	9.90	1.95
WAFER-HY2.0-10PJK	10	18.00	20.70	12.30	9.90	1.95
WAFER-HY2.0-11PJK	11	20.00	22.70	16.30	13.90	1.95
WAFER-HY2.0-12PJK	12	22.00	24.70	16.30	13.90	1.95
WAFER-HY2.0-13PJK	13	24.00	26.70	16.30	13.90	1.95
WAFER-HY2.0-14PJK	14	26.00	28.70	16.30	13.90	1.95
WAFER-HY2.0-15PJK	15	28.00	30.70	16.30	13.90	1.95
WAFER-HY2.0-16PJK	16	30.00	32.70	16.30	13.90	1.95

MANUFACTURE DWG		东莞市讯普电子科技有限公司 DongGuan XunPu Electronics Co.,Ltd	
UNLESS OTHERWISE SPECIFIED TOLERANCES			TITLE: HY2.0MM HOUSING
DECIMALS:	ANGLES:		PAR WAFER-HY2.0-NPJK
.X±0.30	X:±1°		DWN
.XX±0.20			CHKD
.XXX±0.10		APVD	SCALE 1:1 UNIT:MM
CUSTOMER COPY		SIZE:A4	SHEET:1F1
			REV:A

X-ON Electronics

Largest Supplier of Electrical and Electronic Components

Click to view similar products for [Headers & Wire Housings](#) category:

Click to view products by [XUNPU](#) manufacturer:

Other Similar products are found below :

[0015917161](#) [0022155065](#) [57102-F02-18ULF](#) [58102-G61-06LF](#) [582553-1](#) [01.001.5753.1](#) [0050291907](#) [02.125.8002.8](#) [609-3404](#) [61062-3](#)
[CSU011177004](#) [622-0430](#) [622-3653LF](#) [63453-116](#) [636-1030](#) [636-1427](#) [636-3427](#) [636-4007](#) [641938-9](#) [65495-038](#) [65692-001LF](#) [65781-018](#)
[65781-047](#) [65817-010LF](#) [65817-015LF](#) [67095-007LF](#) [67601157](#) [68631-112](#) [68645-018](#) [699319-000](#) [70.362.1628.0](#) [70-4210](#) [70-4226B](#) [70-](#)
[4853B](#) [71.350.2428.0](#) [733-134](#) [733-162](#) [760-3052](#) [MHR-64-VUAL](#) [80.063.4001.1](#) [800-90-001-10-001000](#) [801-43-002-10-013000](#)
[801-43-006-10-002000](#) [803-43-024-10-001000](#) [803-93-012-10-001000](#) [8-1437020-4](#) [819-22-004-30-001101](#) [820-22-006-30-001101](#)
[820-22-008-30-001101](#) [821-22-002-10-001101](#)