

MAPX	MODIFICATION	DATE	DRAW	APPROVE

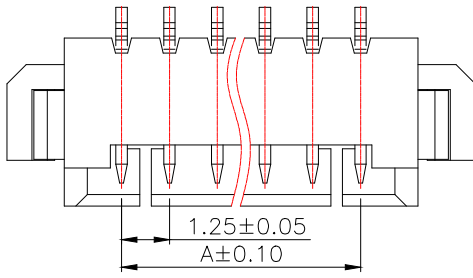

- NOTES:
1. Working temp: -25°C~85°C.
 2. Voltage rating: 100V AC/DC(rms)
 3. Contact resistance: 40mΩ max.
 4. Insulation resistance: 100MΩ min.
 5. Current rating: 1A AV/DC
 6. Withstanding Voltage: 500V AC/minute
 7. Pin Retention Force: 5N min.
 8. Housing material: LCP UL94-V0, Natural
 9. Terminal materl: Brass, plating Ni 50u" min , plating Tin 100u"min.
 10. Solder tab material: Brass, plating Ni 50u" min , plating Tin 100u"min.

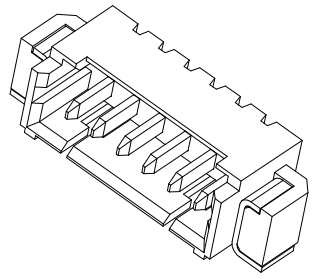
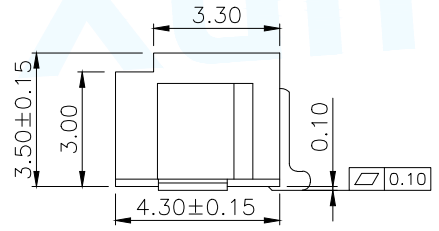
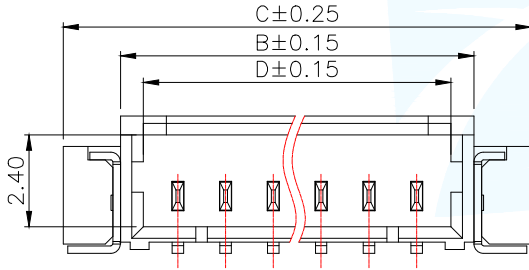

PIN	NO.	Dim A	Dim B	Dim C	Dim D
2	WAFER-MX1.25B-2PWB	1.25	4.45	7.45	3.05
3	WAFER-MX1.25B-3PWB	2.50	5.70	8.70	4.30
4	WAFER-MX1.25B-4PWB	3.75	6.95	9.95	5.55
5	WAFER-MX1.25B-5PWB	5.00	8.20	11.20	6.80
6	WAFER-MX1.25B-6PWB	6.25	9.45	12.45	8.05
7	WAFER-MX1.25B-7PWB	7.50	10.70	13.70	9.30
8	WAFER-MX1.25B-8PWB	8.75	11.95	14.95	10.55
9	WAFER-MX1.25B-9PWB	10.00	13.20	16.20	11.8
10	WAFER-MX1.25B-10PWB	11.25	14.45	17.45	13.05
11	WAFER-MX1.25B-11PWB	12.50	15.70	18.70	14.3
12	WAFER-MX1.25B-12PWB	13.75	16.95	19.95	15.55
13	WAFER-MX1.25B-13PWB	15.00	18.20	21.20	16.80
14	WAFER-MX1.25B-14PWB	16.25	19.45	22.45	18.05
15	WAFER-MX1.25B-15PWB	17.50	20.70	23.70	19.3
16	WAFER-MX1.25B-16PWB	18.75	21.95	24.95	20.55

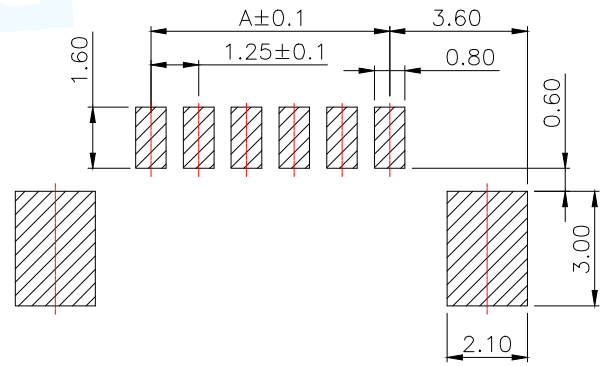
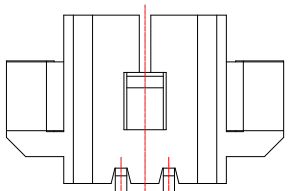
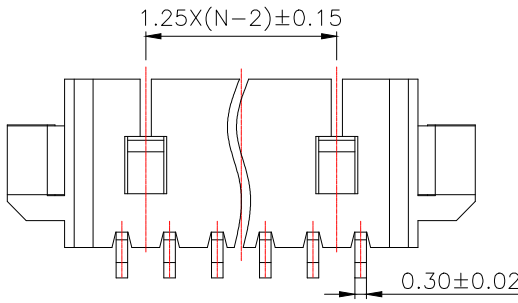

RECOMMENDED PCB LAYOUT TOP VIEW (TOLERANCE:±0.05)

SMT SOLDER AREA

MANUFACTURE DWG		东莞市讯普电子科技有限公司 DongGuan XunPu Electronics Co.,Ltd	
UNLESS OTHERWISE SPECIFIED TOLERANCES			TITLE: WAFER PH1.25mm H3.6mm W/ B 90°SMT
DECIMALS:	ANGLES:		PAR WAFER-MX1.25B-NPWB
.X:±0.35	X':±5°		DWN
.XX:±0.25	X.X':±3°		CHKD
.XXX:±0.15	X.XX':±1°	CUSTOMER COPY	APVD SCALE: 1:1 UNIT: MM SIZE: A4 SHEET: 1F1 REV: A

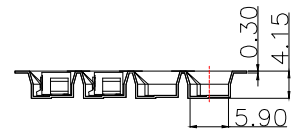
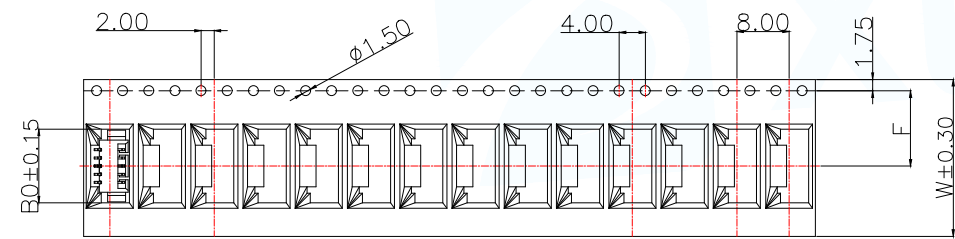
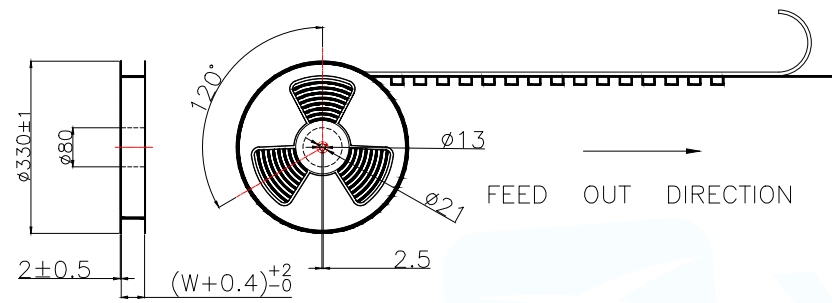
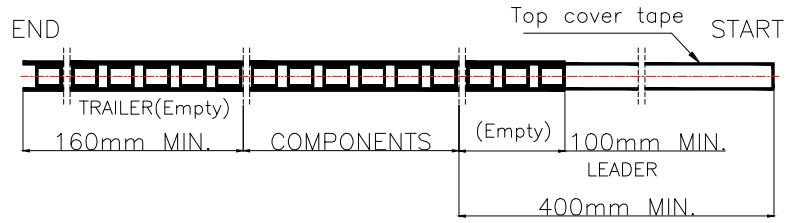

PIN	NO.	Dim B0	Dim W	Dim F	PCS/RELL	RELL/CARTON	PCS/CARTON
2	WAFER-MX1.25B-2PWB	7.55	16	7.5	2000	14	28000
3	WAFER-MX1.25B-3PWB	8.80					
4	WAFER-MX1.25B-4PWB	10.05	24	11.50		10	20000
5	WAFER-MX1.25B-5PWB	11.30					
6	WAFER-MX1.25B-6PWB	12.55					
7	WAFER-MX1.25B-7PWB	13.80					
8	WAFER-MX1.25B-8PWB	15.05					

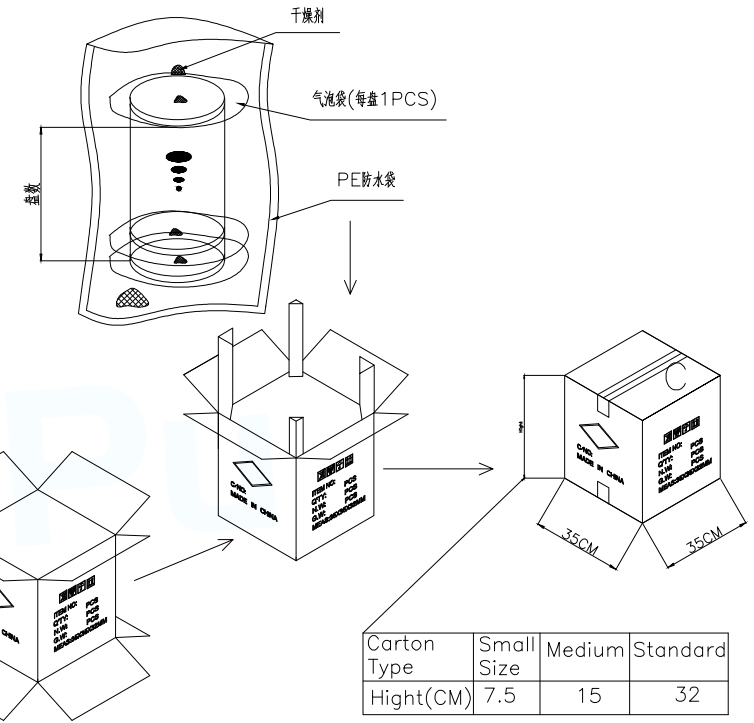

Carton Type	Small Size	Medium	Standard
Hight(CM)	7.5	15	32

MANUFACTURE DWG		东莞市讯普电子科技有限公司 DongGuan XunPu Electronics Co.,Ltd	
UNLESS OTHERWISE SPECIFIED TOLERANCES			TITLE:WAFER PH1.25mm H3.6mm W/ B 90°SMT
			PAR WAFER-MX1.25B-NPWB
DECIMALS:	ANGLES:		DWN
.X:±0.35	X':±5°		CHKD
.XX:±0.25	X.X':±3°	APVD	
.XXX:±0.15	X.XX':±1°	SCALE:1:1	UNIT:MM
CUSTOMER COPY		SIZE:A4	SHEET:1F1
			REV:A

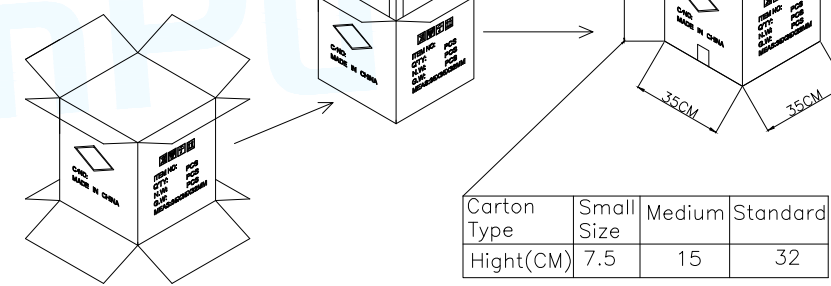
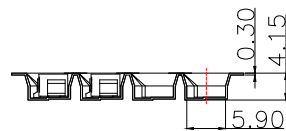
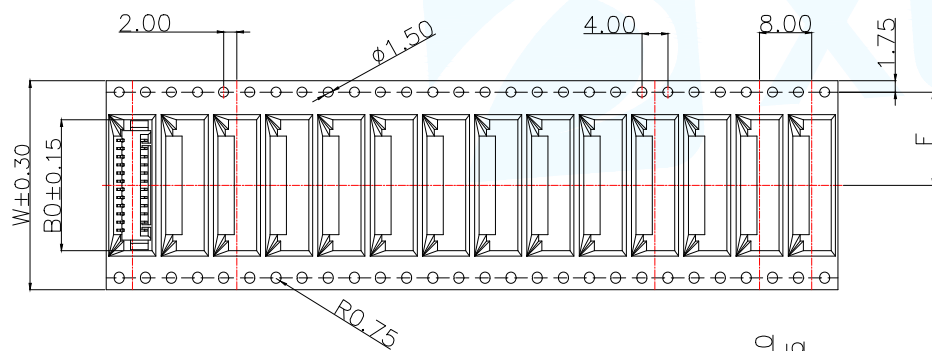
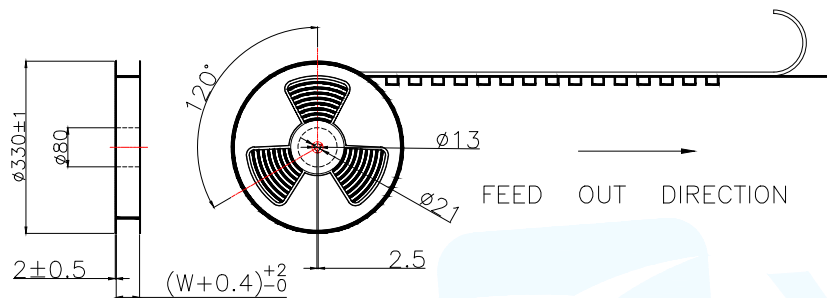
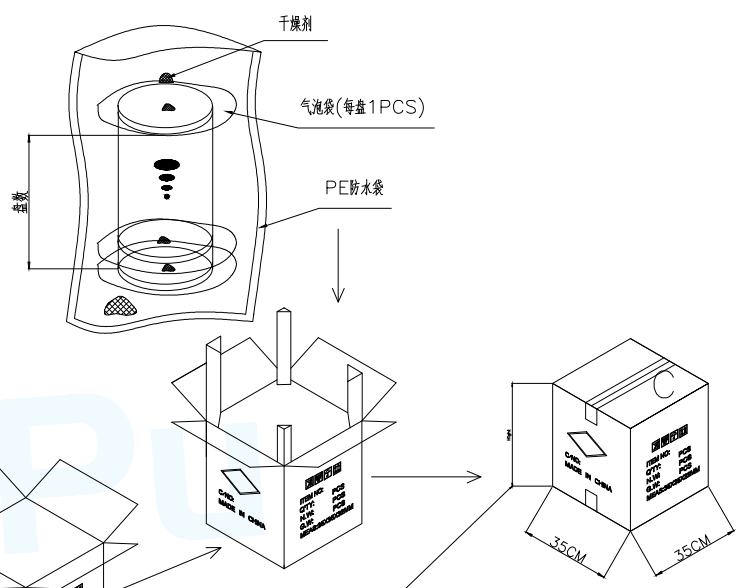
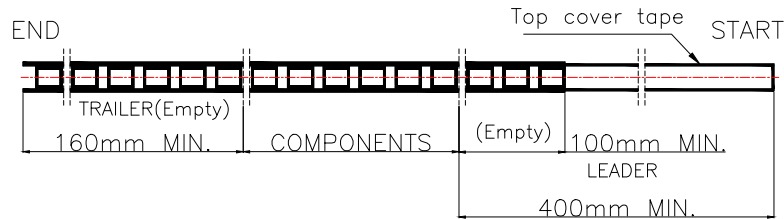

Carton Type	Small Size	Medium	Standard
Hight(CM)	7.5	15	32

PIN	NO.	Dim B0	Dim W	Dim F	PCS/RELL	RELL/CARTON	PCS/CARTON
9	WAFER-MX1.25B-9PWB	16.30	32	14.2	2000	8	16000
10	WAFER-MX1.25B-10PWB	17.55					
11	WAFER-MX1.25B-11PWB	18.80					
12	WAFER-MX1.25B-12PWB	20.05					
13	WAFER-MX1.25B-13PWB	21.30	44	20.2	6	12000	
14	WAFER-MX1.25B-14PWB	22.55					
15	WAFER-MX1.25B-15PWB	23.80					
16	WAFER-MX1.25B-16PWB	25.05					

MANUFACTURE DWG		东莞市讯普电子科技有限公司 DongGuan XunPu Electronics Co.,Ltd	
UNLESS OTHERWISE SPECIFIED TOLERANCES			TITLE:WAFER PH1.25mm H3.6mm W/ B 90°SMT
			PAR WAFER-MX1.25B-NPWB
DECIMALS:	ANGLES:		DWN
.X:±0.35	X':±5°		CHKD
.XX:±0.25	X.X':±3°	APVD	
.XXX:±0.15	X.XX':±1°	SCALE:1:1	UNIT:MM
CUSTOMER COPY		SIZE:A4	SHEET:1F1
			REV:A

X-ON Electronics

Largest Supplier of Electrical and Electronic Components

Click to view similar products for [Headers & Wire Housings](#) category:

Click to view products by [XUNPU](#) manufacturer:

Other Similar products are found below :

[57102-F02-18ULF](#) [58102-G61-06LF](#) [582553-1](#) [009176003701906](#) [01.001.5753.1](#) [0050291907](#) [02.125.8002.8](#) [609-3404](#) [61062-3](#)
[CSU011177004](#) [622-0430](#) [622-3653LF](#) [63453-116](#) [636-1030](#) [636-1427](#) [636-3427](#) [636-4007](#) [641938-9](#) [644827-2](#) [65495-038](#) [65692-001LF](#)
[65781-018](#) [65781-047](#) [65817-010LF](#) [65817-015LF](#) [66207-023LF](#) [67095-007LF](#) [67601157](#) [68631-112](#) [68645-018](#) [699319-000](#)
[M90C108951C](#) [70.362.1628.0](#) [70-4210](#) [70-4226B](#) [70-4853B](#) [707-5028](#) [71.350.2428.0](#) [71961-016LF](#) [733-134](#) [733-162](#) [754199-000](#) [760-](#)
[3052](#) [80.063.4001.1](#) [800-90-001-10-001000](#) [800-90-010-10-002000](#) [801-43-002-10-013000](#) [801-43-006-10-002000](#) [803-41-018-10-001000](#)
[803-43-024-10-001000](#)