

技术要求Specification:

1. 材质Material: PA66 UL94V-0:
2. 额定电流 Current rating:2.0A AC,DC
3. 额定电压 Voltage rating:250V AC,DC
4. 温度范围 Temperature range:-25℃to+85℃
5. 接触电阻 Contact resistance:≤20mΩ
6. 绝缘电阻Insulation resistance:≥1000MΩ
7. 耐压Withstand voltage:500V AC/minute
8. 塑件表面平整光洁, 无明显的毛刺、气泡、变形、浇口拉伤、缺料等不良现象。
Plastic surface smooth and clean, no obvious glitches, bubbles, distortion, gate strain, lack of material and other undesirable phenomena.

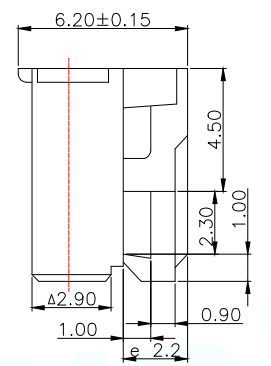

← F向

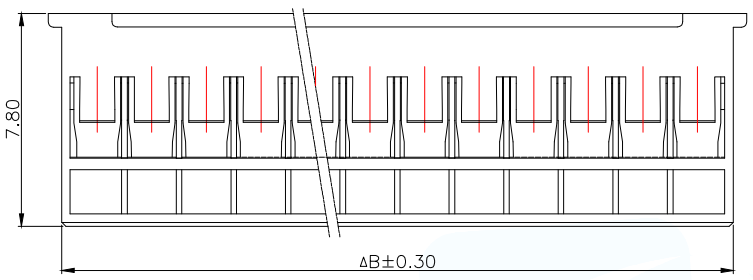
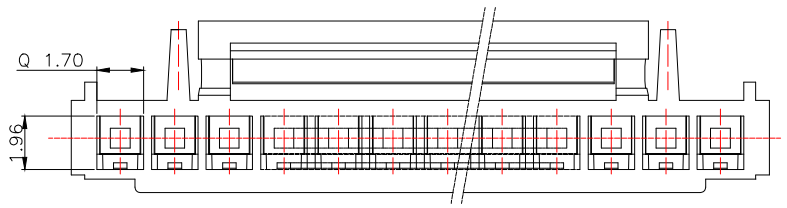
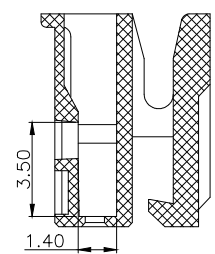
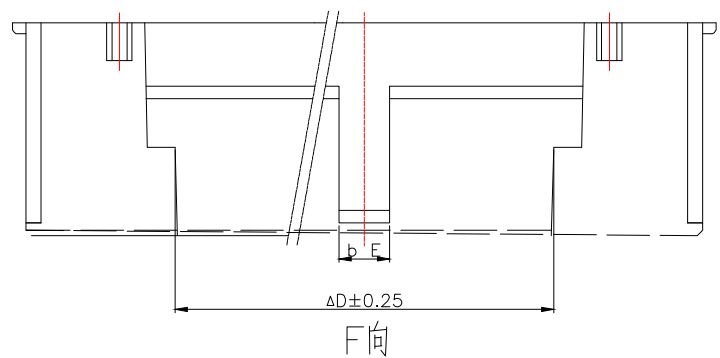
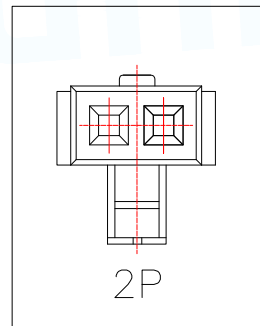
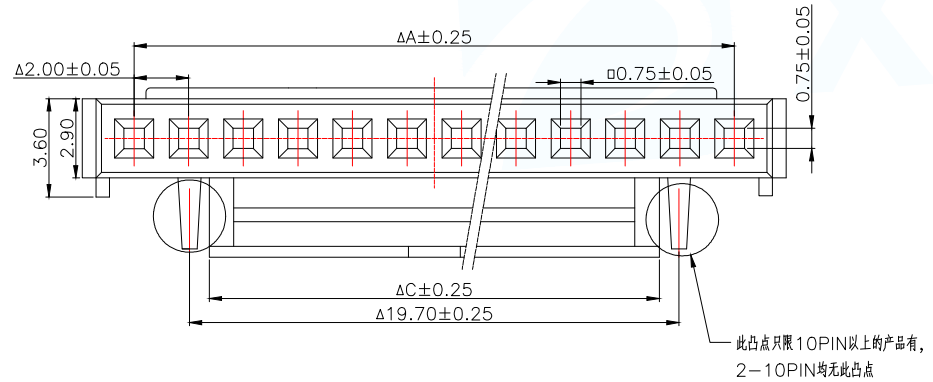

| Part No | Pin | A | B | C | D | E |
|-------------------|-----|-------|-------|-------|-------|------|
| WAfer-HY2.0-2PJK | 2 | 2.00 | 4.70 | 2.30 | 1.00 | 0.60 |
| WAfer-HY2.0-3PJK | 3 | 4.00 | 6.70 | 2.30 | 1.00 | 0.60 |
| WAfer-HY2.0-4PJK | 4 | 6.00 | 8.70 | 4.30 | 1.70 | 1.00 |
| WAfer-HY2.0-5PJK | 5 | 8.00 | 10.70 | 4.30 | 1.70 | 1.00 |
| WAfer-HY2.0-6PJK | 6 | 10.00 | 12.70 | 8.30 | 5.90 | 1.95 |
| WAfer-HY2.0-7PJK | 7 | 12.00 | 14.70 | 10.30 | 7.90 | 1.95 |
| WAfer-HY2.0-8PJK | 8 | 14.00 | 16.70 | 12.30 | 9.90 | 1.95 |
| WAfer-HY2.0-9PJK | 9 | 16.00 | 18.70 | 12.30 | 9.90 | 1.95 |
| WAfer-HY2.0-10PJK | 10 | 18.00 | 20.70 | 12.30 | 9.90 | 1.95 |
| WAfer-HY2.0-11PJK | 11 | 20.00 | 22.70 | 16.30 | 13.90 | 1.95 |
| WAfer-HY2.0-12PJK | 12 | 22.00 | 24.70 | 16.30 | 13.90 | 1.95 |
| WAfer-HY2.0-13PJK | 13 | 24.00 | 26.70 | 16.30 | 13.90 | 1.95 |
| WAfer-HY2.0-14PJK | 14 | 26.00 | 28.70 | 16.30 | 13.90 | 1.95 |
| WAfer-HY2.0-15PJK | 15 | 28.00 | 30.70 | 16.30 | 13.90 | 1.95 |
| WAfer-HY2.0-16PJK | 16 | 30.00 | 32.70 | 16.30 | 13.90 | 1.95 |

| | | | | |
|---------------------------------------|---------|---------------|---|------------------|
| MANUFACTURE DWG | | | 东莞市讯普电子科技有限公司 DongGuan XunPu Electronics Co.,Ltd | |
| UNLESS OTHERWISE SPECIFIED TOLERANCES | | | TITLE: HY2.0MM HOUSING | |
| DECIMALS: | ANGLES: | | PAR | WAfer-HY2.0-NPJK |
| .X±0.30 | X:±1° | | DWN | |
| .XX±0.20 | | CHKD | | |
| .XXX±0.10 | | APVD | | |
| | | SCALE 1:1 | UNIT:MM | |
| | | CUSTOMER COPY | SIZE:A4 | |
| | | | SHEET:1F1 | REV:A |

X-ON Electronics

Largest Supplier of Electrical and Electronic Components

Click to view similar products for [Headers & Wire Housings](#) category:

Click to view products by [XUNPU](#) manufacturer:

Other Similar products are found below :

[57102-F02-18ULF](#) [58102-G61-06LF](#) [582553-1](#) [009176003701906](#) [01.001.5753.1](#) [0050291907](#) [02.125.8002.8](#) [609-3404](#) [61062-3](#)
[CSU011177004](#) [622-0430](#) [622-3653LF](#) [63453-116](#) [636-1030](#) [636-1427](#) [636-3427](#) [636-4007](#) [641938-9](#) [644827-2](#) [65495-038](#) [65692-001LF](#)
[65781-018](#) [65781-047](#) [65817-010LF](#) [65817-015LF](#) [66207-023LF](#) [67095-007LF](#) [67601157](#) [68631-112](#) [68645-018](#) [699319-000](#)
[M90C108951C](#) [70.362.1628.0](#) [70-4210](#) [70-4226B](#) [70-4853B](#) [707-5028](#) [71.350.2428.0](#) [71961-016LF](#) [733-134](#) [733-162](#) [754199-000](#) [760-](#)
[3052](#) [80.063.4001.1](#) [800-90-001-10-001000](#) [800-90-010-10-002000](#) [801-43-002-10-013000](#) [801-43-006-10-002000](#) [803-41-018-10-001000](#)
[803-43-024-10-001000](#)