

REV.	Q'TY	ECN. NO.	APR.	DATE

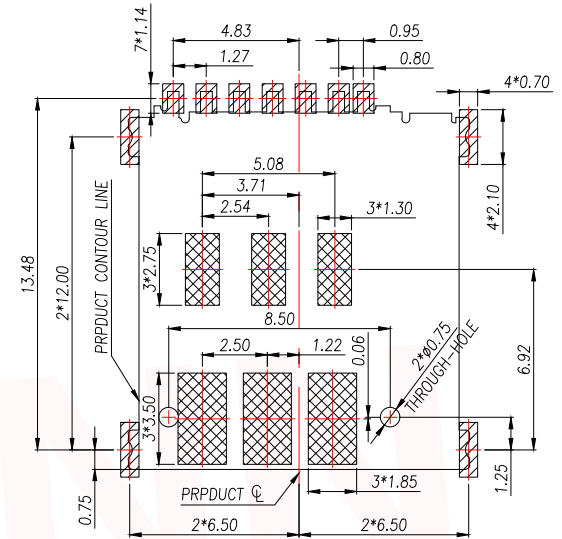
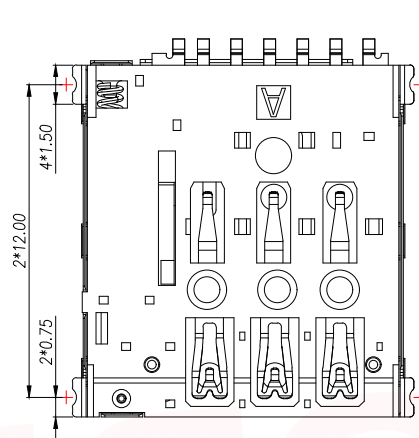
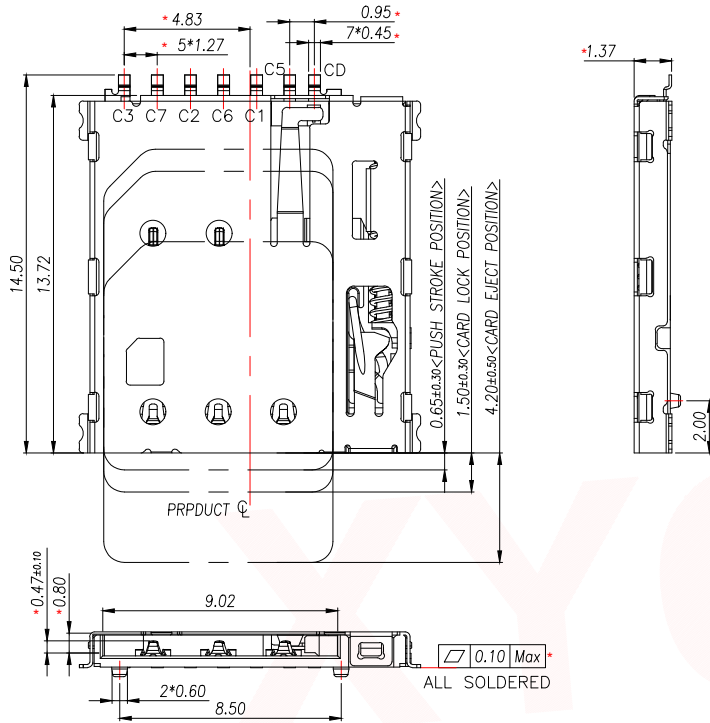

RECOMMENDED PCB LAYOUT TOP VIEW (TOLERANCE:±0.05)

RECOMMENDED MATAL MASK T=0.12mm

- SMT SOLDER AREA
- NO PATTERN AND VIA HOLE IN HTIS AREA

PART INSTRUCTIONS:

PART NUMBER	DESCRIPTION
SIM304-ZYD7AH1.37	WITH POST
SIM304-ZYB7AH1.37	NO POST

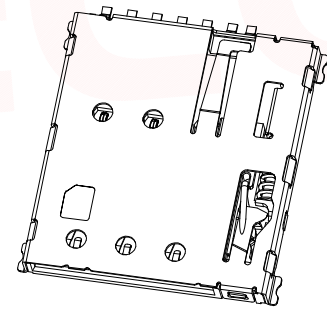

3D VIEW

PIIN/NO	ASSIGNMENT
C1	VCC
C2	RST
C3	CLK
CD	Detect Switch
C5	GND
C6	VPP
C7	I/O

- NOTES:
- MATERIAL:
HOUSING: High Temperature Thermoplastic
Terminal:Copper Alloy
Shell: Stainless Steel
 - PLATING:
Terminal:50u" Ni UNDERPLATED OVERALL
G/F PLATED ON CONTACT AREA AND SOLDER AREA
Shell:30u" Ni UNDERPLATED OVERALL
G/F PLATED ON CONTACT AREA AND SOLDER AREA
 - TECHNICAL SPECIALITY:
RATED VOLTAGE: 30V AC MAX.
CURRENT RATING: 0.5A MAX.
INSULATION RESISTANCE:1000MΩ MIN
CONTACT REISTANCE:50mΩ MAX
WITHSTANDING VOLTAGE: 500V AC FOR 1 MINUTES
OPERATING TEMPERATURE:
-25℃~+85℃ Humidity 80% R.H MAX
 - DIMENSIONS WITH MARK * "MUST BE MEASURE BY QC AND IPQC

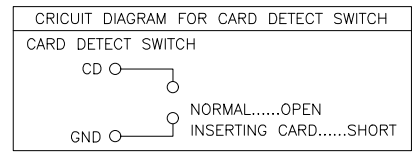

DIMENSION IN mm		TOLERANCE UNLESS OTHERWISE SPECIFIED		APR. Alex		TITLE: 1.37H 6+1PIN PUSH NANO SIM CARD CONNECTOR	
.X±0.35	X.*± 5'	.XX±0.25	.X*± 3'	CHK. Jack	DWG NO. SIM304-ZYD7AH1.37		
.XXX±0.15	.XX*± 1'	DRA. Can	PROJ.		CUSTOMER DRAWING		
SIZE A4		SCALE 1:1		SHEET 1/2		REV. A	

厦门市辛译精密电子有限公司
Xiamen XinYi Xyecom Electronics Co.,Ltd

REV.	Q'TY	ECN. NO.	APR.	DATE

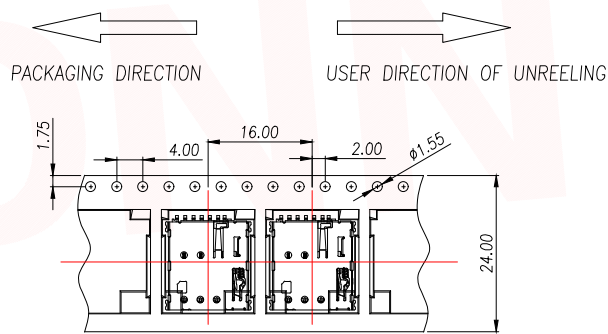
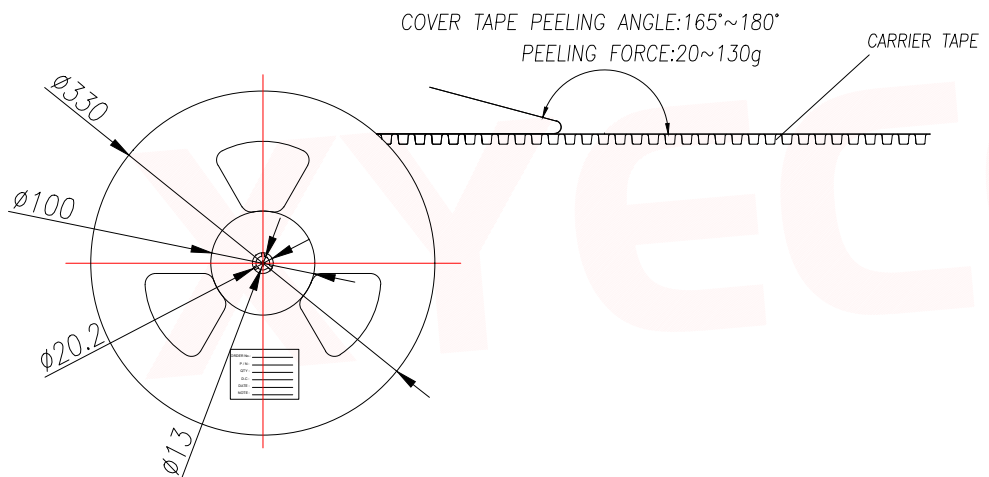
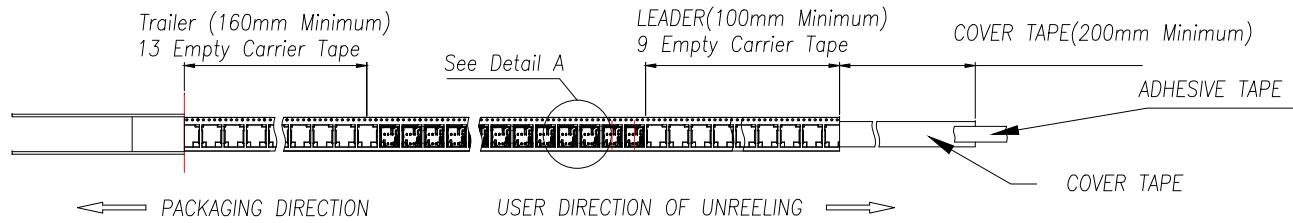

DETAIL A

2	SIM304-ZYD7AH1.37	1500	10	15000	350X350X340	
1	SIM304-ZYB7AH1.37	1500	10	15000	350X350X340	
ITEM	PRODUCT NO	QTY/REEL	REEL/CARTON	Kg/CARTON	QTY/CARTON	CARTON SIZE

DIMENSION IN mm		厦门市辛译精密电子有限公司 Xiamen XinYi Xyconn Electronics Co.,Ltd			
TOLERANCE UNLESS OTHERWISE SPECIFIED					
.X±0.35	X.*± 5°	APR.	Alex	TITLE: 1.37H 6+1PIN PUSH NANO SIM CARD CONNECTOR	
.XX±0.25	.X*± 3°	CHK.	Jack	DWG NO. SIM304-ZYD7AH1.37	
.XXX±0.15	.XX*± 1°	DRA.	Can	PROJ.	CUSTOMER DRAWING
		SIZE	A4	SCALE	1:1
		SHEET	2/2	REV.	A

X-ON Electronics

Largest Supplier of Electrical and Electronic Components

Click to view similar products for [Memory Card Connectors](#) category:

Click to view products by [XYECONN](#) manufacturer:

Other Similar products are found below :

[6407-249V-25273P](#) [6407-249V-25343P](#) [6426-201-21343](#) [69.920.0553.0](#) [MCR60A-98D-2.54DSA\(70\)](#) [809180410000000](#) [DM3AT-SF-PEJM5\(41\)](#) [IC11S-BUR-PNEJL\(71\)](#) [C70210M0083692](#) [2041353-2](#) [308-DS1P0811-192](#) [HM2P09PDR360N9LF](#) [10014744-011TLF](#) [11327-001](#) [11327-002](#) [NX1-32T-KT3K\(05\)](#) [95622-003LF](#) [84648-056HLF](#) [CCM03-3109 B LFT](#) [MS3116J10-6PW](#) [2309923-1](#) [61126-050CAHLF](#) [GTFP08432B1HR](#) [G85D1160022HHR](#) [SCE2MSDB76A121SN](#) [SCE2MSDZN76A121SN](#) [10014744-011ALF](#) [10014744-011LF](#) [10057542-1211FLF](#) [10067972-000LF](#) [10067972-050LF](#) [10122302-20110LF](#) [G85D1162022HHR](#) [TF-05A](#) [XKNANO-1412](#) [SMN-304-ARP6](#) [MIS11-S1F1-2000-A](#) [SMN-308-ARSP7](#) [MCS-302S-KT1B](#) [SMN-308-ACSP7](#) [K-DYX-008](#) [K-DYX-004](#) [HYCW126-TF18-150B](#) [C7024-03](#) [SMO-1030](#) [MCS-110-KT](#) [SIM-217](#) [SNO-1355-KT](#) [SMO-1025-P10](#) [SIM-211S-P6](#)