

REV.	Q'TY	ECN. NO.	APR.	DATE

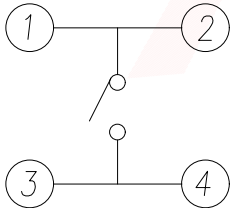

CIRCUIT DIAGRAM

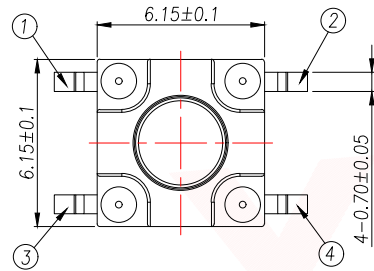
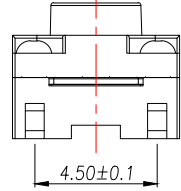
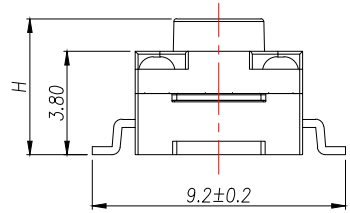
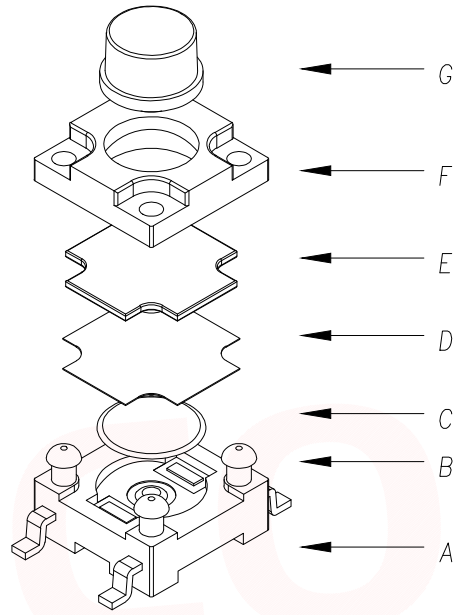
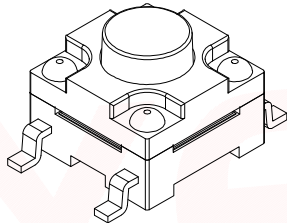

The Main Thchnology Performance

Rate voltage,current	50mA DC12V
Contact resistance	<100mΩ
Operating force	±30gf
Travel	0.30±0.10mm
Insulated resistance	>100MΩ
Dielectric strength	>250VAC/1min
IP rating	IP67

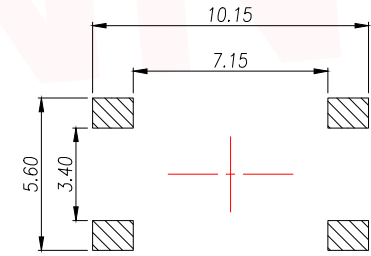

PCB.WELDING DRAWING

ITEM	DESCRIPTION	MATERIAL	QTY	FINSH/COLOR
G	按钮	PPA	1	黑色
F	盖板	PPA	1	黑色
E	防尘膜	硅胶	1	黑色
D	防水层	聚酰亚胺	1	橙黄色
C	弹片	不锈钢	1	镀银
B	本体	PPA	1	黑色
A	卡件	黄铜	1	镀银

T S O 1 7 A - T B Y 1

力度: F: 250G E: 180G
 高度: H4.3 H4.5

H	H	H
4.3	6.5	9.5
4.5	7.0	10.0
4.8	7.5	10.5
5.0	8.0	11.0
5.5	8.5	
6.0	9.0	

DIMENSION IN mm		厦门市辛译精密电子有限公司 Xiamen XinYi Xyconn Electronics Co.,Ltd	
TOLERANCE UNLESS OTHERWISE SPECIFIED		APR. Alex	TITLE: 6x6 SMD TACT SWITCH
.X±0.35	.X*±5°	CHK. Jack	DWG NO. TS017A-TBY1EHX
.XX±0.25	.X*±3°	DRA. Can	PROJ. CUSTOMER DRAWING
.XXX±0.15	.XX*±1°	SIZE A4	SCALE 1:1 SHEET 1/1 REV. A

X-ON Electronics

Largest Supplier of Electrical and Electronic Components

Click to view similar products for [Tactile Switches](#) category:

Click to view products by [XYECONN](#) manufacturer:

Other Similar products are found below :

[6407-250V-25273P](#) [ADTSA62NV](#) [B3F-3123](#) [1977177-8](#) [1977266-1](#) [ADTSA63NV](#) [ADTSM21NSVTR](#) [ADTSM25RVTR](#) [ADTSM32NVTR](#)
[ADTSMW64RV](#) [1977120-6](#) [FSMRA4JHA04](#) [GS4.70F300QP](#) [KSC241J SP DELTA LFS](#) [3FTL600RAS](#) [3FTL640RAS](#) [6407-250V-25343P](#)
[ADTSM31NVTR](#) [2-1977120-7](#) [TSJW-5.2-260-TR](#) [Y651050400P](#) [KMT011MNGJLHS](#) [70-201.0](#) [ADTSG648NV](#) [ADTSM62KSVTR](#)
[ADTSM648NV](#) [95C06E3RAT](#) [3ATH9Q](#) [FSMRA8JHA04](#) [HARS0073](#) [Y33R411N9FPLFT](#) [Y33R51139FPLFT](#) [Y31C01402FPLFS](#)
[PTS645SK50SMTR92](#) [ADTSM32NVB](#) [KMS233GPWTLFG](#) [Y78B64124FP](#) [Y31CJ244KFP LFS](#) [Y96D113G0FP LFS](#) [Y33A812C5FP LFT](#)
[Y56B2D120FP LFS](#) [Y31C5144KFP LFS](#) [PTS645 DVM83-BN125-2 LFS](#) [B3W 1000G](#) [KSC621G OL LFS](#) [B3F 1002C](#) [B3F 0047H](#) [B3W](#)
[1002C](#) [B3F 5001G](#) [B3W 1100C](#)