

|      |      |          |      |      |
|------|------|----------|------|------|
| REV. | Q'TY | ECN. NO. | APR. | DATE |
|      |      |          |      |      |

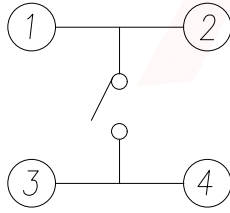

CIRCUIT DIAGRAM

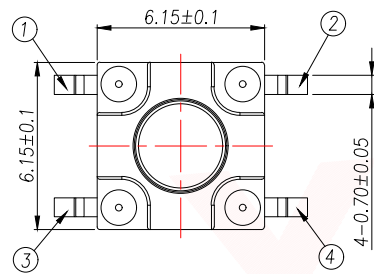
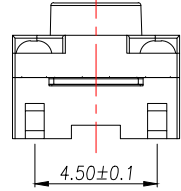
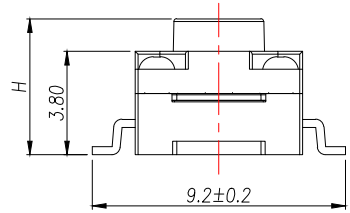
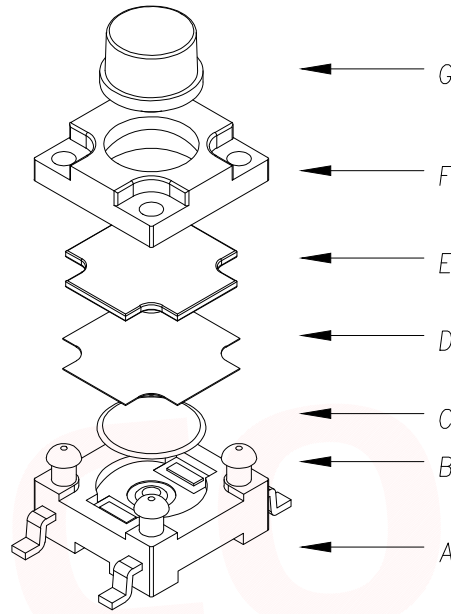
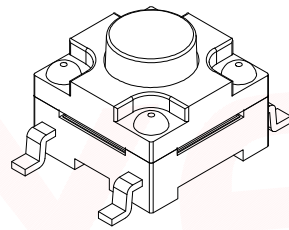

The Main Thchnology Performance

|                      |              |
|----------------------|--------------|
| Rate voltage,current | 50mA DC12V   |
| Contact resistance   | <100mΩ       |
| Operating force      | ±30gf        |
| Travel               | 0.30±0.10mm  |
| Insulated resistance | >100MΩ       |
| Dielectric strength  | >250VAC/1min |
| IP rating            | IP67         |

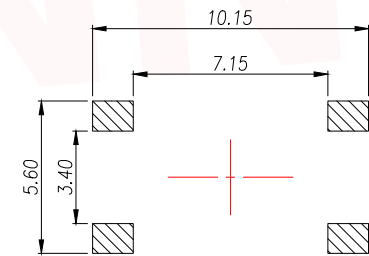

PCB.WELDING DRAWING

|      |             |          |     |             |
|------|-------------|----------|-----|-------------|
| G    | 按钮          | PPA      | 1   | 黑色          |
| F    | 盖板          | PPA      | 1   | 黑色          |
| E    | 防尘膜         | 硅胶       | 1   | 黑色          |
| D    | 防水层         | 聚酰亚胺     | 1   | 橙黄色         |
| C    | 弹片          | 不锈钢      | 1   | 镀银          |
| B    | 本体          | PPA      | 1   | 黑色          |
| A    | 卡件          | 黄铜       | 1   | 镀银          |
| ITEM | DESCRIPTION | MATERIAL | QTY | FINSH/COLOR |

T S O 1 7 A - T B Y 1

力度: F: 250G E: 180G  
 高度: H4.3 H4.5

|     |     |      |
|-----|-----|------|
| H   | H   | H    |
| 4.3 | 6.5 | 9.5  |
| 4.5 | 7.0 | 10.0 |
| 4.8 | 7.5 | 10.5 |
| 5.0 | 8.0 | 11.0 |
| 5.5 | 8.5 |      |
| 6.0 | 9.0 |      |

|                                      |         |  |                            |
|--------------------------------------|---------|--|----------------------------|
| DIMENSION IN mm                      |         | 厦门市辛译精密电子有限公司<br>Xiamen XinYi Xyconn Electronics Co.,Ltd |                            |
| TOLERANCE UNLESS OTHERWISE SPECIFIED |         | APR. Alex  | TITLE: 6x6 SMD TACT SWITCH |
| .X±0.35                              | .X*±5°  | CHK. Jack  | DWG NO. TS017A-TBY1FHX     |
| .XX±0.25                             | .X*±3°  | DRA. Can   | PROJ.  CUSTOMER DRAWING    |
| .XXX±0.15                            | .XX*±1° | SIZE A4  | SCALE 1:1 SHEET 1/1 REV. A |

## X-ON Electronics

Largest Supplier of Electrical and Electronic Components

*Click to view similar products for [Tactile Switches](#) category:*

*Click to view products by [XYECONN](#) manufacturer:*

Other Similar products are found below :

[6407-250V-25273P](#) [ADTSA62NV](#) [B3F-3123](#) [1977177-8](#) [1977266-1](#) [ADTSA63NV](#) [ADTSM21NSVTR](#) [ADTSM25RVTR](#) [ADTSM32NVTR](#)  
[ADTSMW64RV](#) [1977120-6](#) [FSMRA4JHA04](#) [GS4.70F300QP](#) [KSC241J SP DELTA LFS](#) [3FTL600RAS](#) [3FTL640RAS](#) [6407-250V-25343P](#)  
[ADTSM31NVTR](#) [2-1977120-7](#) [TSJW-5.2-260-TR](#) [Y651050400P](#) [KMT011MNGJLHS](#) [70-201.0](#) [ADTSG648NV](#) [ADTSM62KSVTR](#)  
[ADTSM648NV](#) [95C06E3RAT](#) [3ATH9Q](#) [FSMRA8JHA04](#) [HARS0073](#) [Y33R411N9FPLFT](#) [Y33R51139FPLFT](#) [Y31C01402FPLFS](#)  
[PTS645SK50SMTR92](#) [ADTSM32NVB](#) [KMS233GPWTLFG](#) [Y78B64124FP](#) [Y31CJ244KFP LFS](#) [Y96D113G0FP LFS](#) [Y33A812C5FP LFT](#)  
[Y56B2D120FP LFS](#) [Y31C5144KFP LFS](#) [PTS645 DVM83-BN125-2 LFS](#) [B3W 1000G](#) [KSC621G OL LFS](#) [B3F 1002C](#) [B3F 0047H](#) [B3W](#)  
[1002C](#) [B3F 5001G](#) [B3W 1100C](#)