

| | | | | |
|------|------|----------|------|------|
| REV. | Q'TY | ECN. NO. | APR. | DATE |
| | | | | |

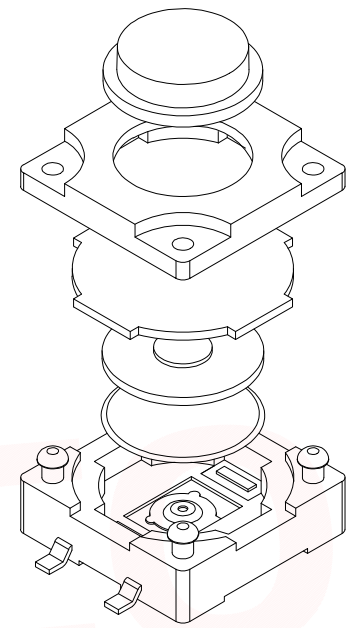

The Main Thchnology Performance

| | |
|----------------------|--------------|
| Rate voltage.current | 50mA DC12V |
| Contact resistance | ≤100mΩ |
| Operating force | ±30gf |
| Travel | 0.30±0.10mm |
| Insulated resistance | >100MΩ |
| Dielectric strength | >250VAC/1min |
| IP rating | IP67 |

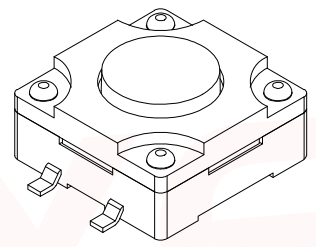
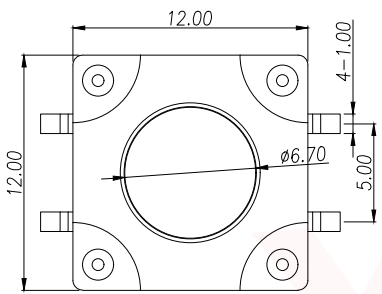
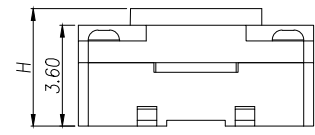
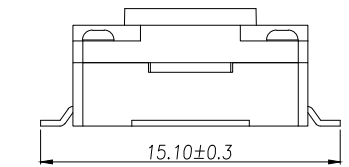
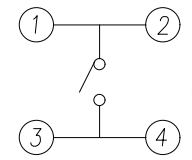

CIRCUIT DIAGRAM

| ITEM | DESCRIPTION | MATERIAL | QTY | FINSH/COLOR |
|------|-------------|----------|-----|-------------|
| G | 按钮 | PPA | 1 | 黑色 |
| F | 盖板 | PPA | 1 | 黑色 |
| E | 防尘胶 | 硅胶 | 1 | 黑色 |
| D | 内嵌 | PPA | 1 | 黑色 |
| C | 弹片 | 磷铜/不锈钢 | 1 | 镀镍 |
| B | 本体 | PPA | 1 | 黑色 |
| A | 卡件 | 黄铜 | 1 | 镀镍 |

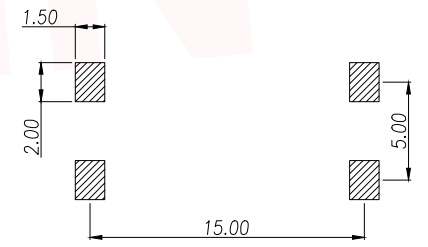

PCB.WELDING DRAWING

T S O 1 8 A - T B Y 1

力度: F: 250G E: 180G
 高度: H4.3 H4.5

| H | H | H |
|-----|-----|------|
| 4.3 | 6.5 | 9.5 |
| 4.5 | 7.0 | 10.0 |
| 4.8 | 7.5 | 10.5 |
| 5.0 | 8.0 | 11.0 |
| 5.5 | 8.5 | 11.5 |
| 6.0 | 9.0 | 12.0 |

| DIMENSION IN mm | | TOLERANCE UNLESS OTHERWISE SPECIFIED | | APR. Alex | | TITLE: 12x12 SMD TACT SWITCH | |
|-----------------|----------|--------------------------------------|------------------------|-----------|-----------|------------------------------|--|
| .X±0.35 | X.*± 5* | CHK. Jack | DWG NO. TS018A-TBY1FHX | PROJ. | | CUSTOMER DRAWING | |
| .XX±0.25 | .X*± 3* | DRA. Can | SIZE A4 | SCALE 1:1 | SHEET 1/1 | REV. A | |
| .XXX±0.15 | .XX*± 1* | | | | | | |

厦门市辛译精密电子有限公司
 Xiamen XinYi Xyecomm Electronics Co.,Ltd

X-ON Electronics

Largest Supplier of Electrical and Electronic Components

Click to view similar products for [Tactile Switches](#) category:

Click to view products by [XYECONN](#) manufacturer:

Other Similar products are found below :

[6407-250V-25273P](#) [ADTSA62NV](#) [B3F-3123](#) [1977177-8](#) [1977266-1](#) [ADTSA63NV](#) [ADTSM21NSVTR](#) [ADTSM25RVTR](#) [ADTSM32NVTR](#)
[ADTSMW64RV](#) [1977120-6](#) [FSMRA4JHA04](#) [GS4.70F300QP](#) [KSC241J SP DELTA LFS](#) [3FTL600RAS](#) [3FTL640RAS](#) [6407-250V-25343P](#)
[ADTSM31NVTR](#) [2-1977120-7](#) [TSJW-5.2-260-TR](#) [Y651050400P](#) [KMT011MNGJLHS](#) [70-201.0](#) [ADTSG648NV](#) [ADTSM62KSVTR](#)
[ADTSM648NV](#) [95C06E3RAT](#) [3ATH9Q](#) [FSMRA8JHA04](#) [HARS0073](#) [Y33R411N9FPLFT](#) [Y33R51139FPLFT](#) [Y31C01402FPLFS](#)
[PTS645SK50SMTR92](#) [ADTSM32NVB](#) [KMS233GPWTLFG](#) [Y78B64124FP](#) [Y31CJ244KFP LFS](#) [Y96D113G0FP LFS](#) [Y33A812C5FP LFT](#)
[Y56B2D120FP LFS](#) [Y31C5144KFP LFS](#) [PTS645 DVM83-BN125-2 LFS](#) [B3W 1000G](#) [KSC621G OL LFS](#) [B3F 1002C](#) [B3F 0047H](#) [B3W](#)
[1002C](#) [B3F 5001G](#) [B3W 1100C](#)