

REV.	Q'TY	ECN. NO.	APR.	DATE

PRELIMINARY  
DESIGN IS SUBJECT  
TO CHANGE WITHOUT  
PRIOR NOTICE

NOTES:

- 1.Working temp:-25°C~85°C.
- 2.Voltage rating:100V AV/DC(rms)
- 3.Contact resistance:20mΩ max.
- 4.Insulation resistance:1000MΩ min.
- 5.Current rating:2A AV/DC
- 6.Withstanding Voltage:800V AC/minute
- 7.Pin Retention Force:15N min.
- 8.Housing material:LCP UL94-V0,Natural
- 9.Terminal materl:Brass,  
plating Ni 50u" min , plating Tin 100u"min.
- 10.Solder tab material:Brass,  
plating Ni 50u" min , plating Tin 100u"min.

N-0.50 (SQ) 2.00(PITCH)

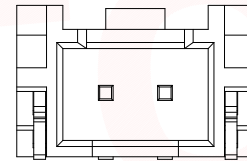
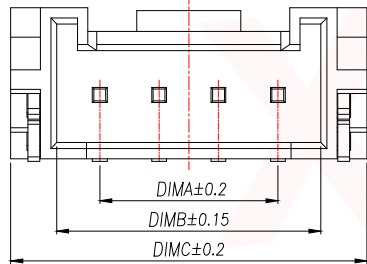
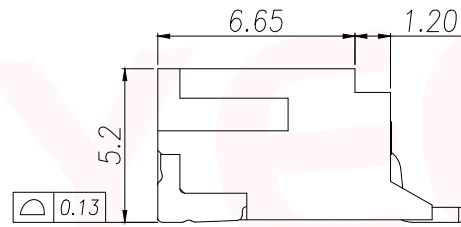
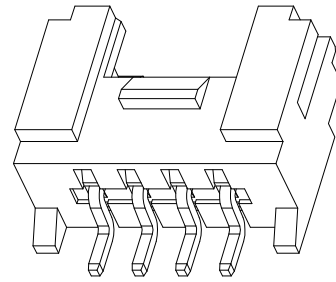
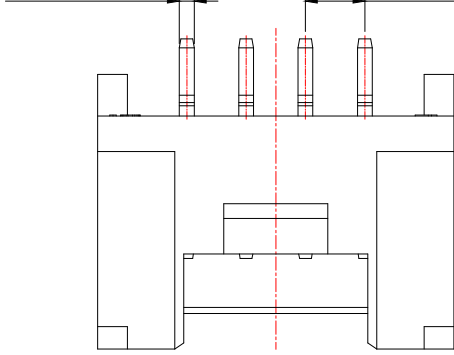

2 PIN 结构样式  
(Structural style)

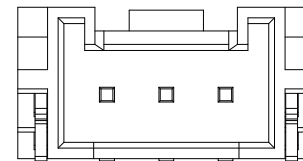

3 PIN 结构样式  
(Structural style)

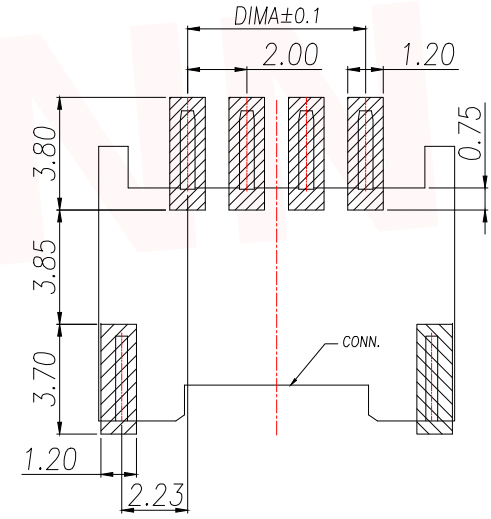

RECOMMENDED PCB LAYOUT TOP VIEW (TOLERANCE:±0.05)

▨ SMT SOLDER AREA

PIN	NO.	Dim A	Dim B	Dim C
2	XY-HY2.0-2A61	2.00	4.90	8.00
3	XY-HY2.0-3A61	4.00	6.90	10.00
4	XY-HY2.0-4A61	6.00	8.90	12.00
5	XY-HY2.0-5A61	8.00	10.90	14.00
6	XY-HY2.0-6A61	10.00	12.90	16.00
7	XY-HY2.0-7A61	12.00	14.90	18.00
8	XY-HY2.0-8A61	14.00	16.90	20.00
9	XY-HY2.0-9A61	16.00	18.90	22.00
10	XY-HY2.0-10A61	18.00	20.90	24.00
11	XY-HY2.0-11A61	20.00	22.90	26.00
12	XY-HY2.0-12A61	22.00	24.90	28.00
13	XY-HY2.0-13A61	24.00	26.90	30.00
14	XY-HY2.0-14A61	26.00	28.90	32.00
15	XY-HY2.0-15A61	28.00	30.90	34.00
16	XY-HY2.0-16A61	30.00	32.90	36.00

DIMENSION IN mm		TOLERANCE UNLESS OTHERWISE SPECIFIED		厦门市辛译精密电子有限公司 Xiamen XinYi Xyconn Electronics Co.,Ltd	
.X±0.35	X.*± 5°	APR.	Alex	TITLE: WAFER 2.00mm H5.2mm W/ B 90°SMT	
.XX±0.25	.X.*± 3°	CHK.	Jack	DWG NO. XY-HY2.0-NA61	
.XXX±0.15	.XX.*± 1°	DRA.	Can	PROJ.  CUSTOMER DRAWING	
		SIZE A4	SCALE 1:1	SHEET 1/3	REV. A

REV.	Q'TY	ECN. NO.	APR.	DATE

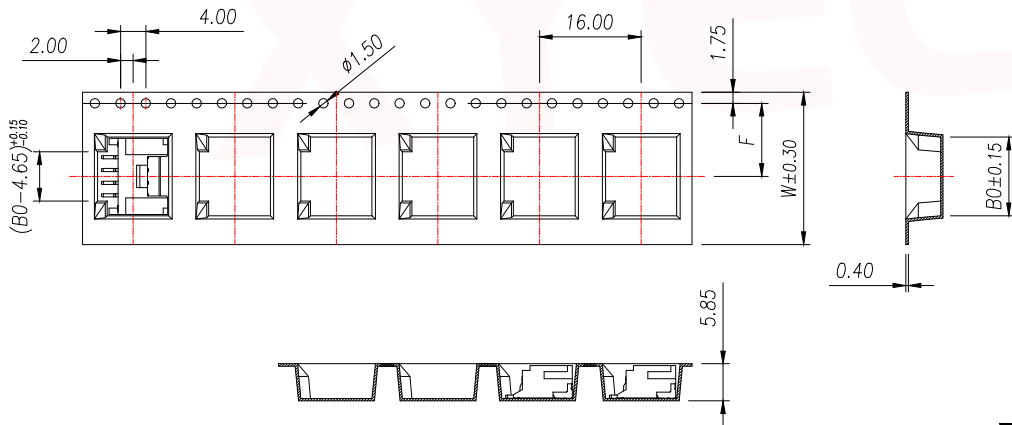
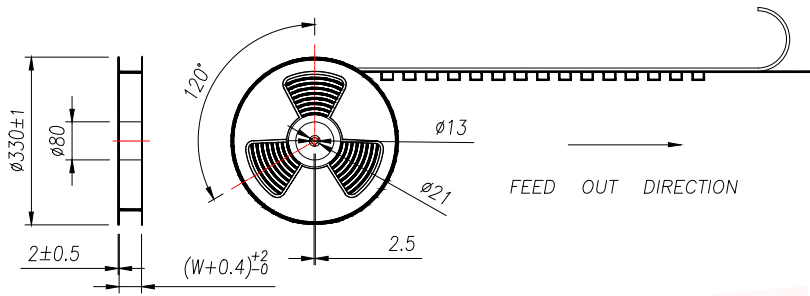
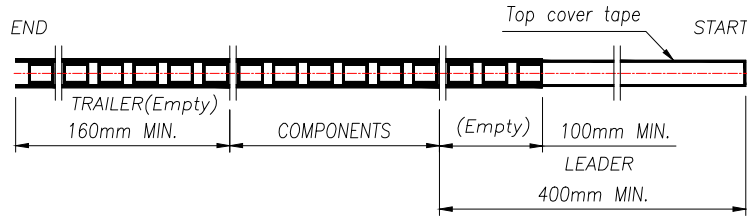

PIN	NO.	Dim B0	Dim W	Dim F	PCS/RELL	RELL/CARTON	PCS/CARTON
2	XY-HY2.0-NA61	8.40	16	7.5	700	14	9800
3	XY-HY2.0-NA61	10.40	24	11.50		10	7000
4	XY-HY2.0-NA61	12.40					
5	XY-HY2.0-NA61	14.40					
6	XY-HY2.0-NA61	16.40					

PRELIMINARY DESIGN IS SUBJECT TO CHANGE WITHOUT PRIOR NOTICE

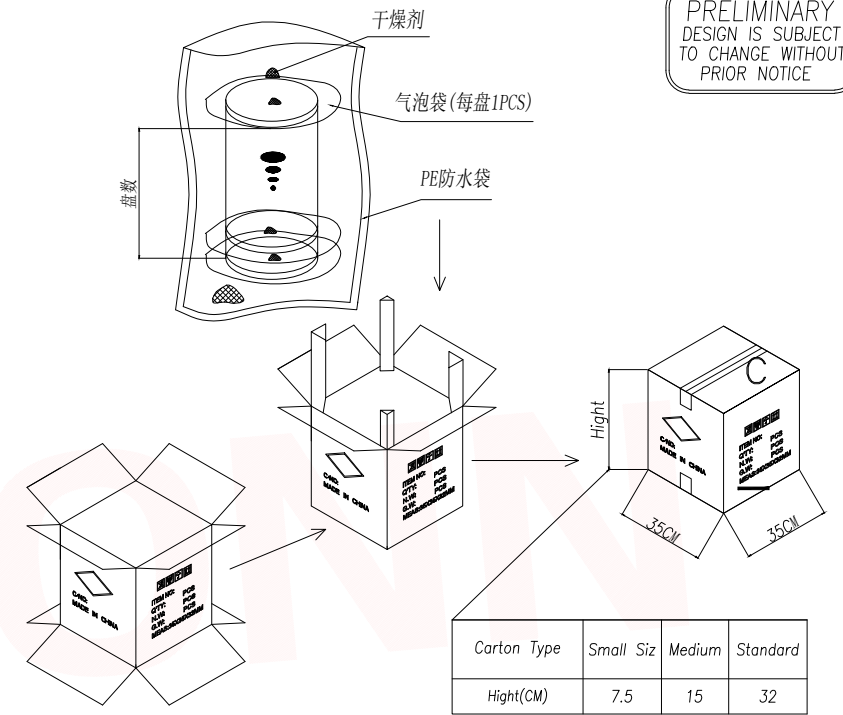

Carton Type	Small Siz	Medium	Standard
Hight(CM)	7.5	15	32

- NOTE:
- 1.10 SPROCKET HOLE PITCH CUMULATIVE TOLERANCE  $\pm 0.2\text{mm}$ .
  - 2.CARRIER CAMBER NOT TO EXCEED 1mm IN 100mm.
  - 3.ALL DIMENSIONS MEET EIA-481 REQUIREMENTS.
  - 4.MATERIAL: CLEAR ANTISTATIC PS, COLD SEALING.
  - 5.THICKNESS:  $0.40 \pm 0.05\text{mm}$ .
  - 6.PACKING LENGTH PER REEL: 11.52 METERS.
  - 7.COMPONENT LOAD PER REEL: 700 PCS.

DIMENSION IN mm		厦门市辛译精密电子有限公司 Xiamen XinYi Xyconn Electronics Co.,Ltd			
TOLERANCE UNLESS OTHERWISE SPECIFIED		TITLE: WAFER 2.00mm H5.2mm W/ B 90°SMT			
.X $\pm$ 0.35	X.* $\pm$ 5°	APR.	Alex	DWG NO. XY-HY2.0-NA61	
.XX $\pm$ 0.25	.X* $\pm$ 3°	CHK.	Jack	PROJ.  CUSTOMER DRAWING	
.XXX $\pm$ 0.15	.XX* $\pm$ 1°	DRA.	Can	SIZE A4	SCALE 1:1
			SHEET 2/3	REV. A	

REV.	Q'TY	ECN. NO.	APR.	DATE

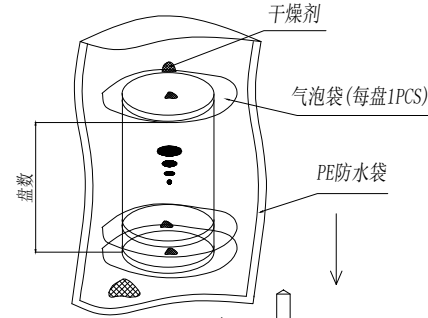
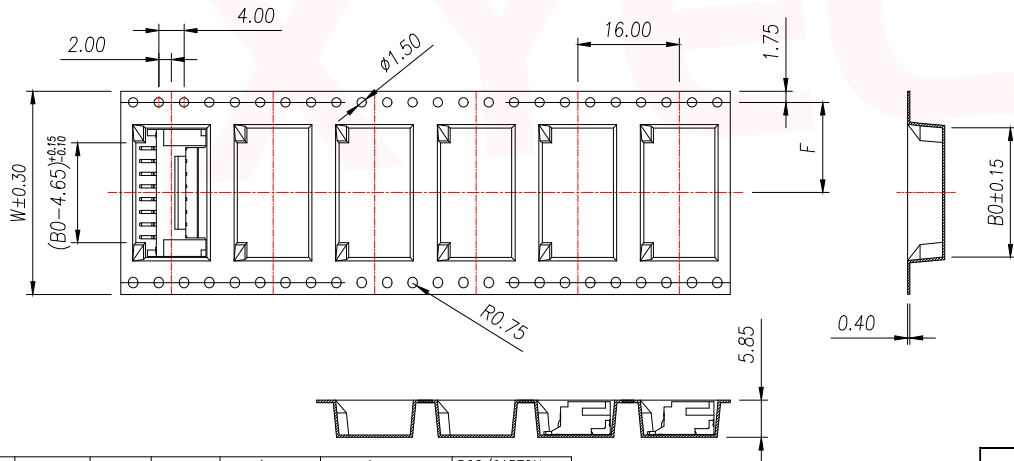
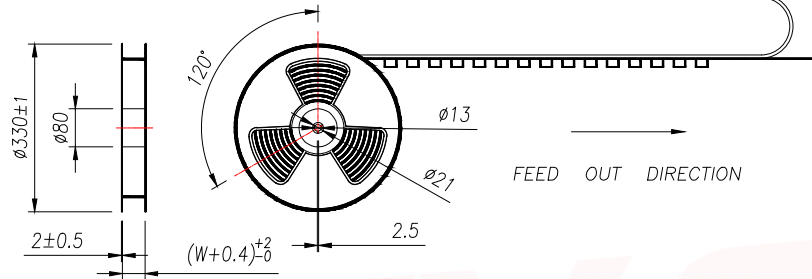
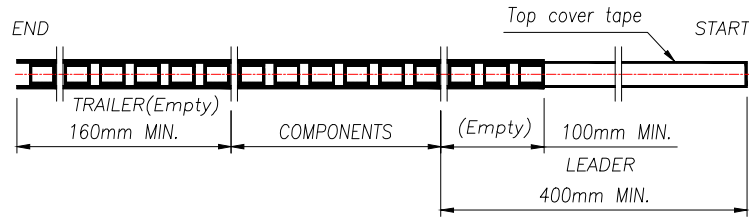

PRELIMINARY DESIGN IS SUBJECT TO CHANGE WITHOUT PRIOR NOTICE

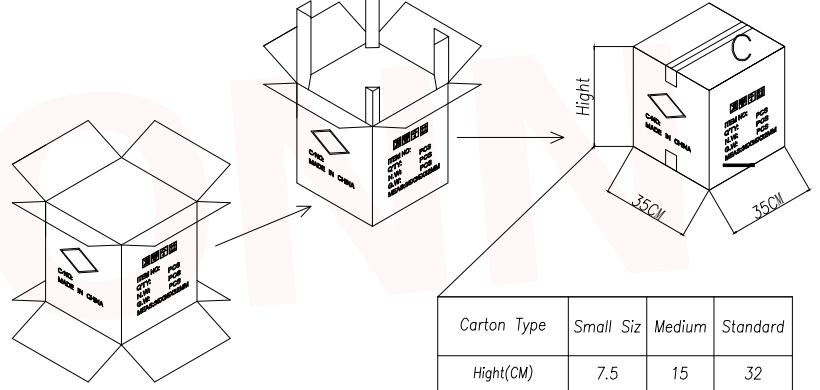

Carton Type	Small Siz	Medium	Standard
Hight(CM)	7.5	15	32

- NOTE:
- 1.10 SPROCKET HOLE PITCH CUMULATIVE TOLERANCE  $\pm 0.2\text{mm}$ .
  - 2.CARRIER CAMBER NOT TO EXCEED 1mm IN 100mm.
  - 3.ALL DIMENSIONS MEET EIA-481 REQUIREMENTS.
  - 4.MATERIAL: CLEAR ANTISTATIC PS, COLD SEALING.
  - 5.THICKNESS:  $0.40 \pm 0.05\text{mm}$ .
  - 6.PACKING LENGTH PER REEL: 11.52 METERS.
  - 7.COMPONENT LOAD PER REEL: 700 PCS.

PIN	NO.	Dim B0	Dim W	Dim F	PCS/RELL	RELL/CARTON	PCS/CARTON
7	XY-HY2.0-7A61	18.40	32	14.2	700	8	5600
8	XY-HY2.0-8A61	20.40					
9	XY-HY2.0-9A61	22.40					
10	XY-HY2.0-10A61	24.40	44	20.2	700	6	4200
11	XY-HY2.0-11A61	26.40					
12	XY-HY2.0-12A61	28.40					
13	XY-HY2.0-13A61	30.40					
14	XY-HY2.0-14A61	32.40	56	26.2	700	5	3500
15	XY-HY2.0-15A61	34.40					
16	XY-HY2.0-16A61	36.40					

DIMENSION IN mm		TOLERANCE UNLESS OTHERWISE SPECIFIED		厦门市辛译精密电子有限公司 Xiamen XinYi Xyconn Electronics Co.,Ltd			
.X $\pm 0.35$	X.* $\pm 5^\circ$	APR.	Alex	TITLE: WAFER 2.00mm H5.2mm W/ B 90°SMT			
.XX $\pm 0.25$	.X.* $\pm 3^\circ$	CHK.	Jack	DWG NO. XY-HY2.0-NA61			
.XXX $\pm 0.15$	.XX.* $\pm 1^\circ$	DRA.	Can	PROJ.		CUSTOMER DRAWING	
SIZE A4	SCALE 1:1	SHEET 3/3	REV. A				

## X-ON Electronics

Largest Supplier of Electrical and Electronic Components

*Click to view similar products for [Headers & Wire Housings](#) category:*

*Click to view products by [XYECONN](#) manufacturer:*

Other Similar products are found below :

[0015917161](#) [0022155065](#) [57102-F02-18ULF](#) [58102-G61-06LF](#) [582553-1](#) [01.001.5753.1](#) [0050291907](#) [02.125.8002.8](#) [609-3404](#) [61062-3](#)  
[CSU011177004](#) [622-0430](#) [622-3653LF](#) [63453-116](#) [636-1030](#) [636-1427](#) [636-3427](#) [636-4007](#) [641938-9](#) [65495-038](#) [65692-001LF](#) [65781-018](#)  
[65781-047](#) [65817-010LF](#) [65817-015LF](#) [67095-007LF](#) [67601157](#) [68631-112](#) [68645-018](#) [699319-000](#) [70.362.1628.0](#) [70-4210](#) [70-4226B](#) [70-](#)  
[4853B](#) [71.350.2428.0](#) [733-134](#) [733-162](#) [760-3052](#) [MHR-64-VUAL](#) [80.063.4001.1](#) [800-90-001-10-001000](#) [801-43-002-10-013000](#)  
[801-43-006-10-002000](#) [803-43-024-10-001000](#) [803-93-012-10-001000](#) [8-1437020-4](#) [819-22-004-30-001101](#) [820-22-006-30-001101](#)  
[820-22-008-30-001101](#) [821-22-002-10-001101](#)