

REV.	Q'TY	ECN. NO.	APR.	DATE

PRELIMINARY  
DESIGN IS SUBJECT  
TO CHANGE WITHOUT  
PRIOR NOTICE

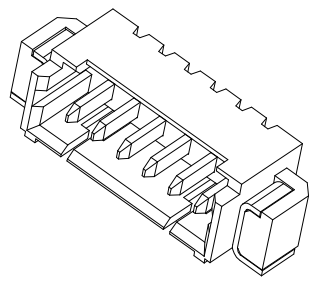

- NOTES:
- Working temp:-25°C~85°C.
  - Voltage rating:100V AC/DC(rms)
  - Contact resistance:40mΩ max.
  - Insulation resistance:100MΩ min.
  - Current rating:1A AV/DC
  - Withstanding Voltage:500V AC/minute
  - Pin Retention Force:5N min.
  - Housing material:LCP UL94-V0,Natural
  - Terminal mater:Brass,  
plating Ni 50u" min , plating Tin 100u"min.
  - Solder tab material:Brass,  
plating Ni 50u" min , plating Tin 100u"min.

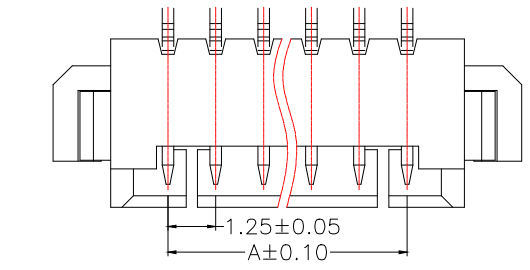
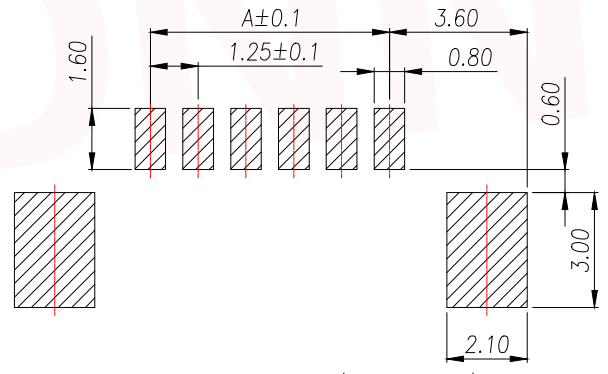
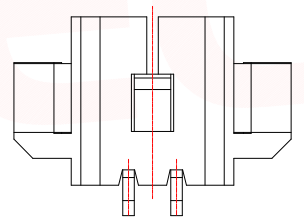
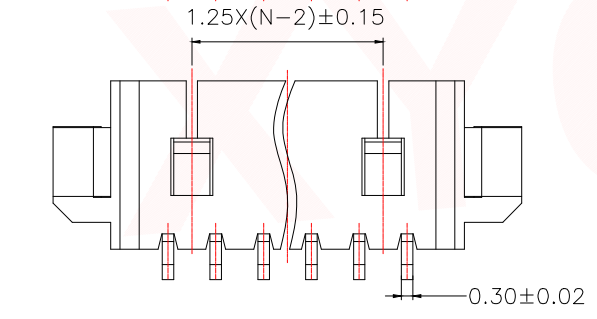
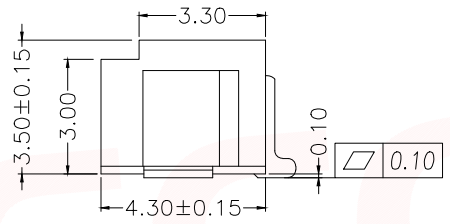
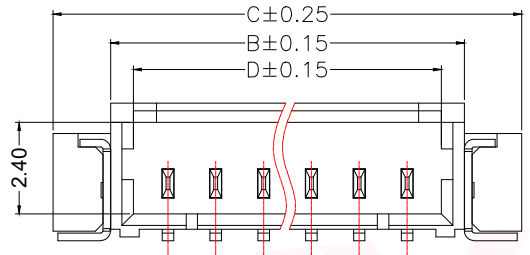

2P&3P

PIN	NO.	Dim A	Dim B	Dim C	Dim D
2	XY-MX1.25-2A61	1.25	4.45	7.45	3.05
3	XY-MX1.25-3A61	2.50	5.70	8.70	4.30
4	XY-MX1.25-4A61	3.75	6.95	9.95	5.55
5	XY-MX1.25-5A61	5.00	8.20	11.20	6.80
6	XY-MX1.25-6A61	6.25	9.45	12.45	8.05
7	XY-MX1.25-7A61	7.50	10.70	13.70	9.30
8	XY-MX1.25-8A61	8.75	11.95	14.95	10.55
9	XY-MX1.25-9A61	10.00	13.20	16.20	11.8
10	XY-MX1.25-10A61	11.25	14.45	17.45	13.05
11	XY-MX1.25-11A61	12.50	15.70	18.70	14.3
12	XY-MX1.25-12A61	13.75	16.95	19.95	15.55
13	XY-MX1.25-13A61	15.00	18.20	21.20	16.80
14	XY-MX1.25-14A61	16.25	19.45	22.45	18.05
15	XY-MX1.25-15A61	17.50	20.70	23.70	19.3
16	XY-MX1.25-16A61	18.75	21.95	24.95	20.55

DIMENSION IN mm		厦门市辛译精密电子有限公司 Xiamen XinYi Xyecomm Electronics Co.,Ltd		
TOLERANCE UNLESS OTHERWISE SPECIFIED		APR. Alex	TITLE: WAFER 1.25mm H3.6mm W/ B 90°SMT	
.X±0.35	.X*± 5°	CHK. Jack	DWG NO. XY-MX1.25-NA61	
.XX±0.25	.X*± 3°	DRA. Can	PROJECT:  CUSTOMER DRAWING	
.XXX±0.15	.XX*± 1°	SIZE A4	SCALE 1:1	SHEET 1/3 REV. A

REV.	Q'TY	ECN. NO.	APR.	DATE

PRELIMINARY  
DESIGN IS SUBJECT  
TO CHANGE WITHOUT  
PRIOR NOTICE

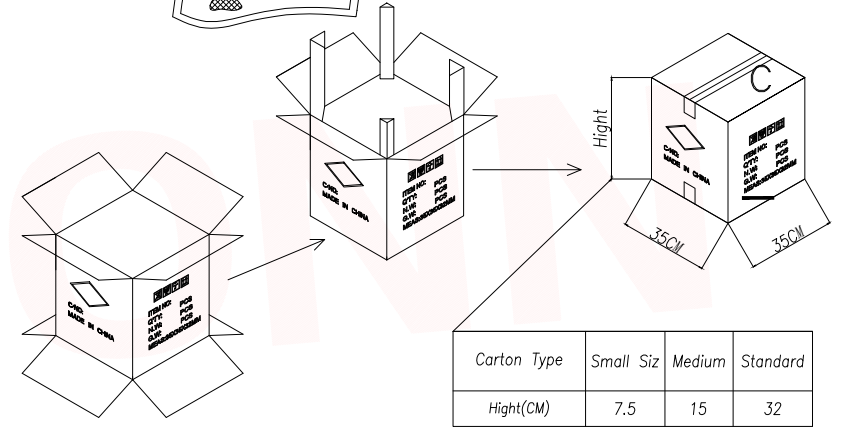
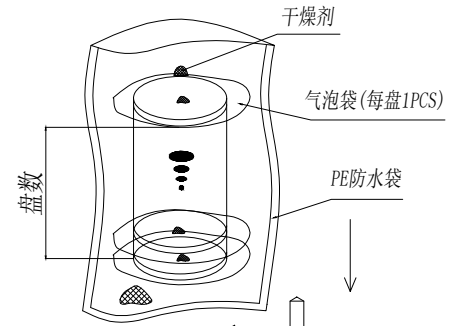
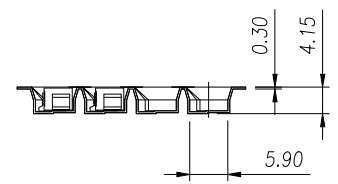
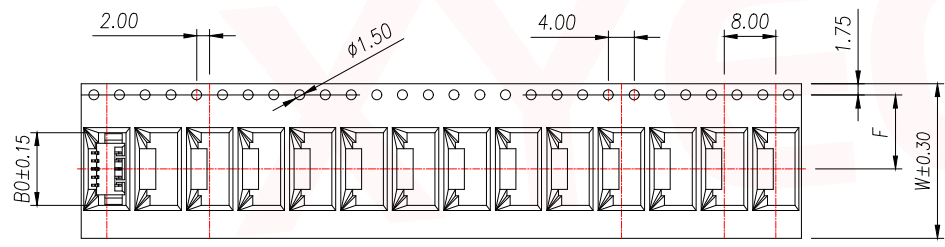
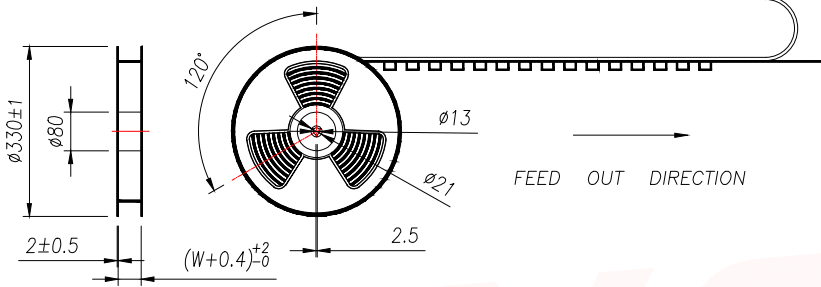
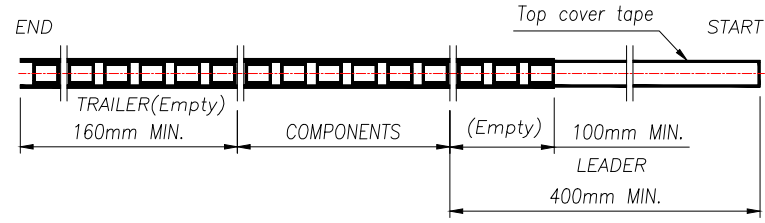

Carton Type	Small Siz	Medium	Standard
Hight(CM)	7.5	15	32

- NOTE:
- 1.10 SPROCKET HOLE PITCH CUMULATIVE TOLERANCE  $\pm 0.2$ mm.
  - 2.CARRIER CAMBER NOT TO EXCEED 1mm IN 100mm.
  - 3.ALL DIMENSIONS MEET EIA-481 REQUIREMENTS.
  - 4.MATERIAL: CLEAR ANTISTATIC PS, COLD SEALING.
  - 5.THICKNESS:  $0.30 \pm 0.05$ mm.
  - 6.PACKING LENGHT PER REEL: 16.5 METERS.
  - 7.COMPONENT LOAD PER REEL: 2000 PCS.

PIN	NO.	Dim B0	Dim W	Dim F	PCS/RELL	RELL/CARTON	PCS/CARTON
2	XY-MX1.25-2A61	7.55	16	7.5	2000	14	28000
3	XY-MX1.25-3A61	8.80					
4	XY-MX1.25-4A61	10.05	24	11.50		10	20000
5	XY-MX1.25-5A61	11.30					
6	XY-MX1.25-6A61	12.55					
7	XY-MX1.25-7A61	13.80					
8	XY-MX1.25-8A61	15.05					

DIMENSION IN mm		厦门市辛译精密电子有限公司 Xiamen XinYi Xyconn Electronics Co.,Ltd			
TOLERANCE UNLESS OTHERWISE SPECIFIED		APR.	Alex	TITLE: WAFER 1.25mm H3.6mm W/ B 90°SMT	
.X $\pm$ 0.35	X.* $\pm$ 5*	CHK.	Jack	DWG NO. XY-MX1.25-NA61	
.XX $\pm$ 0.25	.X* $\pm$ 3*	PROJ.		CUSTOMER DRAWING	
.XXX $\pm$ 0.15	.XX* $\pm$ 1*	DRA.	Can	SIZE A4	SCALE 1:1
		SHEET	2/3	REV.	A

REV.	Q'TY	ECN. NO.	APR.	DATE

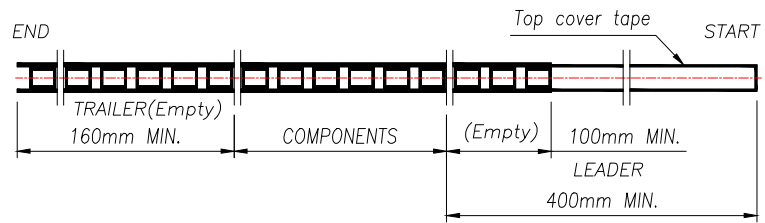

PRELIMINARY DESIGN IS SUBJECT TO CHANGE WITHOUT PRIOR NOTICE

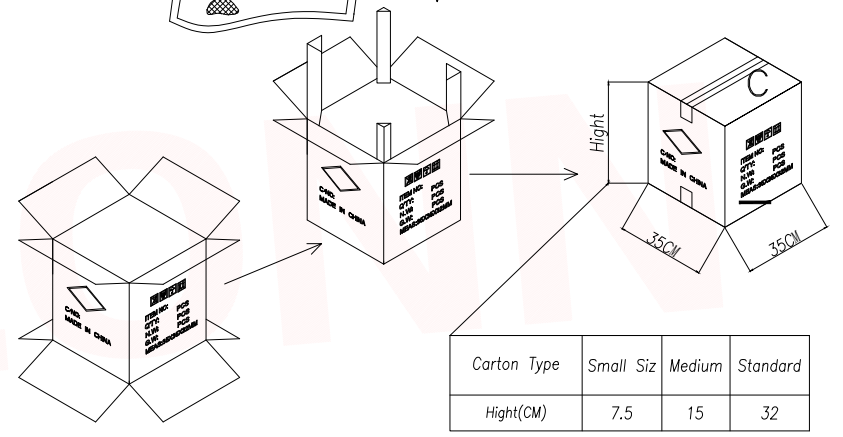
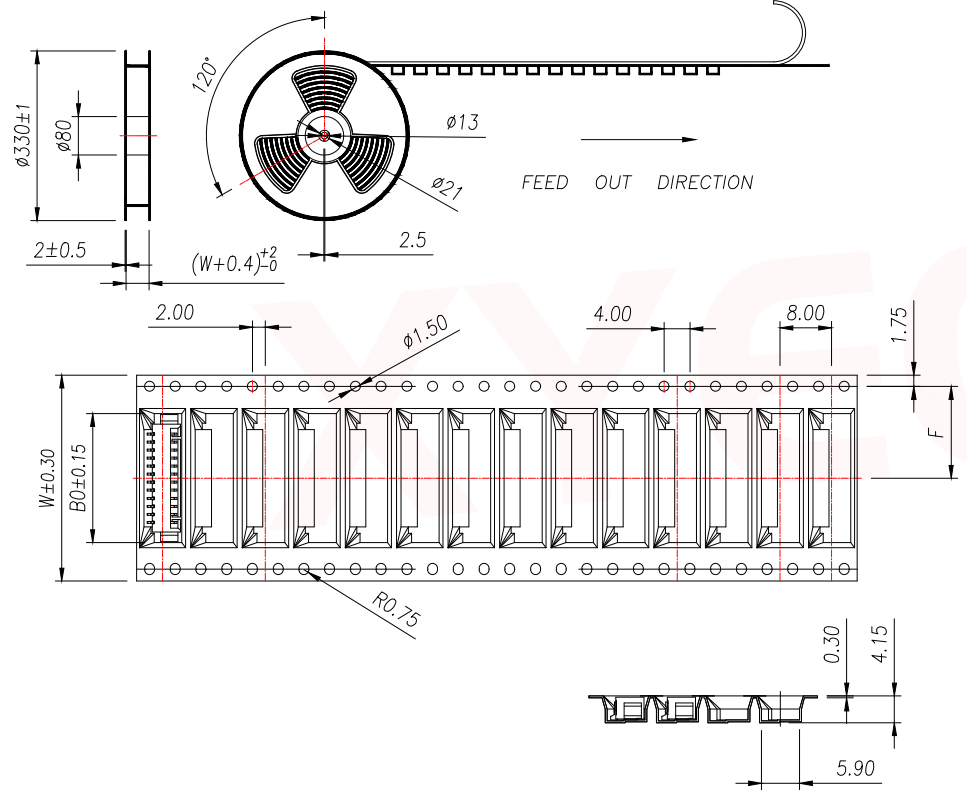
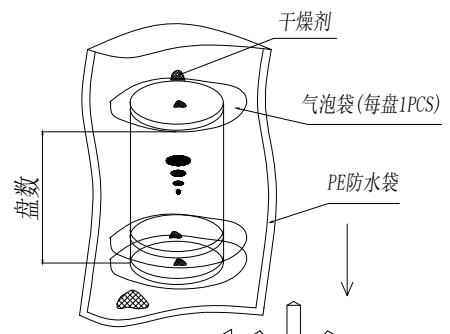

Carton Type	Small Siz	Medium	Standard
Hight(CM)	7.5	15	32

- NOTE:
- 1.10 SPROCKET HOLE PITCH CUMULATIVE TOLERANCE  $\pm 0.2\text{mm}$ .
  - 2.CARRIER CAMBER NOT TO EXCEED 1mm IN 100mm.
  - 3.ALL DIMENSIONS MEET EIA-481 REQUIREMENTS.
  - 4.MATERIAL: CLEAR ANTISTATIC PS, COLD SEALING.
  - 5.THICKNESS:  $0.30 \pm 0.05\text{mm}$ .
  - 6.PACKING LENGTH PER REEL: 16.5 METERS.
  - 7.COMPONENT LOAD PER REEL: 2000 PCS.

PIN	NO.	Dim B0	Dim W	Dim F	PCS/RELL	RELL/CARTON	PCS/CARTON
9	XY-MX1.25-9A61	16.30	32	14.2	2000	8	16000
10	XY-MX1.25-10A61	17.55					
11	XY-MX1.25-11A61	18.80					
12	XY-MX1.25-12A61	20.05					
13	XY-MX1.25-13A61	21.30	44	20.2	6	12000	
14	XY-MX1.25-14A61	22.55					
15	XY-MX1.25-15A61	23.80					
16	XY-MX1.25-16A61	25.05					

DIMENSION IN mm		厦门市辛译精密电子有限公司 Xiamen XinYi Xyconn Electronics Co.,Ltd	
TOLERANCE UNLESS OTHERWISE SPECIFIED			
.X $\pm$ 0.35	X.* $\pm$ 5*	APR. Alex	TITLE: WAFER 1.25mm H3.6mm W/ B 90°SMT
.XX $\pm$ 0.25	.X* $\pm$ 3*	CHK. Jack	DWG NO. XY-MX1.25-NA61
.XXX $\pm$ 0.15	.XX* $\pm$ 1*	DRA. Can	PROJ.  CUSTOMER DRAWING
SIZE A4	SCALE 1:1	SHEET 3/3	REV. A

## X-ON Electronics

Largest Supplier of Electrical and Electronic Components

*Click to view similar products for [Headers & Wire Housings](#) category:*

*Click to view products by [XYECONN](#) manufacturer:*

Other Similar products are found below :

[0015917161](#) [0022155065](#) [57102-F02-18ULF](#) [58102-G61-06LF](#) [582553-1](#) [01.001.5753.1](#) [0050291907](#) [02.125.8002.8](#) [609-3404](#) [61062-3](#)  
[CSU011177004](#) [622-0430](#) [622-3653LF](#) [63453-116](#) [636-1030](#) [636-1427](#) [636-3427](#) [636-4007](#) [641938-9](#) [65495-038](#) [65692-001LF](#) [65781-018](#)  
[65781-047](#) [65817-010LF](#) [65817-015LF](#) [67095-007LF](#) [67601157](#) [68631-112](#) [68645-018](#) [699319-000](#) [70.362.1628.0](#) [70-4210](#) [70-4226B](#) [70-](#)  
[4853B](#) [71.350.2428.0](#) [733-134](#) [733-162](#) [MHR-64-VUAL](#) [80.063.4001.1](#) [800-90-001-10-001000](#) [801-43-002-10-013000](#) [801-43-006-10-](#)  
[002000](#) [803-43-024-10-001000](#) [803-93-012-10-001000](#) [8-1437020-4](#) [819-22-004-30-001101](#) [820-22-006-30-001101](#) [820-22-008-30-001101](#)  
[821-22-002-10-001101](#) [821-22-003-10-002101](#)