

REV.	Q'TY	ECN. NO.	APR.	DATE

PRELIMINARY  
DESIGN IS SUBJECT  
TO CHANGE WITHOUT  
PRIOR NOTICE

NOTES:

- Working temp:-25°C~85°C.
- Voltage rating:50V AC/DC(rms)
- Contact resistance:40mΩ max.
- Insulation resistance:100MΩ min.
- Current rating:1A AV/DC
- Withstanding Voltage:500V AC/minute
- Pin Retention Force:3N min.
- Housing material:LCP UL94-V0,Natural
- Terminal materl:Brass,  
plating Ni 40u" min , plating Tin 100u"min.
- Solder tab material:Brass,  
plating Ni 40u" min , plating Tin 100u"min.

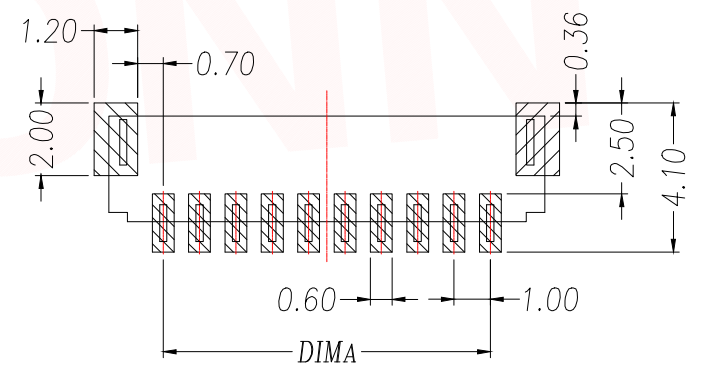
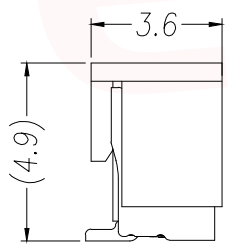
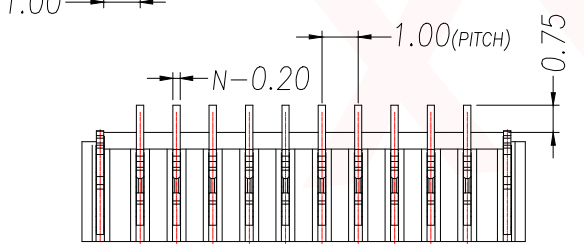
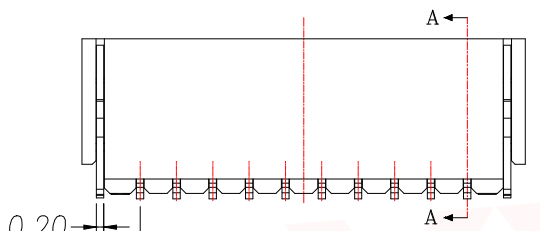
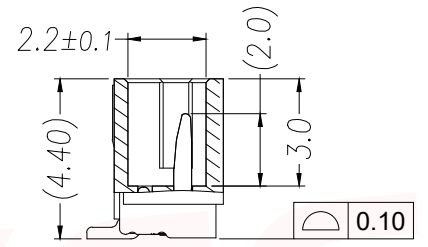
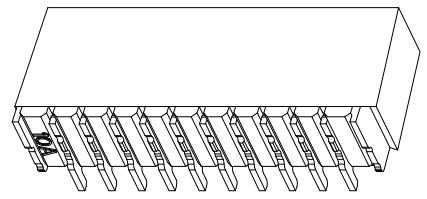
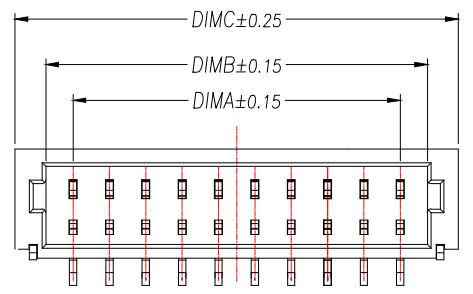

RECOMMENDED PCB LAYOUT TOP VIEW (TOLERANCE:±0.05)

SMT SOLDER AREA

PIN	NO.	Dim A	Dim B	Dim C
2	XY-SH1.0-2A51	1.00	2.50	4.20
3	XY-SH1.0-3A51	2.00	3.50	5.20
4	XY-SH1.0-4A51	3.00	4.50	6.20
5	XY-SH1.0-5A51	4.00	5.50	7.20
6	XY-SH1.0-6A51	5.00	6.50	8.20
7	XY-SH1.0-7A51	6.00	7.50	9.20
8	XY-SH1.0-8A51	7.00	8.50	10.20
9	XY-SH1.0-9A51	8.00	9.50	11.20
10	XY-SH1.0-10A51	9.00	10.50	12.20
11	XY-SH1.0-11A51	10.00	11.50	13.20
12	XY-SH1.0-12A51	11.00	12.50	14.20
13	XY-SH1.0-13A51	12.00	13.50	15.20
14	XY-SH1.0-14A51	13.00	14.50	16.20
15	XY-SH1.0-15A51	14.00	15.50	17.20
16	XY-SH1.0-16A51	15.00	16.50	18.20

DIMENSION IN mm		厦门市辛译精密电子有限公司 Xiamen XinYi Xyconn Electronics Co.,Ltd		
TOLERANCE UNLESS OTHERWISE SPECIFIED				
.X±0.35	X.*± 5°	APR. Alex	TITLE: WAFER 1.00mm H4.4mm 180°SMT	
.XX±0.25	.X*± 3°	CHK. Jack	DWG NO. XY-SH1.0-NA51	
.XXX±0.15	.XX*± 1°	DRA. Can	CUSTOMER DRAWING	
SIZE A4	SCALE 1:1	SHEET 1/3	REV. A	

REV.	Q'TY	ECN. NO.	APR.	DATE

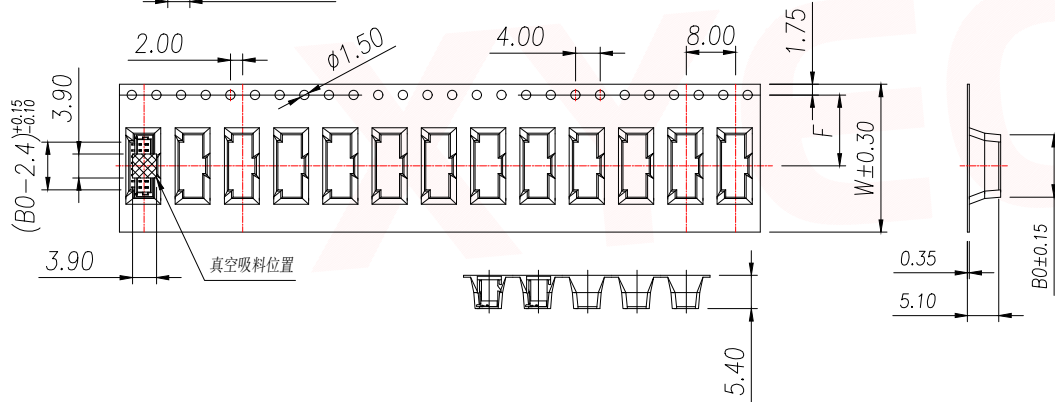
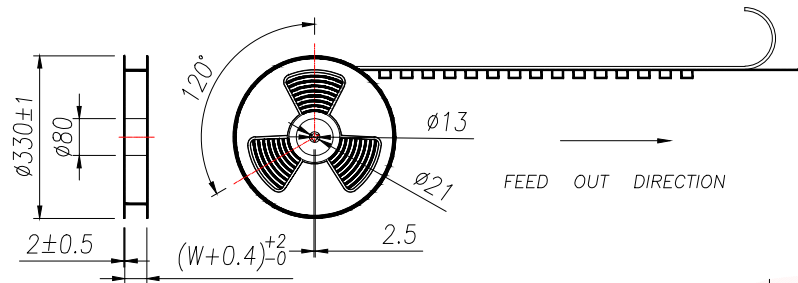
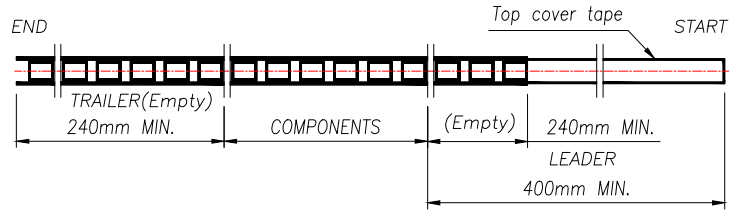

PRELIMINARY DESIGN IS SUBJECT TO CHANGE WITHOUT PRIOR NOTICE

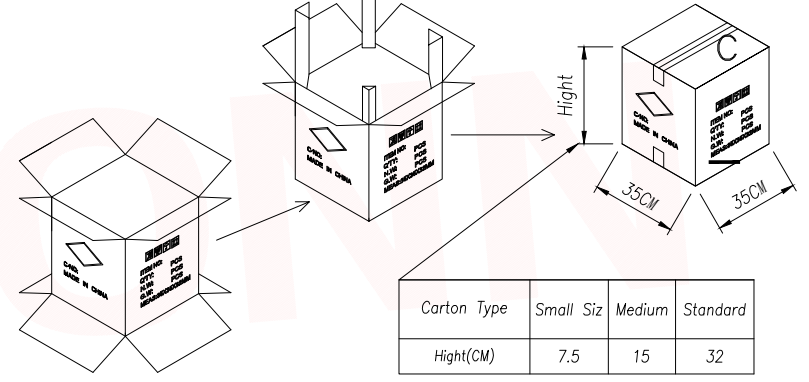
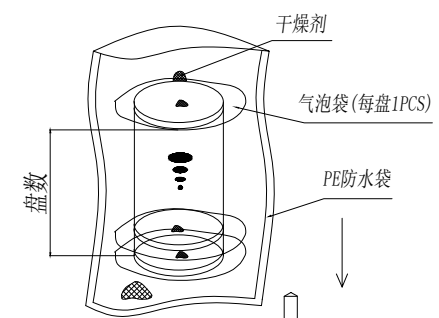

Carton Type	Small Siz	Medium	Standard
Height(CM)	7.5	15	32

- NOTE:
- 1.10 SPROCKET HOLE PITCH CUMULATIVE TOLERANCE  $\pm 0.2\text{mm}$ .
  - 2.CARRIER CAMBER NOT TO EXCEED 1mm IN 100mm.
  - 3.ALL DIMENSIONS MEET EIA-481 REQUIREMENTS.
  - 4.MATERIAL: CLEAR ANTISTATIC PS. COLD SEALING.
  - 5.COMPONENT LOAD PER REEL: 1500 PCS.

PIN	NO.	B0	Dim W	Dim F	PCS/REEL	REEL/CARTON	PCS/CARTON
2	XY-SH1.0-2A51	4.15	16	7.50	1500	14	21000
3	XY-SH1.0-3A51	5.15					
4	XY-SH1.0-4A51	6.15					
5	XY-SH1.0-5A51	7.15					
6	XY-SH1.0-6A51	8.15					
7	XY-SH1.0-7A51	9.15	24	11.50	15000	10	
8	XY-SH1.0-8A51	10.15					
09	XY-SH1.0-9A51	11.15					
10	XY-SH1.0-10A51	12.15					
11	XY-SH1.0-11A51	13.15					
12	XY-SH1.0-12A51	14.15					
13	XY-SH1.0-13A51	15.15					

DIMENSION IN mm		厦门市辛译精密电子有限公司 Xiamen XinYi Xyconn Electronics Co.,Ltd			
TOLERANCE UNLESS OTHERWISE SPECIFIED		APR.	Alex	TITLE: WAFER 1.00mm H4.4mm 180°SMT	
.X $\pm$ 0.35	X.* $\pm$ 5*	CHK.	Jack	DWG NO. XY-SH1.0-NA51	
.XX $\pm$ 0.25	.X* $\pm$ 3*	DRA.	Can	PROJ.  CUSTOMER DRAWING	
.XXX $\pm$ 0.15	.XX* $\pm$ 1*	SIZE	A4	SCALE	1:1
		SHEET	2/3	REV.	A

REV.	Q'TY	ECN. NO.	APR.	DATE

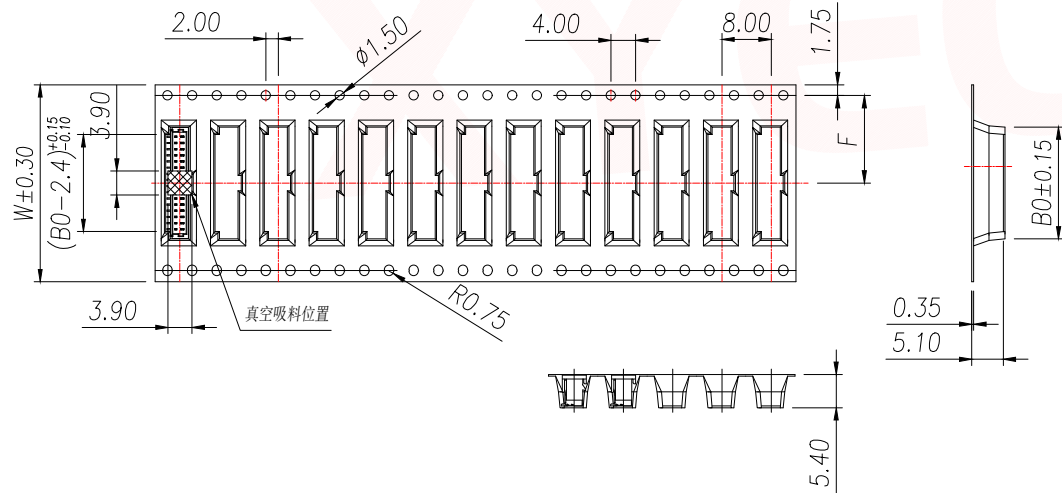
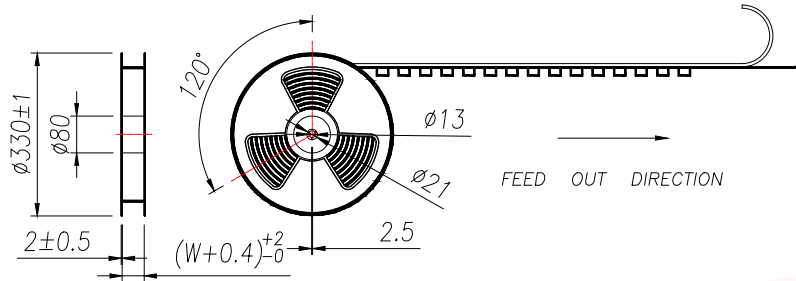
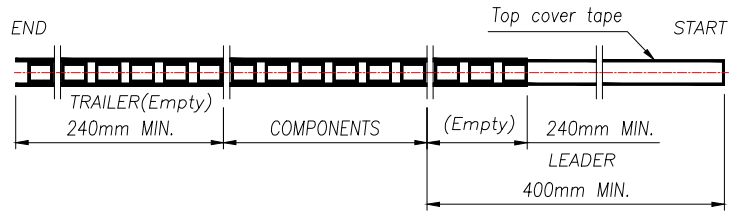

PRELIMINARY  
DESIGN IS SUBJECT  
TO CHANGE WITHOUT  
PRIOR NOTICE

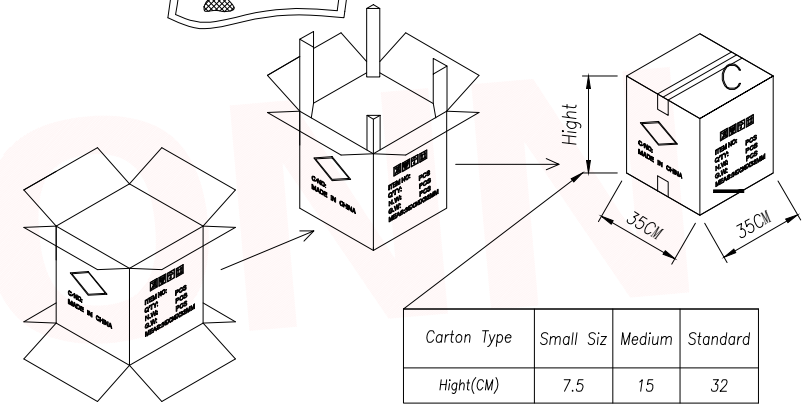
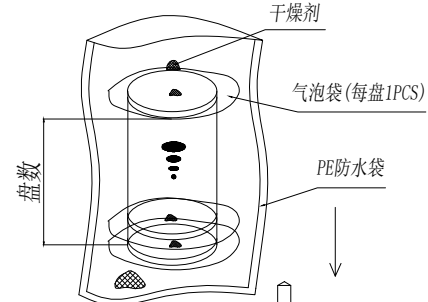

NOTE:  
1.10 SPROCKET HOLE PITCH CUMULATIVE TOLERANCE  $\pm 0.2$ mm.  
2.CARRIER CAMBER NOT TO EXCEED 1mm IN 100mm.  
3.ALL DIMENSIONS MEET EIA-481 REQUIREMENTS.  
4.MATERIAL: CLEAR ANTISTATIC PS, GOLD SEALING.  
5.COMPONENT LOAD PER REEL: 1500 PCS.

PIN	NO.	B0	Dim W	Dim F	PCS/REEL	REEL/CARTON	PCS/CARTON
14	XY-SH1.0-14A51	16.15	32	14.2	1500	8	12000
15	XY-SH1.0-15A51	17.15					
16	XY-SH1.0-16A51	18.15					

DIMENSION IN mm		厦门市辛译精密电子有限公司 Xiamen XinYi Xyconn Electronics Co.,Ltd			
TOLERANCE UNLESS OTHERWISE SPECIFIED		APR.	Alex	TITLE: WAFER 1.00mm H4.4mm 180°SMT	
.XX $\pm 0.25$	.X* $\pm 3^\circ$	CHK.	Jack	DWG NO. XY-SH1.0-NA51	
.XXX $\pm 0.15$	.XX* $\pm 1^\circ$	DRA.	Can	PROJ.  CUSTOMER DRAWING	
		SIZE	A4	SCALE	1:1
		SHEET	3/3	REV.	A

## X-ON Electronics

Largest Supplier of Electrical and Electronic Components

*Click to view similar products for [Headers & Wire Housings](#) category:*

*Click to view products by [XYECONN](#) manufacturer:*

Other Similar products are found below :

[0015917161](#) [0022155065](#) [57102-F02-18ULF](#) [58102-G61-06LF](#) [582553-1](#) [01.001.5753.1](#) [0050291907](#) [02.125.8002.8](#) [609-3404](#) [61062-3](#)  
[CSU011177004](#) [622-0430](#) [622-3653LF](#) [63453-116](#) [636-1030](#) [636-1427](#) [636-3427](#) [636-4007](#) [641938-9](#) [65495-038](#) [65692-001LF](#) [65781-018](#)  
[65781-047](#) [65817-010LF](#) [65817-015LF](#) [67095-007LF](#) [67601157](#) [68631-112](#) [68645-018](#) [699319-000](#) [70.362.1628.0](#) [70-4210](#) [70-4226B](#) [70-](#)  
[4853B](#) [71.350.2428.0](#) [733-134](#) [733-162](#) [760-3052](#) [MHR-64-VUAL](#) [80.063.4001.1](#) [800-90-001-10-001000](#) [801-43-002-10-013000](#)  
[801-43-006-10-002000](#) [803-43-024-10-001000](#) [803-93-012-10-001000](#) [8-1437020-4](#) [819-22-004-30-001101](#) [820-22-006-30-001101](#)  
[820-22-008-30-001101](#) [821-22-002-10-001101](#)