

REV.	Q'TY	ECN. NO.	APR.	DATE

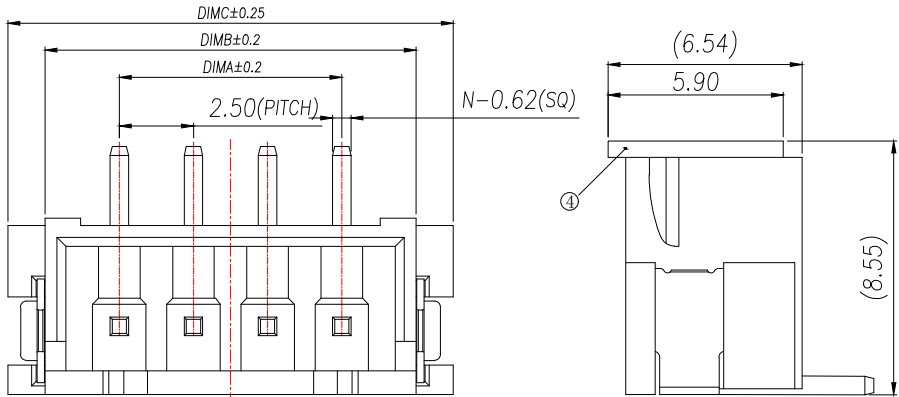

PRELIMINARY  
DESIGN IS SUBJECT  
TO CHANGE WITHOUT  
PRIOR NOTICE

- NOTES:
- Working temp:-25°C~85°C.
  - Voltage rating:250V AV/DC(rms)
  - Contact resistance:20mΩ max.
  - Insulation resistance:1000MΩ min.
  - Current rating:3A AV/DC
  - Withstanding Voltage:1000V AC/minute
  - Pin Retention Force:15N min.
  - Housing material:LCP UL94-V0,Natural
  - Terminal materl:Brass,  
plating Ni 50u" min , plating Tin 100u"min.
  - Solder tab material:Brass,  
plating Ni 50u" min , plating Tin 100u"min.

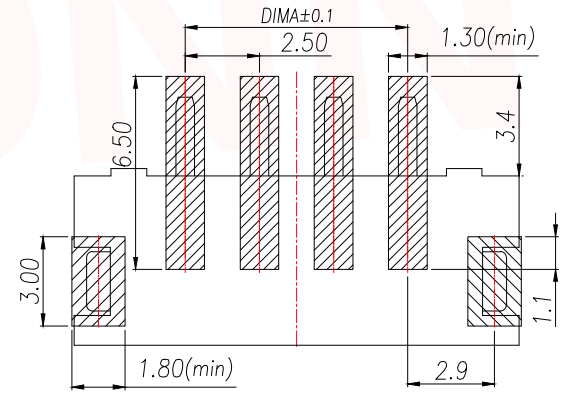
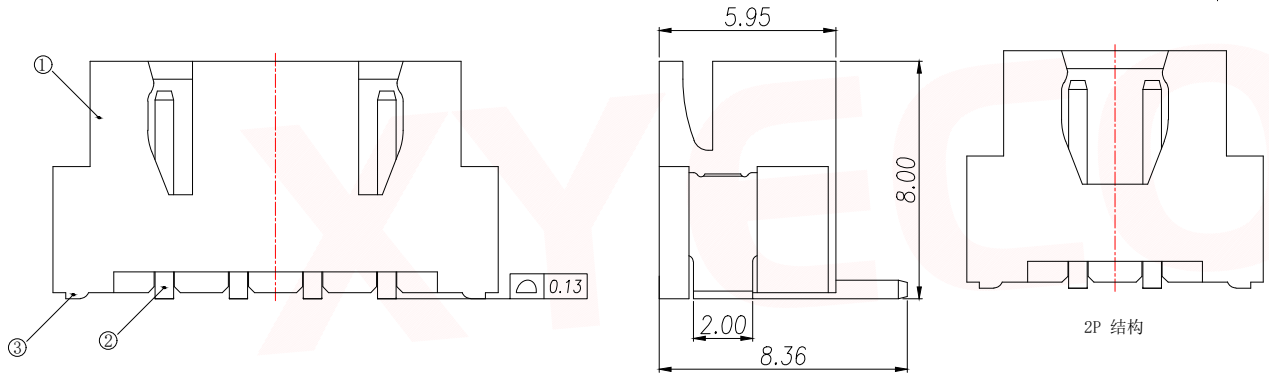

RECOMMENDED PCB LAYOUT TOP VIEW (TOLERANCE:±0.05)

SMT SOLDER AREA

PIN	NO.	Dim A	Dim B	Dim C
2	XY-XH2.5-1A51	2.50	7.50	10.00
3	XY-XH2.5-2A51	5.00	10.00	12.50
4	XY-XH2.5-3A51	7.50	12.50	15.00
5	XY-XH2.5-4A51	10.00	15.00	17.50
6	XY-XH2.5-5A51	12.50	17.50	20.00
7	XY-XH2.5-6A51	15.00	20.00	22.50
8	XY-XH2.5-7A51	17.50	22.50	25.00
9	XY-XH2.5-8A51	20.00	25.00	27.50
10	XY-XH2.5-9A51	22.50	27.50	30.00
11	XY-XH2.5-10A51	25.00	30.00	32.50
12	XY-XH2.5-11A51	27.50	32.50	35.00
13	XY-XH2.5-12A51	30.00	35.00	37.50
14	XY-XH2.5-13A51	32.50	37.50	40.00
15	XY-XH2.5-14A51	35.00	40.00	42.50
16	XY-XH2.5-15A51	37.50	42.50	45.00

DIMENSION IN mm		厦门市辛译精密电子有限公司 Xiamen XinYi Xyconn Electronics Co.,Ltd		
TOLERANCE UNLESS OTHERWISE SPECIFIED				
.X±0.35	X.*± 5°	APR. Alex	TITLE: WAFER 2.50mm H8.0mm(XH) 180°SMT	
.XX±0.25	.X.*± 3°	CHK. Jack	DWG NO. XY-XH2.5-NA51	
.XXX±0.15	.XX.*± 1°	DRA. Can	CUSTOMER DRAWING	
		SIZE A4	SCALE 1:1	SHEET 1/3
				REV. A

REV.	Q'TY	ECN. NO.	APR.	DATE

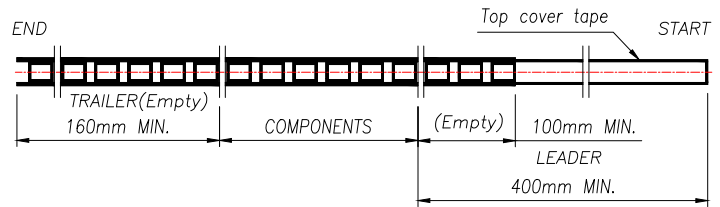

PRELIMINARY  
DESIGN IS SUBJECT  
TO CHANGE WITHOUT  
PRIOR NOTICE

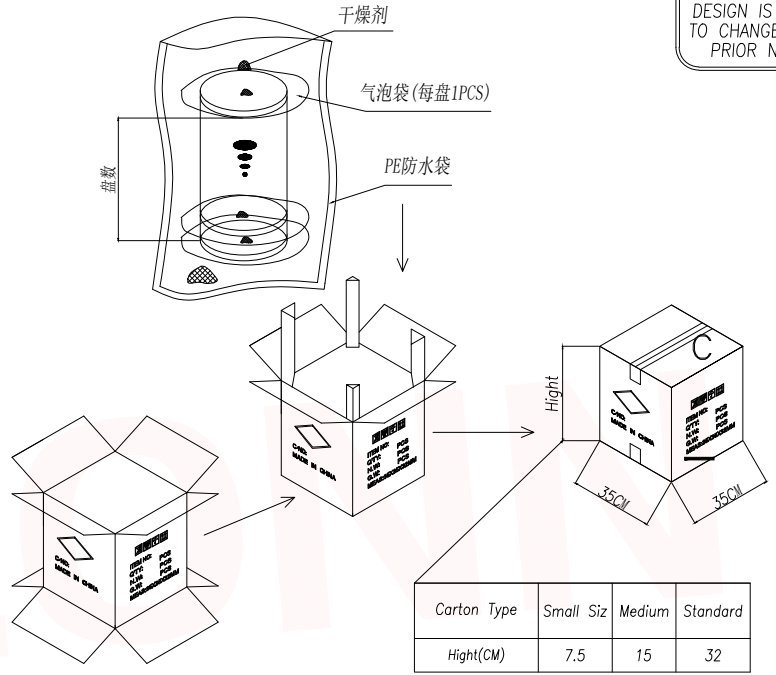
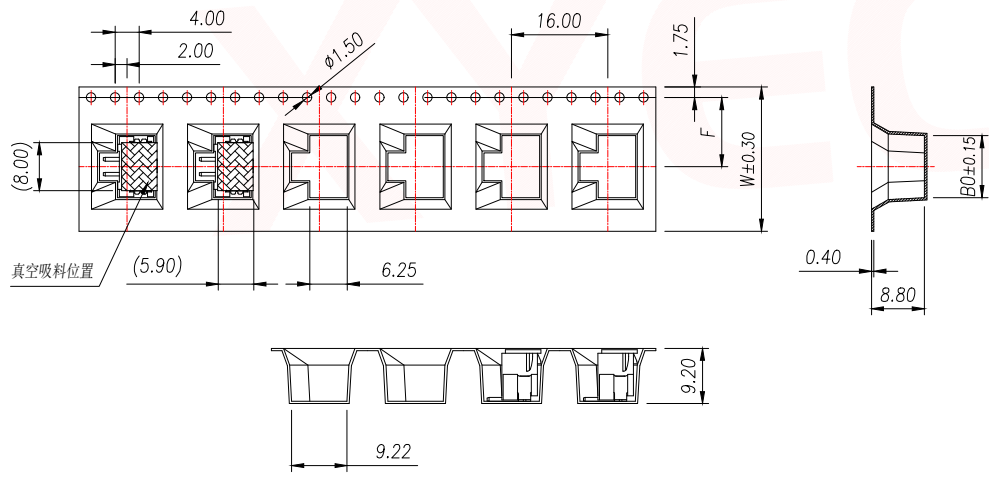
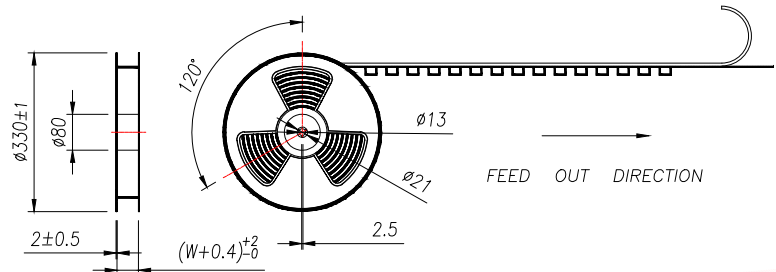

Carton Type	Small Siz	Medium	Standard
Hight(CM)	7.5	15	32

- NOTE:
- 1.10 SPROCKET HOLE PITCH CUMULATIVE TOLERANCE ±0.2mm.
  - 2.CARRIER CAMBER NOT TO EXCEED 1mm IN 100mm.
  - 3.ALL DIMENSIONS MEET EIA-481 REQUIREMENTS.
  - 4.MATERIAL: CLEAR ANTISTATIC PS, COLD SEALING.
  - 5.THICKNESS: 0.40±0.05mm.
  - 6.PACKING LENGTH PER REEL: 8.4 METERS.
  - 7.COMPONENT LOAD PER REEL: 500 PCS.

PIN	NO.	Dim B0	Dim W	Dim F	PCS/RELL	RELL/CARTON	PCS/CARTON
2	XY-XH2.5-2A51	10.30	24.00	11.50	500	10	5000
3	XY-XH2.5-3A51	12.80					
4	XY-XH2.5-4A51	15.30					

DIMENSION IN mm		厦门市辛译精密电子有限公司 Xiamen XinYi Xyconn Electronics Co.,Ltd			
TOLERANCE UNLESS OTHERWISE SPECIFIED					
.X±0.35	X.*± 5°	APR.	Alex	TITLE: WAFER 2.50mm H8.0mm(XH) 180°SMT	
.XX±0.25	.X.*± 3°	CHK.	Jack	DWG NO. XY-XH2.5-NA51	
.XXX±0.15	.XX.*± 1°	DRA.	Can	PROJ.	CUSTOMER DRAWING
		SIZE A4	SCALE 1:1	SHEET 2/3	REV. A

REV.	Q'TY	ECN. NO.	APR.	DATE

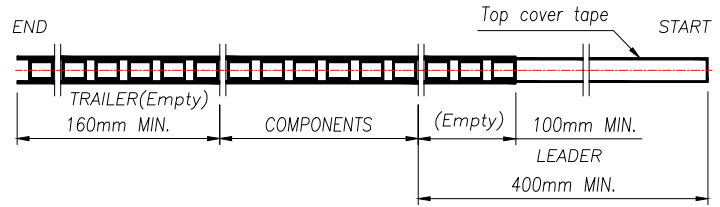

PRELIMINARY DESIGN IS SUBJECT TO CHANGE WITHOUT PRIOR NOTICE

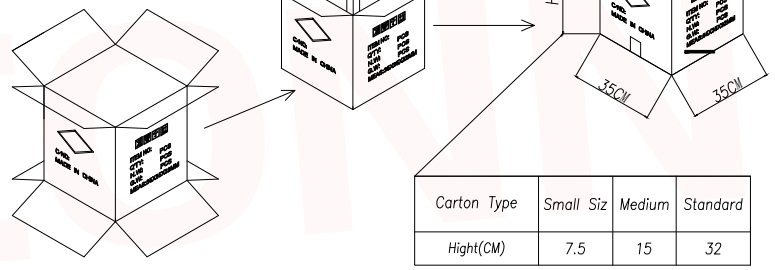
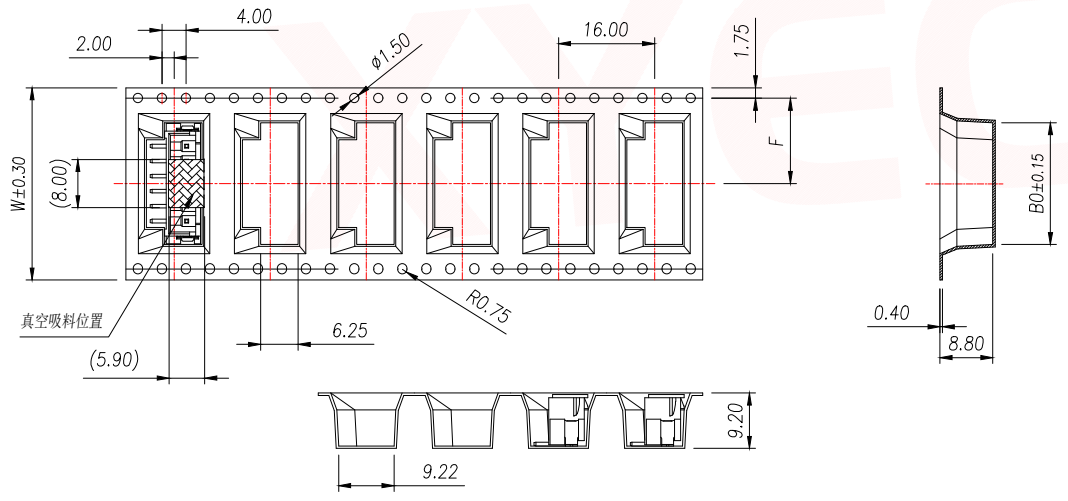
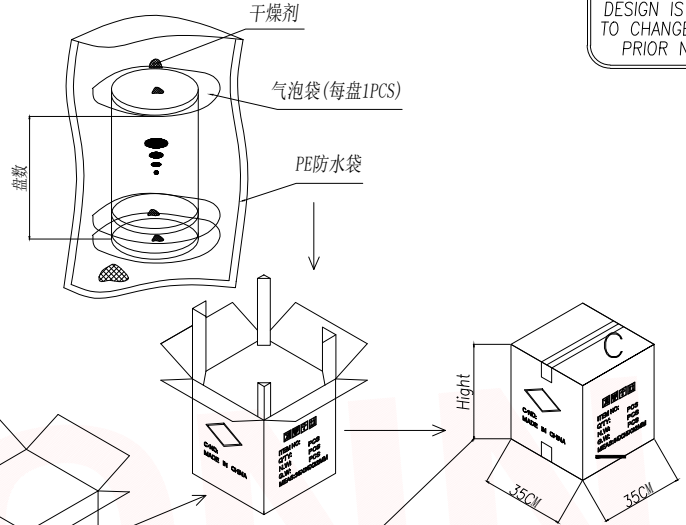
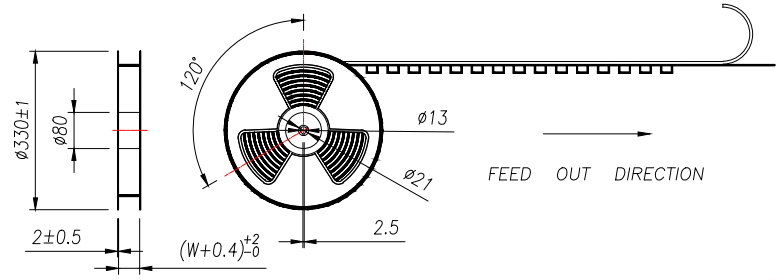

Carton Type	Small Siz	Medium	Standard
Hight(CM)	7.5	15	32

- NOTE:
- 1.10 SPROCKET HOLE PITCH CUMULATIVE TOLERANCE ±0.2mm.
  - 2.CARRIER CAMBER NOT TO EXCEED 1mm IN 100mm.
  - 3.ALL DIMENSIONS MEET EIA-481 REQUIREMENTS.
  - 4.MATERIAL: CLEAR ANTISTATIC PS. COLD SEALING.
  - 5.THICKNESS: 0.40±0.05mm.
  - 6.PACKING LENGTH PER REEL: 8.4 METERS.
  - 7.COMPONENT LOAD PER REEL: 500 PCS.

PIN	NO.	Dim B0	Dim W	Dim F	PCS/RELL	RELL/CARTON	PCS/CARTON
5	XY-XH2.5-5A51	17.80	32	14.2	500	8	4000
6	XY-XH2.5-6A51	20.30					
7	XY-XH2.5-7A51	22.80					
8	XY-XH2.5-8A51	25.30	44	20.2	500	6	3000
9	XY-XH2.5-9A51	27.80					
10	XY-XH2.5-10A51	30.30	56	26.2	500	5	2500
11	XY-XH2.5-11A51	32.80					
12	XY-XH2.5-12A51	35.30					

DIMENSION IN mm		厦门市辛译精密电子有限公司 Xiamen XinYi Xyconn Electronics Co.,Ltd			
TOLERANCE UNLESS OTHERWISE SPECIFIED					
.X±0.35	X.*±5°	APR.	Alex	TITLE: WAFER 2.50mm H8.0mm(XH) 180°SMT	
.XX±0.25	.X.*±3°	CHK.	Jack	DWG NO. XY-XH2.5-NA51	
.XXX±0.15	.XX.*±1°	DRA.	Can	PROJ.  CUSTOMER DRAWING	
		SIZE A4	SCALE 1:1	SHEET 3/3	REV. A

## X-ON Electronics

Largest Supplier of Electrical and Electronic Components

*Click to view similar products for [Headers & Wire Housings](#) category:*

*Click to view products by [XYECONN](#) manufacturer:*

Other Similar products are found below :

[0015917161](#) [0022155065](#) [57102-F02-18ULF](#) [58102-G61-06LF](#) [582553-1](#) [01.001.5753.1](#) [0050291907](#) [02.125.8002.8](#) [609-3404](#) [61062-3](#)  
[CSU011177004](#) [622-0430](#) [622-3653LF](#) [63453-116](#) [636-1030](#) [636-1427](#) [636-3427](#) [636-4007](#) [641938-9](#) [65495-038](#) [65692-001LF](#) [65781-018](#)  
[65781-047](#) [65817-010LF](#) [65817-015LF](#) [67095-007LF](#) [67601157](#) [68631-112](#) [68645-018](#) [699319-000](#) [70.362.1628.0](#) [70-4210](#) [70-4226B](#) [70-](#)  
[4853B](#) [71.350.2428.0](#) [733-134](#) [733-162](#) [760-3052](#) [MHR-64-VUAL](#) [80.063.4001.1](#) [800-90-001-10-001000](#) [801-43-002-10-013000](#)  
[801-43-006-10-002000](#) [803-43-024-10-001000](#) [803-93-012-10-001000](#) [8-1437020-4](#) [819-22-004-30-001101](#) [820-22-006-30-001101](#)  
[820-22-008-30-001101](#) [821-22-002-10-001101](#)