

REV.	Q'TY	ECN. NO.	APR.	DATE

Technical Index:

1. Temperature range: $-25^{\circ}\text{C}\sim 85^{\circ}\text{C}$.
2. Rated voltage: 250V DC/AC(rms).
3. Rated current: 3.0A.
4. Contact resistance: $\leq 20\text{m}\Omega$.
5. Withstanding voltage: 1000V AC/minute.
6. Insulation resistance: $\geq 1000\text{M}\Omega$.

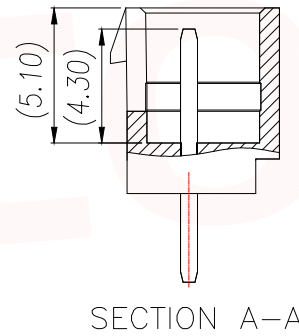
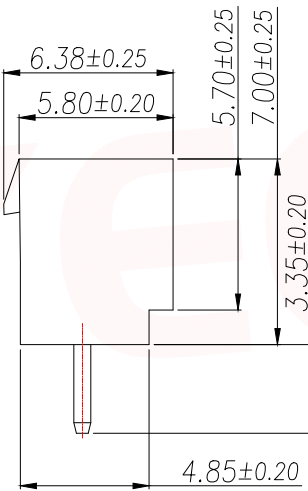
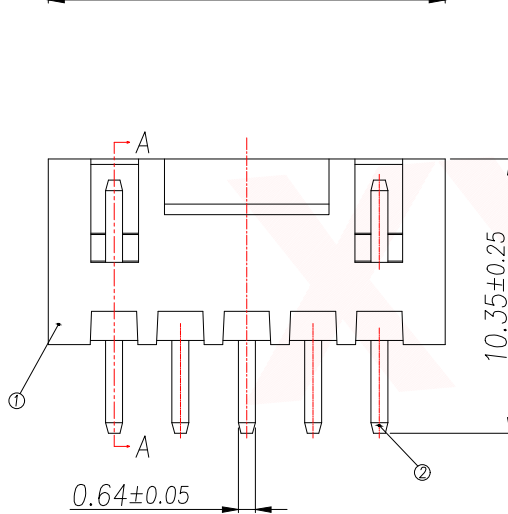
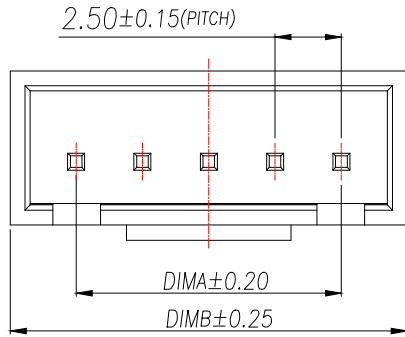

Part No	Pin	A	B
XY-XHB2.54-2A11-YT	2	2.5	7.5
XY-XHB2.54-3A11-YT	3	5.0	10.0
XY-XHB2.54-4A11-YT	4	7.5	12.5
XY-XHB2.54-5A11-YT	5	10.0	15.0
XY-XHB2.54-6A11-YT	6	12.5	17.5
XY-XHB2.54-7A11-YT	7	15.0	20.0
XY-XHB2.54-8A11-YT	8	17.5	22.5
XY-XHB2.54-9A11-YT	9	20.0	25.0
XY-XHB2.54-10A11-YT	10	22.5	27.5
XY-XHB2.54-11A11-YT	11	25.0	30.0
XY-XHB2.54-12A11-YT	12	27.5	32.5
XY-XHB2.54-13A11-YT	13	30.0	35.0
XY-XHB2.54-14A11-YT	14	32.5	37.5
XY-XHB2.54-15A11-YT	15	35.0	40.0
XY-XHB2.54-16A11-YT	16	37.5	42.5
XY-XHB2.54-17A11-YT	17	40.0	45.0

序号	品名	材质
1	基座Wafer	PA66 UL94V-2 黄色
2	端子Contact	铜合金/镀锡

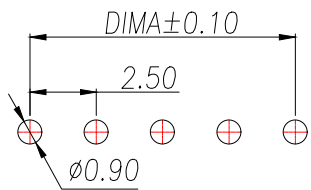

适用线路板(PCB LAYOUT)

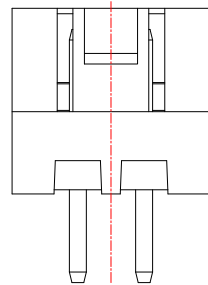

2PiN

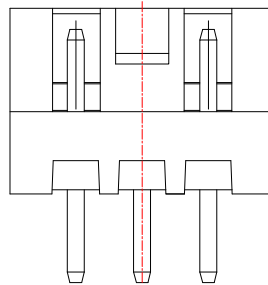

3PiN

DIMENSION IN mm		厦门市辛译精密电子有限公司 Xiamen XinYi Xyconn Electronics Co.,Ltd			
TOLERANCE UNLESS OTHERWISE SPECIFIED		APR.	CHK.	DRA.	TITLE:
.X±0.35	X.*±5°	Alex	Jack	Can	WAFER 2.54 180° DIP 黄色 带扣
.XX±0.25	.X.*±3°				DWG NO. XY-XHB2.54-NA11-YT
.XXX±0.15	.XX.*±1°				PROJ. CUSTOMER DRAWING
		SIZE A4	SCALE 1:1	SHEET 1/1	REV. A

X-ON Electronics

Largest Supplier of Electrical and Electronic Components

Click to view similar products for [Headers & Wire Housings](#) category:

Click to view products by [XYECONN](#) manufacturer:

Other Similar products are found below :

[0015917161](#) [0022155065](#) [57102-F02-18ULF](#) [58102-G61-06LF](#) [582553-1](#) [01.001.5753.1](#) [0050291907](#) [02.125.8002.8](#) [609-3404](#) [61062-3](#)
[CSU011177004](#) [622-0430](#) [622-3653LF](#) [63453-116](#) [636-1030](#) [636-1427](#) [636-3427](#) [636-4007](#) [641938-9](#) [65495-038](#) [65692-001LF](#) [65781-018](#)
[65781-047](#) [65817-010LF](#) [65817-015LF](#) [67095-007LF](#) [67601157](#) [68631-112](#) [68645-018](#) [699319-000](#) [70.362.1628.0](#) [70-4210](#) [70-4226B](#) [70-](#)
[4853B](#) [71.350.2428.0](#) [733-134](#) [733-162](#) [760-3052](#) [MHR-64-VUAL](#) [80.063.4001.1](#) [800-90-001-10-001000](#) [801-43-002-10-013000](#)
[801-43-006-10-002000](#) [803-43-024-10-001000](#) [803-93-012-10-001000](#) [8-1437020-4](#) [819-22-004-30-001101](#) [820-22-006-30-001101](#)
[820-22-008-30-001101](#) [821-22-002-10-001101](#)