

单节锂离子/锂聚合物可充电电池组保护芯片

概述

XB5352G 产品 是单节锂离子/锂聚合物可充电电池组保护的高集成度解决方案。XB5352G 包括了先进的功率 MOSFET, 高精度的电压检测电路和延时电路。

XB5352G 使用 SOT23-5 封装和只有一个外部器件, 使电池的保护电路空间最小化。这使得该器件非常适合应用于空间限制得非常小的可充电电池组应用。

XB5352G 具有过充, 过放, 过流, 过温 及短路等所有的电池所需保护功能, 并且工作时功耗非常低。

该芯片不仅仅是为手机而设计, 也适用于一切需要锂离子或锂聚合物可充电电池 长时间供电的各种信息产品的应用场合, 如智能手环、手表、蓝牙耳机等产品。

应用

单节锂离子电池

聚合物锂电池

特性

- 充电器反向连接保护
 - 电池反向连接保护
 - 集成等效 45 mΩ 的先进的功率 MOSFET
 - SOT23-5 封装
 - 只有一个外部电容器
 - 过温保护
 - 过充电流保护
 - 2 段过流保护
 - 过放电流 1
 - 负载短路电流
 - 充电器检测功能
 - 0V 电池充电功能
 - 延时时间内部设定
 - 高精度电压检测
 - 低静态耗电流
- 工作状态: 2.8uA 典型值.. 过放模式下: 1.5uA 典型值.
- 兼容 RoHS 和无铅标准.

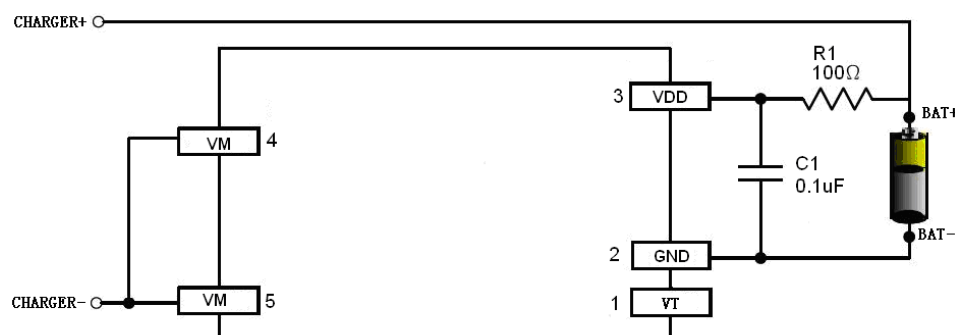

图一、典型应用电路

订货信息

| 产品型号 | 封装 | 过充电压 [V _{CU}] (V) | 过充恢复电压 [V _{CL}] (V) | 过放电压 [V _{DL}] (V) | 过放恢复电压 [V _{DR}] (V) | 过流检测电流 [I _{OV1}] (A) | 丝印 |
|---------|---------|--------------------------------|----------------------------------|--------------------------------|----------------------------------|-----------------------------------|---------------------------|
| XB5352G | SOT23-5 | 4.425 | 4.25 | 2.40 | 3.0 | 5 | 5352GYW _(note) |

注意: “YW”是生产日期, “Y” 是年份, “W” 是周号

管脚图

TOP VIEW

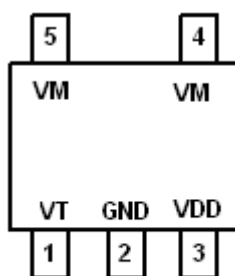

SOT23-5

管脚描述

| XB5352G 管脚号 | 管脚名称 | 管脚描述 |
|-------------|------|-------------------------|
| 1 | VT | 测试脚 |
| 2 | GND | 接地端, 接电池芯负极 |
| 3 | VDD | IC 供电端 |
| 4,5 | VM | 电池组的负端。内部 FET 开关连接到 GND |

绝对最大额定值

(注意: 为保护器件, 不允许超过以下最大额定值. 长时间工作在最大额定值条件下可能会影响产品的可靠性)

| 参数 | 数值 | 单位 |
|----------|-----------|----|
| VDD 输入电压 | -0.3 to 6 | V |
| VM 输入电压 | -6 to 10 | V |

XB5352G

| | | |
|---------------------------|------------|------|
| 工作环境温度 | -40 to 85 | °C |
| 最大结温 | 125 | °C |
| 储存温度 | -55 to 150 | °C |
| 引脚温度 (焊接, 10 秒) | 300 | °C |
| 环境温度 25°C 时的功耗 | 0.625 | W |
| 封装热阻 (结温) θ_{JA} | 250 | °C/W |
| 封装热阻 (结到环境) θ_{JA} | 130 | °C/W |
| ESD | 2000 | V |

电气特性

除非特殊说明, 所有指标均为 T=25°C 条件下

| 参数 | 标识 | 测试条件 | 最小值 | 典型值 | 最大值 | 单位 |
|----------------|---------------------|-----------------------|-------|-------|-------|----|
| 检测电压 | | | | | | |
| 过充检测电压 | V _{CU} | | 4.375 | 4.425 | 4.475 | V |
| 过充恢复电压 | V _{CL} | | 4.20 | 4.25 | 4.30 | V |
| 过放检测电压 | V _{DL} | | 2.3 | 2.4 | 2.5 | V |
| 过放恢复电压 | V _{DR} | | 2.9 | 3.0 | 3.1 | V |
| 检测电流 | | | | | | |
| 过放电流 1 检测电流 | *I _{IOV1} | VDD=3.6 | | 5 | | A |
| 负载短路检测电流 | *I _{SHORT} | VDD=3.6 | | 20 | | A |
| 电流功耗 | | | | | | |
| 正常工作功耗 | I _{OPE} | VDD=3.6 VM=0V | | 2.8 | 6 | μA |
| 关机功耗 | I _{PDN} | VDD=2.0V VM pin 悬空 | | 1.5 | 3 | μA |
| VM 端电阻 | | | | | | |
| VM 和 VDD 间内部电阻 | *R _{VMD} | VDD=2.0V VM pin 悬空 | | 320 | | kΩ |
| VM 和 GND 间内部电阻 | *R _{VMS} | VDD=3.6V VM=1.0V | | 100 | | kΩ |

| FET 导通电阻 | | | | | | |
|-----------------|----------------------|-----------------------|----|-----|----|----|
| FET 等效导通电阻 | *R _{SS(ON)} | VDD=3.6V IVM =1.0A | 40 | 45 | 55 | mΩ |
| 过温保护 | | | | | | |
| 过温保护温度 | *T _{SHD+} | | | 120 | | °C |
| 过温保护恢复温度 | *T _{SHD-} | | | 100 | | |
| 检测延时 | | | | | | |
| 过充检测延时 | t _{CU} | | | 130 | | mS |
| 过放检测延时 | t _{DL} | | | 40 | | mS |
| 过流检测延时 | *t _{IOV} | VDD=3.6 | | 10 | | mS |
| 短路检测延时 | *t _{SHORT} | VDD=3.6 | | 75 | | uS |

注:*—该参数设计保证，成测不测

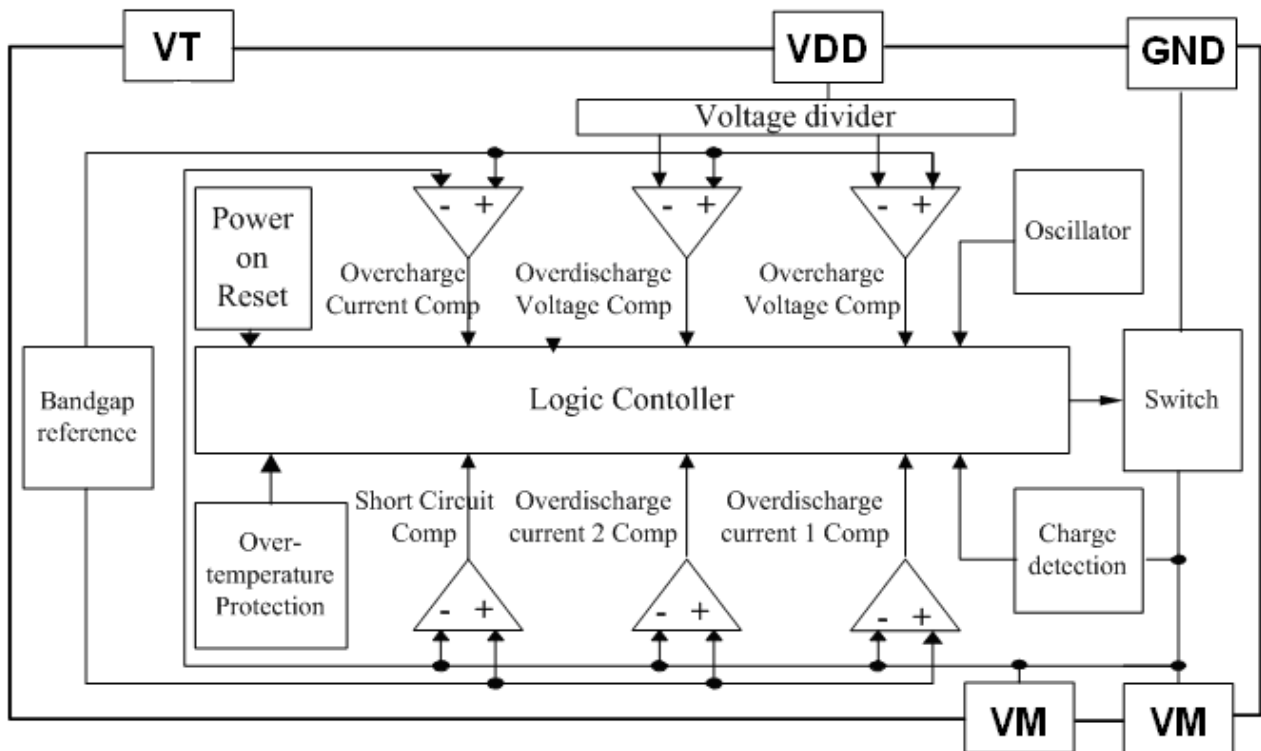

Figure 3. Functional Block Diagram

FUNCTIONAL DESCRIPTION

The XB5352G monitors the voltage and current of a battery and protects it from being damaged due to overcharge voltage, overdischarge voltage, overdischarge current, and short circuit conditions by disconnecting the battery from the load or charger. These functions are required in order to operate the battery cell within specified limits.

The device requires only one external capacitor. The MOSFET is integrated and its $R_{DS(ON)}$ is as low as $45m\Omega$ typical.

Normal operating mode

If no exception condition is detected, charging and discharging can be carried out freely. This condition is called the normal operating mode.

Overcharge Condition

When the battery voltage becomes higher than the overcharge detection voltage (V_{CU}) during charging under normal condition and the state continues for the overcharge detection delay time (t_{CU}) or longer, the XB5352G turns the charging control FET off to stop charging. This condition is called the overcharge condition. The overcharge condition is released in the following two cases:

- 1, When the battery voltage drops below the overcharge release voltage (V_{CL}), the XB5352G turns the charging control FET on and returns to the normal condition.
- 2, When a load is connected and discharging starts, the XB5352G turns the charging control FET on and returns to the normal condition. The release mechanism is as follows: the discharging current flows through an internal parasitic diode of the charging FET immediately after a load is connected and discharging starts, and the VM pin voltage increases about 0.7 V (forward voltage of the diode) from the GND pin voltage momentarily. The

XB5352G detects this voltage and releases the overcharge condition. Consequently, in the case that the battery voltage is equal to or lower than the overcharge detection voltage (V_{CU}), the XB5352G returns to the normal condition immediately, but in the case the battery voltage is higher than the overcharge detection voltage (V_{CU}), the chip does not return to the normal condition until the battery voltage drops below the overcharge detection voltage (V_{CU}) even if the load is connected. In addition, if the VM pin voltage is equal to or lower than the overcurrent 1 detection voltage when a load is connected and discharging starts, the chip does not return to the normal condition.

Remark If the battery is charged to a voltage higher than the overcharge detection voltage (V_{CU}) and the battery voltage does not drop below the overcharge detection voltage (V_{CU}) even when a heavy load, which causes an overcurrent, is connected, the overcurrent 1 and overcurrent 2 do not work until the battery voltage drops below the overcharge detection voltage (V_{CU}). Since an actual battery has, however, an internal impedance of several dozens of $m\Omega$, and the battery voltage drops immediately after a heavy load which causes an overcurrent is connected, the overcurrent 1 and overcurrent 2 work. Detection of load short-circuiting works regardless of the battery voltage.

Overdischarge Condition

When the battery voltage drops below the overdischarge detection voltage (V_{DL}) during discharging under normal condition and it continues for the overdischarge detection delay time (t_{DL}) or longer, the XB5352G turns the discharging control FET off and stops discharging. This condition is called overdischarge condition. After the discharging control FET is turned off, the VM pin is pulled up by the R_{VMD} resistor between VM and VDD in XB5352G. Meanwhile when VM is bigger than 1.5

V (typ.) (the load short-circuiting detection voltage), the current of the chip is reduced to the power-down current (I_{PDN}). This condition is called power-down condition. The VM and VDD pins are shorted by the R_{VMD} resistor in the IC under the overdischarge and power-down conditions. The power-down condition is released when a charger is connected and the potential difference between VM and VDD becomes 1.3 V (typ.) or higher (load short-circuiting detection voltage). At this time, the FET is still off. When the battery voltage becomes the overdischarge detection voltage (V_{DL}) or higher (see note), the XB5352G turns the FET on and changes to the normal condition from the overdischarge condition.

Remark If the VM pin voltage is no less than the charger detection voltage (V_{CHA}), when the battery under overdischarge condition is connected to a charger, the overdischarge condition is released (the discharging control FET is turned on) as usual, provided that the battery voltage reaches the overdischarge release voltage (V_{DU}) or higher.

Overcurrent Condition

When the discharging current becomes equal to or higher than a specified value (the VM pin voltage is equal to or higher than the overcurrent detection voltage) during discharging under normal condition and the state continues for the overcurrent detection delay time or longer, the XB5352G turns off the discharging control FET to stop discharging. This condition is called overcurrent condition. (The overcurrent includes overcurrent, or load short-circuiting.)

The VM and GND pins are shorted internally by the R_{VMS} resistor under the overcurrent condition. When a load is connected, the VM pin voltage equals the VDD voltage due to the load.

The overcurrent condition returns to the normal condition when the load is released and the impedance between the B+ and B-

pins becomes higher than the automatic recoverable impedance. When the load is removed, the VM pin goes back to the GND potential since the VM pin is shorted the GND pin with the R_{VMS} resistor. Detecting that the VM pin potential is lower than the overcurrent detection voltage (V_{IOV}), the IC returns to the normal condition.

Abnormal Charge Current Detection

If the VM pin voltage drops below the charger detection voltage (V_{CHA}) during charging under the normal condition and it continues for the overcharge detection delay time (t_{CU}) or longer, the XB5352G turns the charging control FET off and stops charging. This action is called abnormal charge current detection.

Abnormal charge current detection works when the discharging control FET is on and the VM pin voltage drops below the charger detection voltage (V_{CHA}). When an abnormal charge current flows into a battery in the overdischarge condition, the XB5352G consequently turns the charging control FET off and stops charging after the battery voltage becomes the overdischarge detection voltage and the overcharge detection delay time (t_{CU}) elapses.

Abnormal charge current detection is released when the voltage difference between VM pin and GND pin becomes lower than the charger detection voltage (V_{CHA}) by separating the charger. Since the 0 V battery charging function has higher priority than the abnormal charge current detection function, abnormal charge current may not be detected by the product with the 0 V battery charging function while the battery voltage is low.

Load Short-circuiting condition

If voltage of VM pin is equal or below short circuiting protection voltage (V_{SHORT}), the XB5352G will stop discharging

and battery is disconnected from load. The maximum delay time to switch current off is t_{SHORT} . This status is released when voltage of VM pin is higher than short protection voltage (V_{SHORT}), such as when disconnecting the load.

Delay Circuits

The detection delay time for overdischarge current 2 and load short-circuiting starts when overdischarge current 1 is detected. As soon as overdischarge current 2 or load short-circuiting is detected over detection delay time for overdischarge current 2 or load short-circuiting, the XB5352G stops discharging. When battery voltage falls below overdischarge detection voltage due to overdischarge current, the XB5352G stop discharging by overdischarge current detection. In this case the recovery of battery voltage is so slow that if battery voltage after overdischarge voltage detection delay time is still lower than overdischarge detection voltage, the XB5352G shifts to power-down.

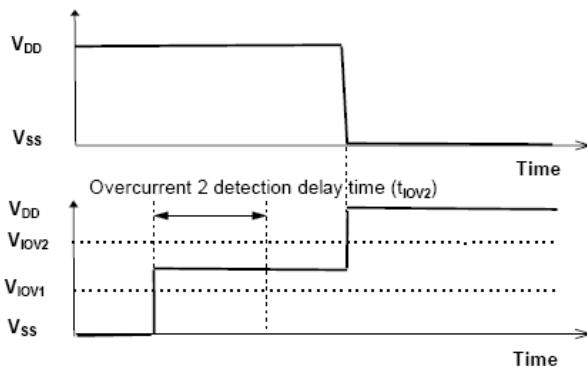

Figure 4. Overcurrent delay time

0V Battery Charging Function ^{(1) (2) (3)}

This function enables the charging of a connected battery whose voltage is 0 V by self-discharge. When a charger having 0 V battery start charging charger voltage (V_{OCHA}) or higher is connected between B+ and B- pins, the charging control FET gate is fixed to VDD potential. When the voltage between the gate and the source of the charging control FET becomes equal to or higher than the turn-on voltage by the charger voltage, the charging control FET is turned on to start charging. At this time, the discharging control FET is off and the charging current flows through the internal parasitic diode in the discharging control FET. If the battery voltage becomes equal to or higher than the overdischarge release voltage (V_{DU}), the normal condition returns.

Note

- (1) Some battery providers do not recommend charging of completely discharged batteries. Please refer to battery providers before the selection of 0 V battery charging function.
- (2) The 0V battery charging function has higher priority than the abnormal charge current detection function. Consequently, a product with the 0 V battery charging function charges a battery and abnormal charge current cannot be detected during the battery voltage is low (at most 1.8 V or lower).
- (3) When a battery is connected to the IC for the first time, the IC may not enter the normal condition in which discharging is possible. In this case, set the VM pin voltage equal to the GND voltage (short the VM and GND pins or connect a charger) to enter the normal condition.

TIMING CHART

1. Overcharge and overdischarge detection

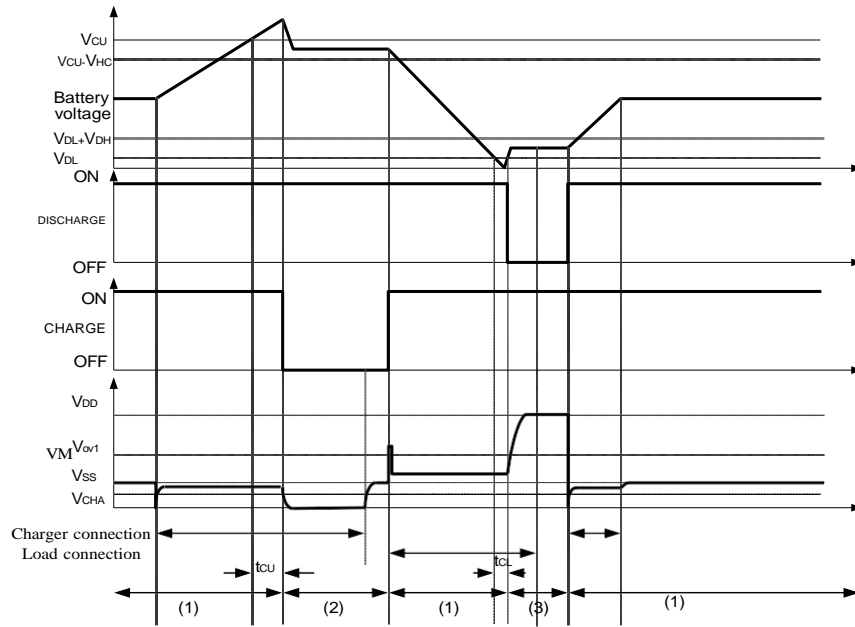

Figure5-1 Overcharge and Overdischarge Voltage Detection

2. Overdischarge current detection

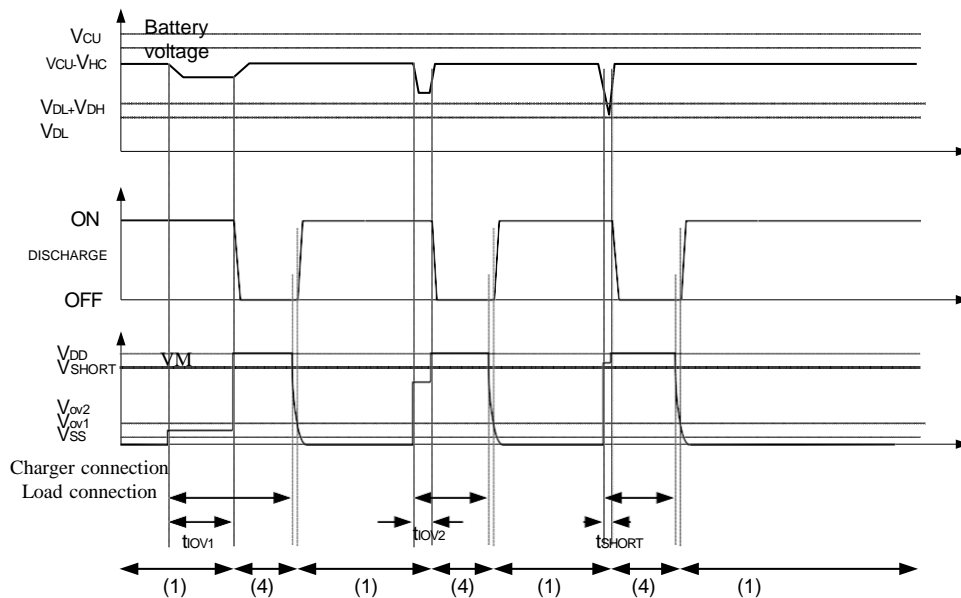

Figure5-2 Overdischarge Current Detection

Remark: (1) Normal condition (2) Overcharge voltage condition (3) Overdischarge voltage condition (4) Overcurrent condition

3. Charger Detection

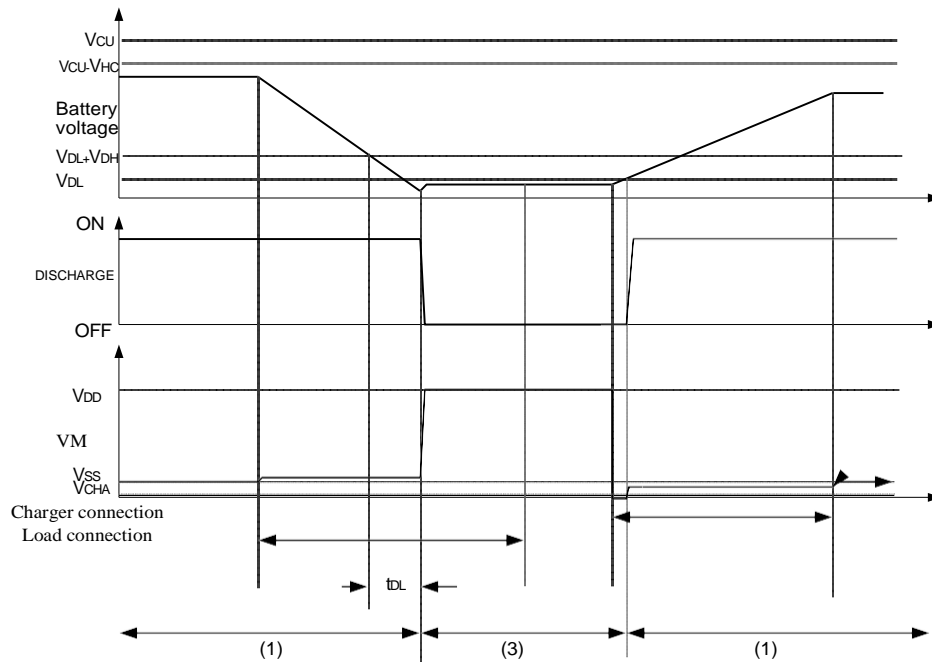

Figure5-3 Charger Detection

4. Abnormal Charger Detection

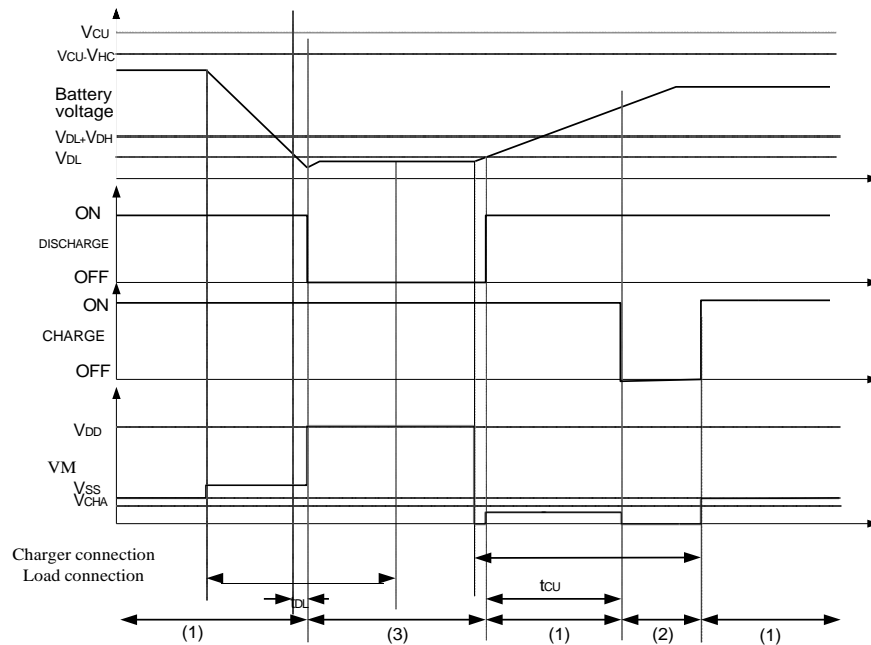

Figure5-4 Abnormal Charger Detection

Remark: (1) Normal condition (2) Overcharge voltage condition (3) Overdischarge voltage condition (4) Overcurrent condition

TYPICAL APPLICATION

As shown in Figure 6, the bold line is the high density current path which must be kept as short as possible. For thermal management, ensure that these trace widths are adequate. C1 is a decoupling capacitor which should be placed as close as possible to XB5352G.

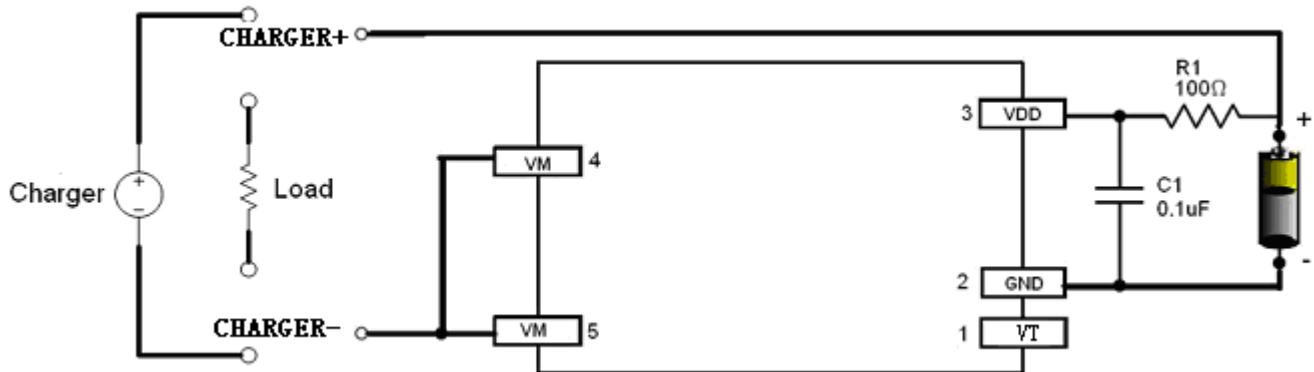

Fig 6 XB5352G in a Typical Battery Protection Circuit

Precautions

- Pay attention to the operating conditions for input/output voltage and load current so that the power loss in XB5352G does not exceed the power dissipation of the package.
- Do not apply an electrostatic discharge to this XB5352G that exceeds the performance ratings of the built-in electrostatic protection circuit.

PACKAGE OUTLINE

SOT23-5 PACKAGE OUTLINE AND DIMENSIONS

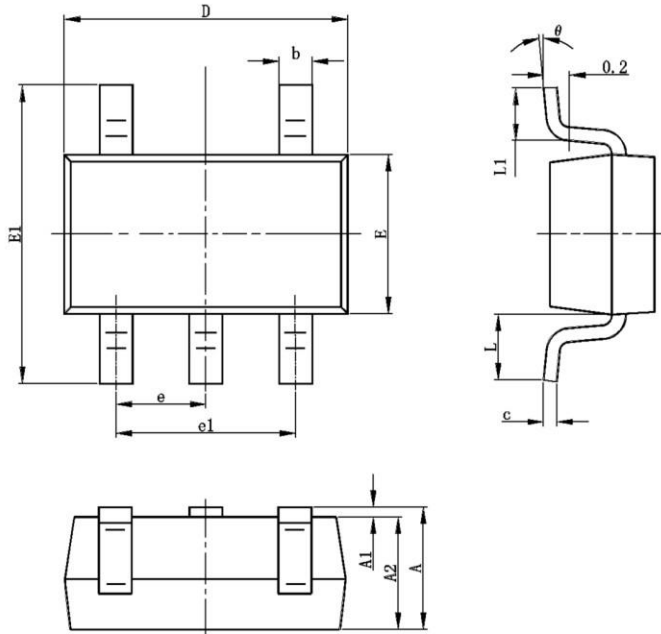

| SYMBOL | DIMENSION IN MILLIMETERS | | DIMENSION IN INCHES | |
|--------|--------------------------|-------|---------------------|-------|
| | MIN | MAX | MIN | MAX |
| A | 1.050 | 1.250 | 0.041 | 0.049 |
| A1 | 0.000 | 0.100 | 0.000 | 0.004 |
| A2 | 1.050 | 1.150 | 0.041 | 0.045 |
| b | 0.300 | 0.400 | 0.012 | 0.016 |
| c | 0.100 | 0.200 | 0.004 | 0.008 |
| D | 2.820 | 3.020 | 0.111 | 0.119 |
| E | 1.500 | 1.700 | 0.059 | 0.067 |
| E1 | 2.650 | 2.950 | 0.104 | 0.116 |
| e | 0.950 TYP | | 0.037 TYP | |
| e1 | 1.800 | 2.000 | 0.071 | 0.079 |
| L | 0.700 REF | | 0.028 REF | |
| L1 | 0.300 | 0.600 | 0.012 | 0.024 |
| θ | 0° | 8° | 0° | 8° |

DISCLAIMER

The information described herein is subject to change without notice.

Xysemi Inc. is not responsible for any problems caused by circuits or diagrams described herein whose related industrial properties, patents, or other rights belong to third parties. The application circuit examples explain typical applications of the products, and do not guarantee the success of any specific mass-production design.

When the products described herein are regulated products subject to the Wassenaar Arrangement or other arrangements, they may not be exported without authorization from the appropriate governmental authority.

Use of the information described herein for other purposes and/or reproduction or copying without express permission of Xysemi Inc. is strictly prohibited.

The products described herein cannot be used as part of any device or equipment affecting the human body, such as exercise equipment, medical equipment, security systems, gas equipment, or any apparatus installed in airplanes and other vehicles, without prior written permission of Xysemi Inc.

Although Xysemi Inc. exerts the greatest possible effort to ensure high quality and reliability, the failure or malfunction of semiconductor may occur. The use of these products should therefore give thorough consideration to safety design, including redundancy, fire-prevention measure and malfunction prevention, to prevent any accidents, fires, or community damage that may ensue.

X-ON Electronics

Largest Supplier of Electrical and Electronic Components

Click to view similar products for [Battery Management](#) category:

Click to view products by [XySemi](#) manufacturer:

Other Similar products are found below :

[VN5R003HTR-E](#) [NCP1855FCCT1G](#) [FAN54063UCX](#) [NCP367DPMUEBTBG](#) [LC05132C01NMTTTG](#) [ISL78714ANZ](#) [CM1104-EH](#)
[CM1104-DBB](#) [CM1104-MBB](#) [XC6801A421MR-G](#) [ISL95521BHRZ](#) [ISL95521BIRZ](#) [MP2639AGR-P](#) [S-82D1AAE-A8T2U7](#) [S-82D1AAA-](#)
[A8T2U7](#) [S-8224ABA-I8T1U](#) [MC33772CTA1AE](#) [MC33772CTC0AE](#) [BQ28Z610DRZR-R1](#) [MCP73832-4ADI/MC](#) [MCP73832T-2DCIMC](#)
[MCP73833T-AMIMF](#) [MCP73833T-AMI/UN](#) [MCP73838-NVI/MF](#) [MCP73213-A6BI/MF](#) [MCP73831-2ACI/MC](#) [MCP73831T-2ATIMC](#)
[MCP73832-2ACI/MC](#) [MCP73832T-3ACIMC](#) [MCP73833T-FCI/MF](#) [MCP73853-IML](#) [BQ25895RTWR](#) [BQ29704DSER](#) [BQ78Z100DRZR](#)
[ISL78610ANZ](#) [FAN5403UCX](#) [NCP367DPMUECTBG](#) [FAN54015BUCX](#) [MAX8934BETI+](#) [BQ24311DSGR](#) [BQ25100HYFPR](#)
[BQ29707DSER](#) [MAX17048G+T10](#) [BQ24130RHRLR](#) [BQ25120AYFPR](#) [BQ29703DSER](#) [BQ771807DPJR](#) [BQ25120AYFPT](#)
[MAX17055ETB+T](#) [MAX17710GB+T](#)