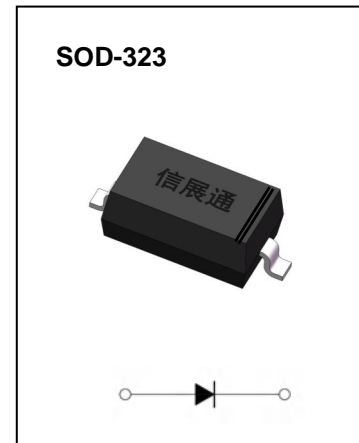

**FEATURES**

- Low Forward Voltage Drop
- Guard Ring Construction for Transient Protection
- High Conductance
- Also Available in Lead Free Version

MARKING:

| B0520WS | B0530WS | B0540WS |
|---------|---------|---------|
| | | |

**Maximum Ratings and Electrical Characteristics, Single Diode @Ta=25°C**

| Parameter | Symbol | B0520WS | B0530WS | B0540WS | Unit |
|---|---------------------------------|------------|---------|---------|------|
| Non-Repetitive Peak Reverse Voltage | V_{RM} | 20 | 30 | 40 | V |
| Peak Repetitive Peak Reverse Voltage Working Peak Reverse Voltage DC Blocking Voltage | V_{RRM} V_{RWM} V_R | 20 | 30 | 40 | V |
| RMS Reverse Voltage | $V_{R(RMS)}$ | 14 | 21 | 28 | V |
| Average Rectified Output Current | I_O | 0.5 | | | A |
| Non-repetitive Peak Forward Surge Current @t=8.3ms | I_{FSM} | 5.5 | | | A |
| Repetitive Peak Forward Current | I_{FRM} | 1.5 | | | A |
| Power Dissipation | P_D | 200 | | | mW |
| Thermal Resistance Junction to Ambient | $R_{\theta JA}$ | 500 | | | °C/W |
| Operating Junction Temperature Range | T_J | -40 ~ +125 | | | °C |
| Storage Temperature Range | T_{STG} | -55 ~ +150 | | | °C |

ELECTRICAL CHARACTERISTICS (Ta=25°C unless otherwise specified)

| Parameter | Symbol | Test conditions | Min | Max | Unit |
|---------------------------------|------------|----------------------|--------------|-------|------|
| Reverse breakdown voltage | $V_{(BR)}$ | $I_R = 1mA$ | | | V |
| | | B0520WS | 20 | | |
| | | B0530WS B0540WS | 30 40 | | |
| Reverse voltage leakage current | I_R | $V_R = 20V$ | | 0.25 | mA |
| | | $V_R = 30V$ | | 0.50 | |
| | | $V_R = 40V$ | | 0.02 | |
| Forward voltage | V_F | B0520WS | $I_F = 0.1A$ | 0.330 | V |
| | | | $I_F = 0.5A$ | 0.390 | |
| | | B0530WS | $I_F = 0.1A$ | 0.375 | V |
| | | | $I_F = 0.5A$ | 0.450 | |
| | | B0540WS | $I_F = 0.5A$ | 0.510 | V |
| | | | $I_F = 1A$ | 0.620 | |
| Diode capacitance | C_D | $V_R = 4V, f = 1MHz$ | | 170 | pF |



Typical Characteristics

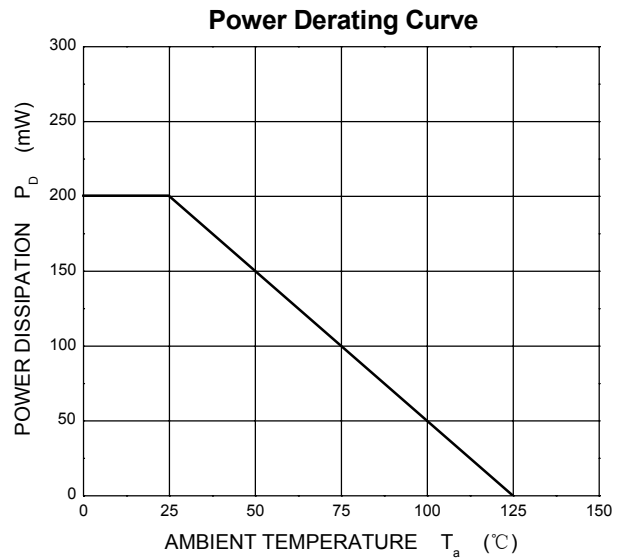
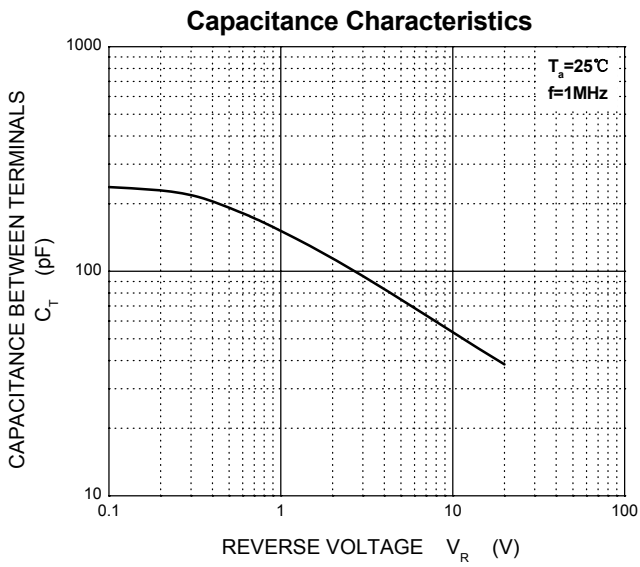
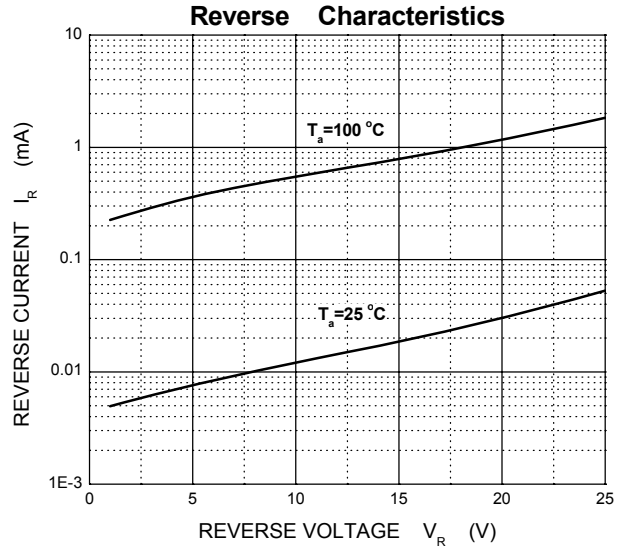
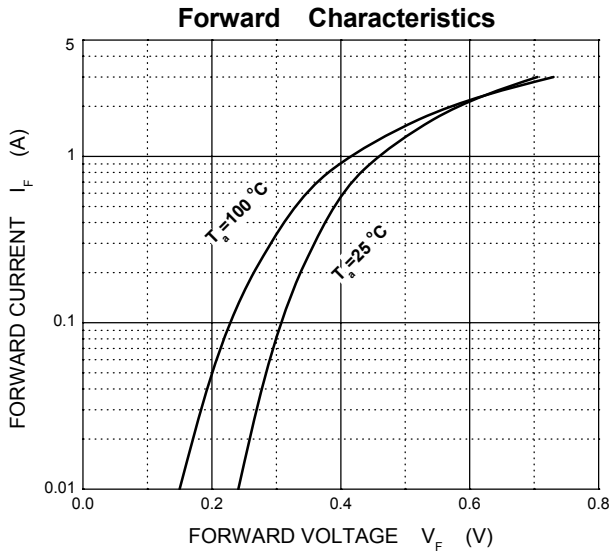



SOD-323 Package Outline Dimensions

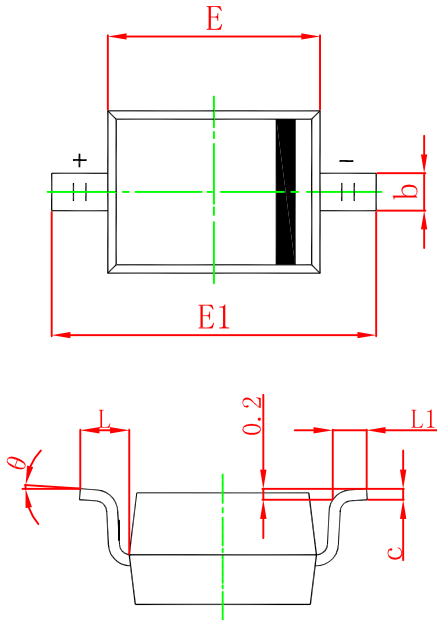

| Symbol | Dimensions In Millimeters | | Dimensions In Inches | |
|--------|---------------------------|-------|----------------------|-------|
| | Min | Max | Min | Max |
| A | | 1.100 | | 0.043 |
| A1 | 0.000 | 0.100 | 0.000 | 0.004 |
| A2 | 0.800 | 1.000 | 0.031 | 0.039 |
| b | 0.250 | 0.350 | 0.010 | 0.014 |
| c | 0.080 | 0.150 | 0.003 | 0.006 |
| D | 1.200 | 1.400 | 0.047 | 0.055 |
| E | 1.600 | 1.800 | 0.063 | 0.071 |
| E1 | 2.500 | 2.750 | 0.098 | 0.108 |
| L | 0.475 REF | | 0.019 REF | |
| L1 | 0.250 | 0.400 | 0.010 | 0.016 |
| θ | 0° | 8° | 0° | 8° |

SOD-323 Suggested Pad Layout

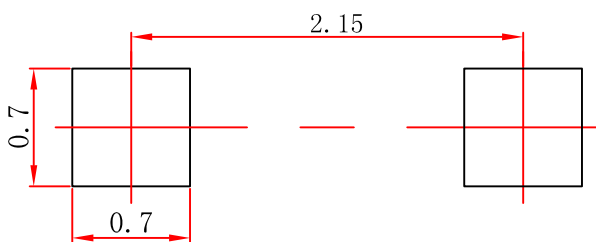

Note:

1. Controlling dimension: in millimeters.
2. General tolerance: $\pm 0.05\text{mm}$.
3. The pad layout is for reference purposes only.

X-ON Electronics

Largest Supplier of Electrical and Electronic Components

Click to view similar products for [Schottky Diodes & Rectifiers](#) category:

Click to view products by [XZT](#) manufacturer:

Other Similar products are found below :

[MA4E2039](#) [MMBD301M3T5G](#) [HFA35HB60C](#) [RB160M-50TR](#) [D83C](#) [BAS16E6433HTMA1](#) [BAS 3010S-02LRH](#) [E6327](#) [BAT 54-02LRH](#)
[E6327](#) [NRVBAF360T3G](#) [NSR05F40QNXT5G](#) [NTE555](#) [JANS1N6640](#) [SS3003CH-TL-E](#) [GA01SHT18](#) [CRS10I30A\(TE85L,QM](#)
[MBRA140TRPBF](#) [MBRB30H30CT-1G](#) [BAT 15-04R](#) [E6152](#) [JANTX1N5712-1](#) [DMJ3940-000](#) [SB007-03C-TB-E](#) [NRVBB20100CTT4G](#)
[NRVBM120LT1G](#) [NTSB30U100CT-1G](#) [CRG04\(T5L,TEMQ\)](#) [ACDBA1100LR-HF](#) [ACDBA1200-HF](#) [ACDBA240-HF](#) [ACDBA3100-HF](#)
[CDBQC0530L-HF](#) [ACDBA260LR-HF](#) [ACDBA1100-HF](#) [10BQ015-M3/5BT](#) [NRVBM120ET1G](#) [VSSB410S-M3/5BT](#) [1N5819T-G](#)
[PDS1040Q-13](#) [B160BQ-13-F](#) [SDM05U20CSP-7](#) [BAS 70-07](#) [E6433](#) [B140S1F-7](#) [HSM560Je3/TR13](#) [DDB2265-000](#) [ZHCS506QTA](#)
[HSM190Je3/TR13](#) [B330AF-13](#) [ACDBUC0230-HF](#) [SDM1U100S1F-7](#) [MBR10200CTF-G1](#) [CDLL5712](#)