

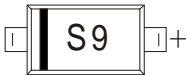

FEATURES

- High breakdown voltage
- Low turn-on voltage
- Guard ring construction for transient protection

MARKING: S9

Maximum Ratings @ $T_a=25^{\circ}\text{C}$

Parameter	Symbol	Limit	Unit
Peak repetitive peak reverse voltage	V_{RRM}	100	V
Working peak reverse voltage	V_{RWM}		
Forward continuous current	I_F	150	mA
Repetitive peak forward current (Note 1) @ $t_p < 1.0\text{s}$, Duty Cycle < 50%	I_{FRM}	350	mA
Non-repetitive Peak Forward surge current @ $t = 8.3\text{ms}$	I_{FSM}	750	mA
Power dissipation	P_D	200	mW
Thermal resistance junction to ambient air	$R_{\theta JA}$	500	$^{\circ}\text{C}/\text{W}$
Operating Junction Temperature Range	T_j	-40 ~ +125	$^{\circ}\text{C}$
Storage Temperature Range	T_{STG}	-55 ~ +150	$^{\circ}\text{C}$

ELECTRICAL CHARACTERISTICS ($T_a=25^{\circ}\text{C}$ unless otherwise specified)

Parameter	Symbol	Test Conditions	Min	Typ	Max	Unit
Reverse breakdown voltage(Note 2)	V_R	$I_R=100\mu\text{A}$	100			V
Reverse voltage leakage current	I_R	$V_{R1}=1.5\text{V}$			0.3	μA
		$V_{R2}=10\text{V}$			0.5	
		$V_{R3}=50\text{V}$			1	
		$V_{R4}=75\text{V}$			2	
Forward voltage(Note 2)	V_F	$I_{F1}=0.1\text{mA}$			0.25	V
		$I_{F2}=10\text{mA}$			0.45	
		$I_{F3}=250\text{mA}$			1	
Diode capacitance	C_T	$V_R=0, f=1\text{MHz}$		20		pF
		$V_R=1\text{V}, f=1\text{MHz}$		12		

Notes: 1. Part mounted on FR-4 board with recommended pad layout.

2. Short duration pulse test used to minimize self-heating effect.



Typical Characteristics

Forward Characteristics

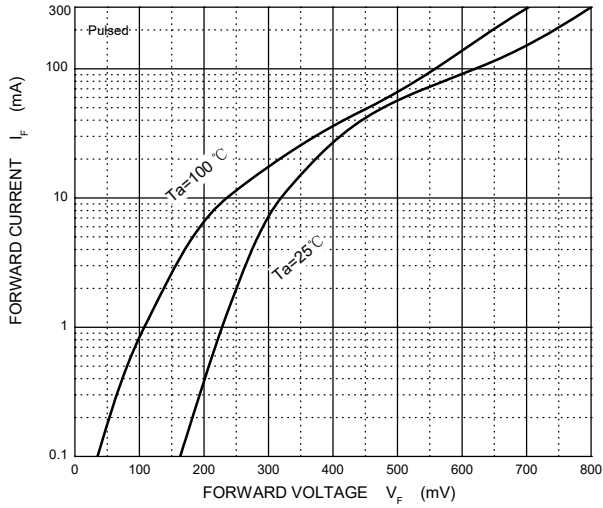

Reverse Characteristics

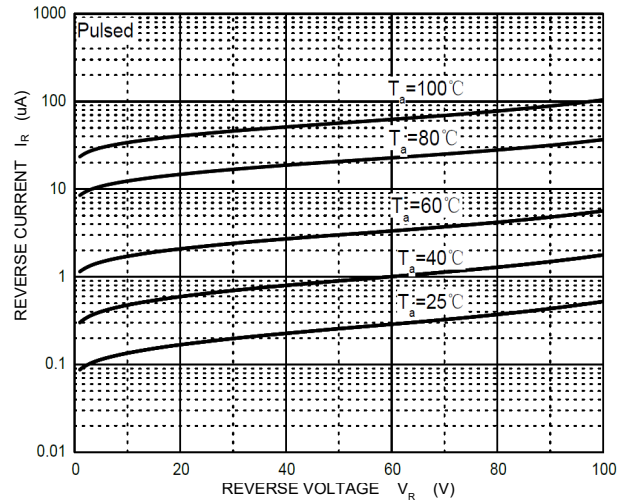

Capacitance Characteristics

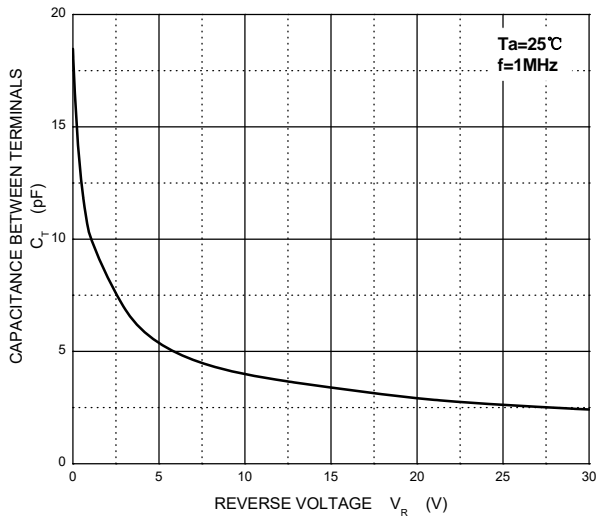

Power Derating Curve

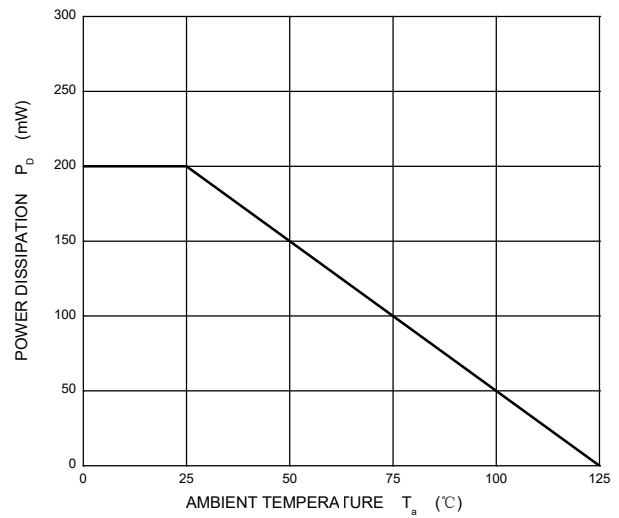



SOD-323 Package Outline Dimensions

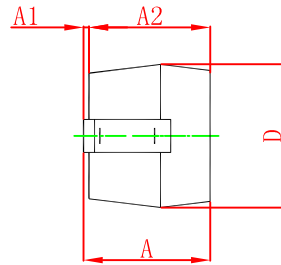
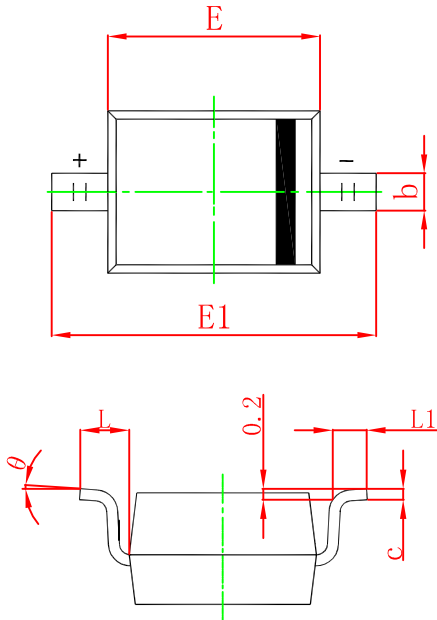

Symbol	Dimensions In Millimeters		Dimensions In Inches	
	Min	Max	Min	Max
A		1.100		0.043
A1	0.000	0.100	0.000	0.004
A2	0.800	1.000	0.031	0.039
b	0.250	0.350	0.010	0.014
c	0.080	0.150	0.003	0.006
D	1.200	1.400	0.047	0.055
E	1.600	1.800	0.063	0.071
E1	2.500	2.750	0.098	0.108
L	0.475 REF		0.019 REF	
L1	0.250	0.400	0.010	0.016
θ	0°	8°	0°	8°

SOD-323 Suggested Pad Layout

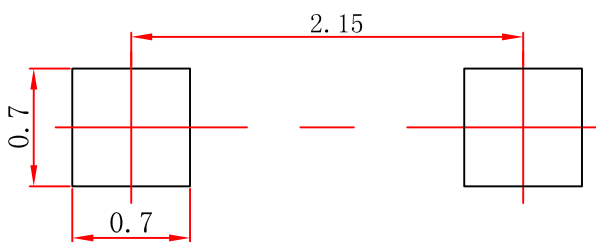

Note:

1. Controlling dimension: in millimeters.
2. General tolerance: $\pm 0.05\text{mm}$.
3. The pad layout is for reference purposes only.

X-ON Electronics

Largest Supplier of Electrical and Electronic Components

Click to view similar products for [Schottky Diodes & Rectifiers](#) category:

Click to view products by [XZT](#) manufacturer:

Other Similar products are found below :

[MA4E2039](#) [MMBD301M3T5G](#) [HFA35HB60C](#) [RB160M-50TR](#) [D83C](#) [BAS16E6433HTMA1](#) [BAS 3010S-02LRH](#) [E6327](#) [BAT 54-02LRH](#)
[E6327](#) [NRVBAF360T3G](#) [NSR05F40QNXT5G](#) [NTE555](#) [JANS1N6640](#) [SS3003CH-TL-E](#) [GA01SHT18](#) [CRS10I30A\(TE85L,QM](#)
[MBRA140TRPBF](#) [MBRB30H30CT-1G](#) [BAT 15-04R](#) [E6152](#) [JANTX1N5712-1](#) [DMJ3940-000](#) [SB007-03C-TB-E](#) [NRVBB20100CTT4G](#)
[NRVBM120LT1G](#) [NTSB30U100CT-1G](#) [CRG04\(T5L,TEMQ\)](#) [ACDBA1100LR-HF](#) [ACDBA1200-HF](#) [ACDBA240-HF](#) [ACDBA3100-HF](#)
[CDBQC0530L-HF](#) [ACDBA260LR-HF](#) [ACDBA1100-HF](#) [10BQ015-M3/5BT](#) [NRVBM120ET1G](#) [VSSB410S-M3/5BT](#) [1N5819T-G](#)
[PDS1040Q-13](#) [B160BQ-13-F](#) [SDM05U20CSP-7](#) [BAS 70-07](#) [E6433](#) [B140S1F-7](#) [HSM560Je3/TR13](#) [DDB2265-000](#) [ZHCS506QTA](#)
[HSM190Je3/TR13](#) [B330AF-13](#) [ACDBUC0230-HF](#) [SDM1U100S1F-7](#) [MBR10200CTF-G1](#) [CDLL5712](#)