

# DATA SHEET

## METAL OXIDE VARISTORS POWER SUPPLY

14D series

RoHS compliant & Halogen free



Product specification— May 08, 2021 V.2



## Metal Oxide Varistor (MOV) Data Sheet

### Features

- Wide operating voltage ( $V_{1mA}$ ) range from 18V to 1800V
- Fast responding to transient over-voltage
- Large absorbing transient energy capability
- Low clamping ratio and no follow-on current
- Meets MSL level 1, per J-STD-020
- Operating Temperature:  $-40^{\circ}\text{C} \sim +105^{\circ}\text{C}$
- Storage Temperature:  $-40^{\circ}\text{C} \sim +125^{\circ}\text{C}$
- Safety certification: UL、CSA、VDE



### Applications

- Transistor, diode, IC, thyristor or triac semiconductor protection
- Surge protection in consumer electronics
- Surge protection in industrial electronics
- Surge protection in electronic home appliances, gas and petroleum appliances
- Relay and electromagnetic valve surge absorption

### Part Number Code

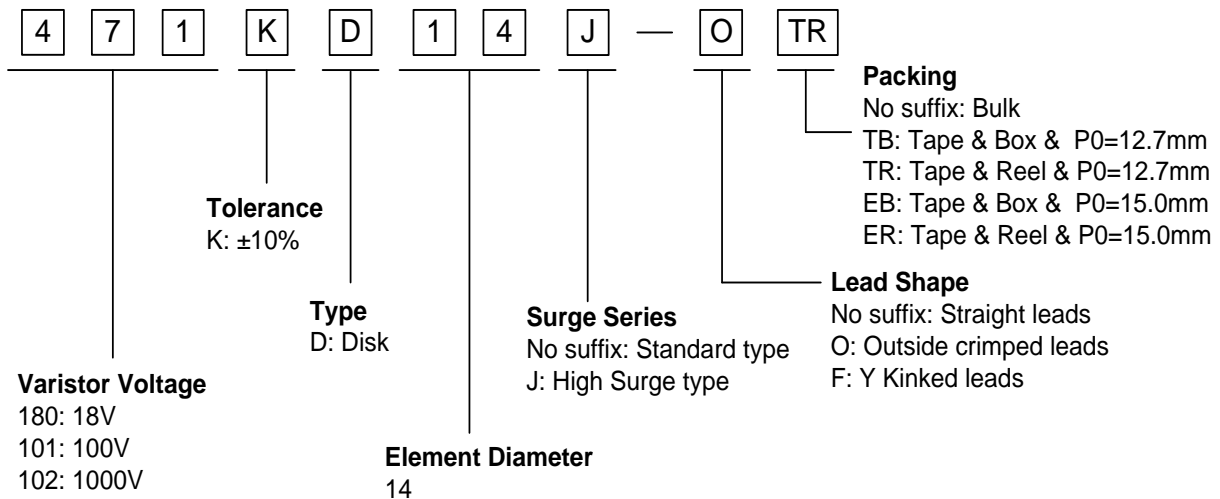

Dimensions

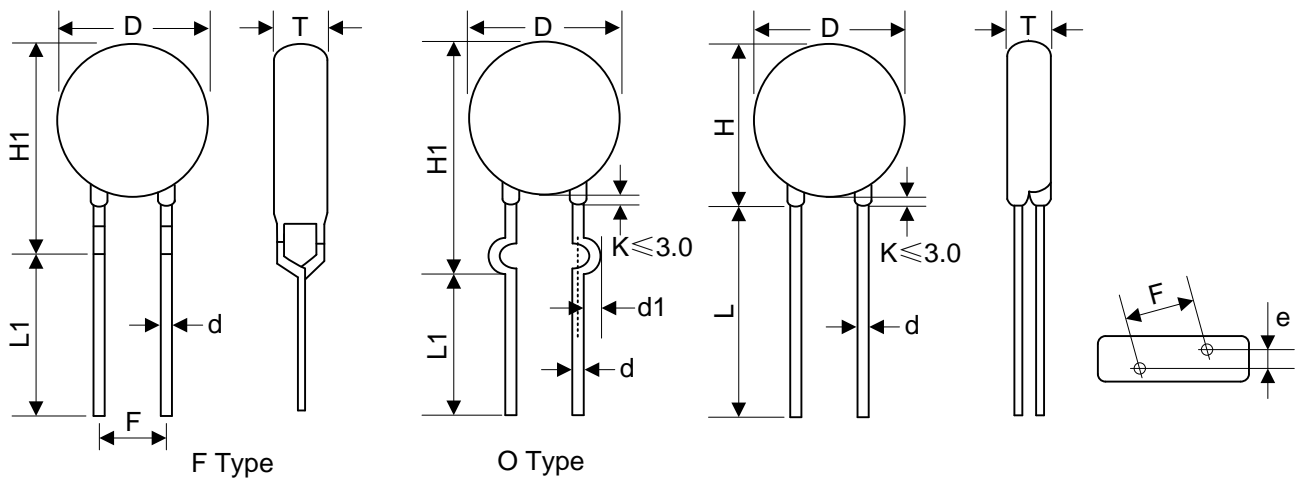

Notes: Varistor voltage ≥ 1200V, structure diagram is F type.

Table 1	
Unit: mm	
Symbol	Dimension
H	14.5~20.0
H1	17.0~21.0
L(min.)	20.0
L1(min.)	15.0
D	14.0~16.5
F(±0.8)	7.5
T	Table 2
e(±0.8)	Table 2
d(±0.05)	0.8
d1(±0.4)	1.4

Table 2					
Unit: mm					
Model	T	e	Model	T	e
180K	2.0~3.9	1.5	361K	2.9~5.2	2.7
220K	2.1~4.0	1.6	391K	3.0~5.4	2.8
270K	2.1~4.1	1.8	431K	3.2~5.6	3.0
330K	2.2~4.3	1.7	471K	3.3~5.8	3.2
390K	2.1~4.1	1.8	511K	3.4~6.1	3.4
470K	2.2~4.3	1.9	561K	3.6~6.4	3.6
560K	2.3~4.6	2.1	621K	3.8~6.8	3.9
680K	2.4~4.8	2.4	681K	4.0~7.1	4.2
820K	2.1~4.1	1.8	751K	4.3~7.2	4.3
101K	2.4~4.2	2.0	781K	4.4~7.3	4.4
121K	2.4~4.4	2.2	821K	4.6~7.5	4.6
151K	2.2~4.1	1.8	911K	4.8~7.5	5.0
181K	2.3~4.2	1.9	102K	5.4~8.0	5.0
201K	2.4~4.3	2.0	112K	5.8~8.5	5.4
221K	2.5~4.4	2.1	122K	5.9~9.0	5.8
241K	2.6~4.5	2.2	142	6.9~10.5	6.6
271K	2.6~4.6	2.4	162	7.4~11.0	7.4
301K	2.7~4.6	2.5	182	7.6~12.0	8.2
331K	2.7~5.0	2.5			

## Electrical Characteristics

Part Number		Maximum Allowable Voltage		Varistor Voltage	Maximum Clamping Voltage		Withstanding Surge Current		Maximum Energy (10/1000 $\mu$ s)		Rated Power	Typical Capacitance (Reference)
Standard	High Surge	V <sub>AC</sub> (V)	V <sub>DC</sub> (V)	V <sub>1mA</sub> (V)	I <sub>P</sub> (A)	V <sub>C</sub> (V)	I (A) Standard	I (A) High Surge	(J) Standard	(J) High Surge	(W)	@ 1KHz (pf)
180KD14	180KD14J	11	14	18(15~21.6)	10	36	1000	2000	4.0	7.0	0.1	11100
220KD14	220KD14J	14	18	22(19.5~26)	10	43	1000	2000	5.0	8.0	0.1	9100
270KD14	270KD14J	17	22	27(24~31)	10	53	1000	2000	6.0	10.0	0.1	7400
330KD14	330KD14J	20	26	33(29.5~36.5)	10	65	1000	2000	7.5	12.0	0.1	6100
390KD14	390KD14J	25	31	39(35~43)	10	77	1000	2000	8.6	13.0	0.1	5100
470KD14	470KD14J	30	38	47(42~52)	10	93	1000	2000	10.0	17.0	0.1	4300
560KD14	560KD14J	35	45	56(50~62)	10	110	1000	2000	11.0	20.0	0.1	3600
680KD14	680KD14J	40	56	68(61~75)	10	135	1000	2000	14.0	24.0	0.1	2900
820KD14	820KD14J	50	65	82(74~90)	50	135	4500	6000	22.0	27.0	0.6	2400
101KD14	101KD14J	60	85	100(90~110)	50	165	4500	6000	28.0	33.0	0.6	2000
121KD14	121KD14J	75	100	120(108~132)	50	200	4500	6000	32.0	40.0	0.6	1700
151KD14	151KD14J	95	125	150(135~165)	50	250	4500	6000	40.0	53.0	0.6	1300
181KD14	181KD14J	115	150	180(162~198)	50	300	4500	6000	50.0	60.0	0.6	1100
201KD14	201KD14J	130	170	200(180~220)	50	340	4500	6000	57.0	70.0	0.6	1000
221KD14	221KD14J	140	180	220(198~242)	50	360	4500	6000	60.0	78.0	0.6	900
241KD14	241KD14J	150	200	240(216~264)	50	395	4500	6000	63.0	84.0	0.6	830
271KD14	271KD14J	175	225	270(243~297)	50	455	4500	6000	70.0	99.0	0.6	740
301KD14	301KD14J	190	250	300(270~330)	50	500	4500	6000	77.0	108	0.6	670
331KD14	331KD14J	210	275	330(297~363)	50	550	4500	6000	85.0	115	0.6	610
361KD14	361KD14J	230	300	360(324~396)	50	595	4500	6000	93.0	130	0.6	560
391KD14	391KD14J	250	320	390(351~429)	50	650	4500	6000	100	140	0.6	510
431KD14	431KD14J	275	350	430(387~473)	50	710	4500	6000	115	155	0.6	460
471KD14	471KD14J	300	385	470(423~517)	50	775	4500	6000	118	175	0.6	430
511KD14	511KD14J	320	415	510(459~561)	50	845	4500	6000	121	180	0.6	390
561KD14	561KD14J	350	460	560(504~616)	50	925	4500	6000	125	185	0.6	360
621KD14	621KD14J	385	505	620(558~682)	50	1025	4500	6000	128	190	0.6	320
681KD14	681KD14J	420	560	680(612~748)	50	1120	4500	6000	130	200	0.6	290
751KD14	751KD14J	460	615	750(675~825)	50	1240	4500	6000	143	210	0.6	270
781KD14	781KD14J	485	640	780(702~858)	50	1290	4500	6000	148	220	0.6	260
821KD14	821KD14J	510	670	820(738~902)	50	1355	4500	6000	157	235	0.6	240
911KD14	911KD14J	550	745	910(819~1001)	50	1500	4500	6000	175	255	0.6	220
102KD14	102KD14J	625	825	1000(900~1100)	50	1650	4500	6000	190	280	0.6	200
112KD14	112KD14J	680	895	1100(990~1210)	50	1815	4500	6000	213	310	0.6	180
122KD14	122KD14J	750	990	1200(1080~1320)	50	1980	4500	6000	232	324	0.6	160
142KD14	/	880	1140	1400(1260~1540)	50	2310	4500	/	238	/	0.6	150
162KD14	/	1000	1280	1600(1440~1760)	50	2640	4500	/	243	/	0.6	140
182KD14	/	1100	1465	1800(1620~1980)	50	2970	4500	/	250	/	0.6	130

- Notes: 1. The tolerance of varistor voltage between 18V and 27V is more than 10%;  
2. Varistor voltage  $\geq 1200V$ , structure diagram is F type;  
3. Leakage Current (@83% of V<sub>1mA</sub>): IR $\leq 50\mu A$  (180K~680K) ; IR $\leq 25\mu A$  (820K~182K).

**Maximum Surge Current Derating Curve**

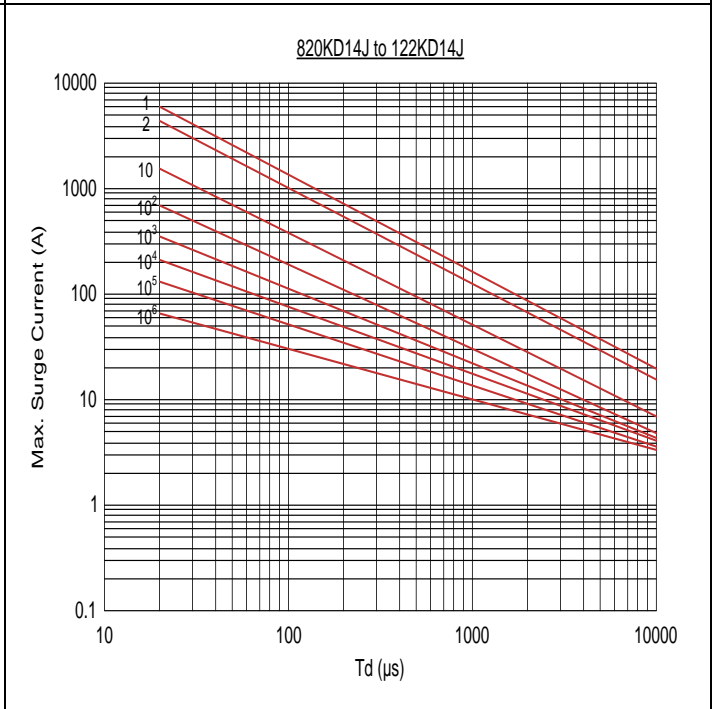
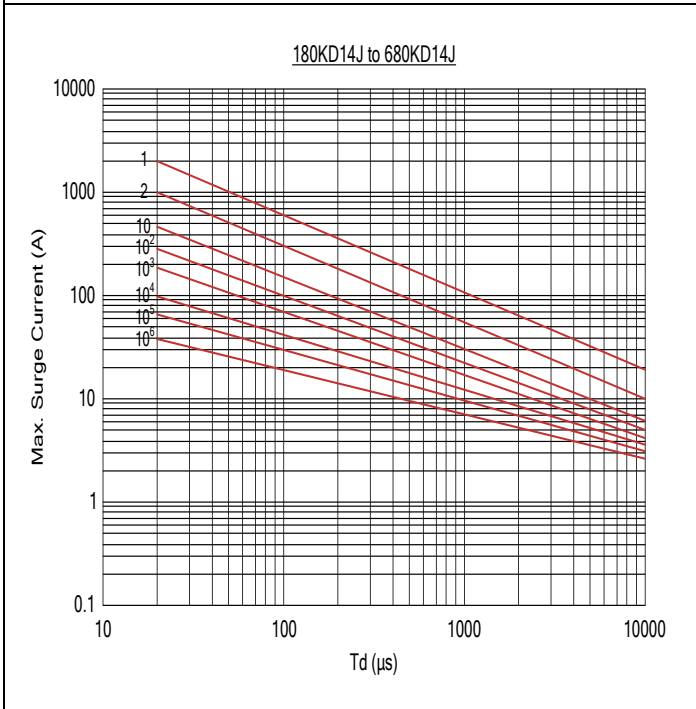
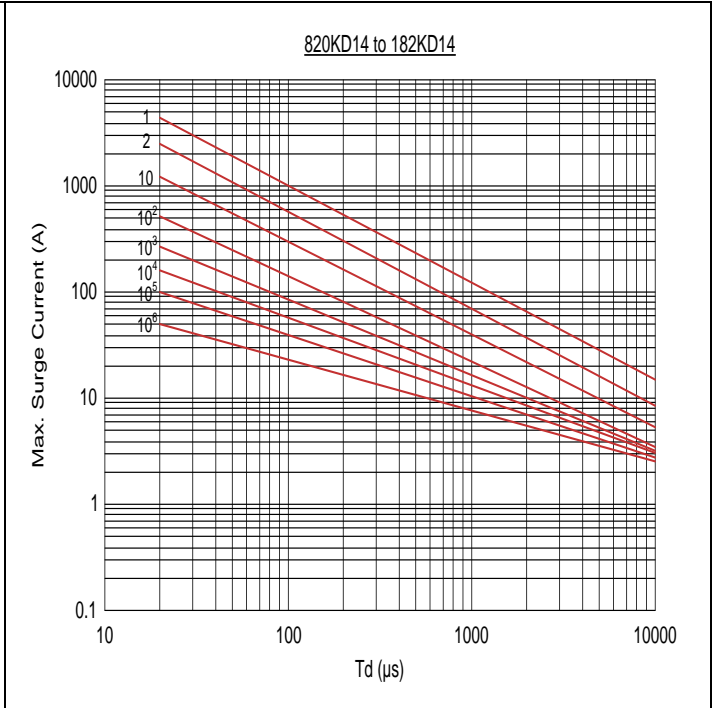
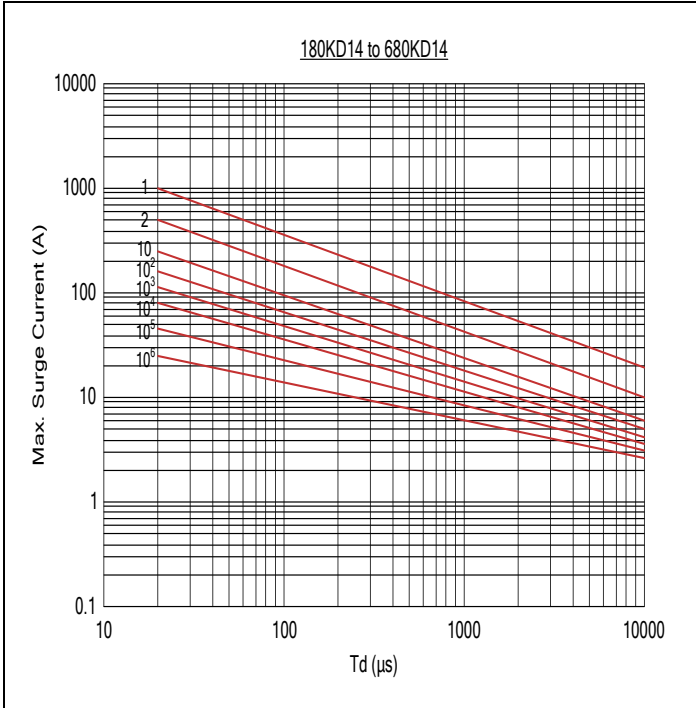

Maximum Leakage Current and Maximum Clamping Voltage Curve

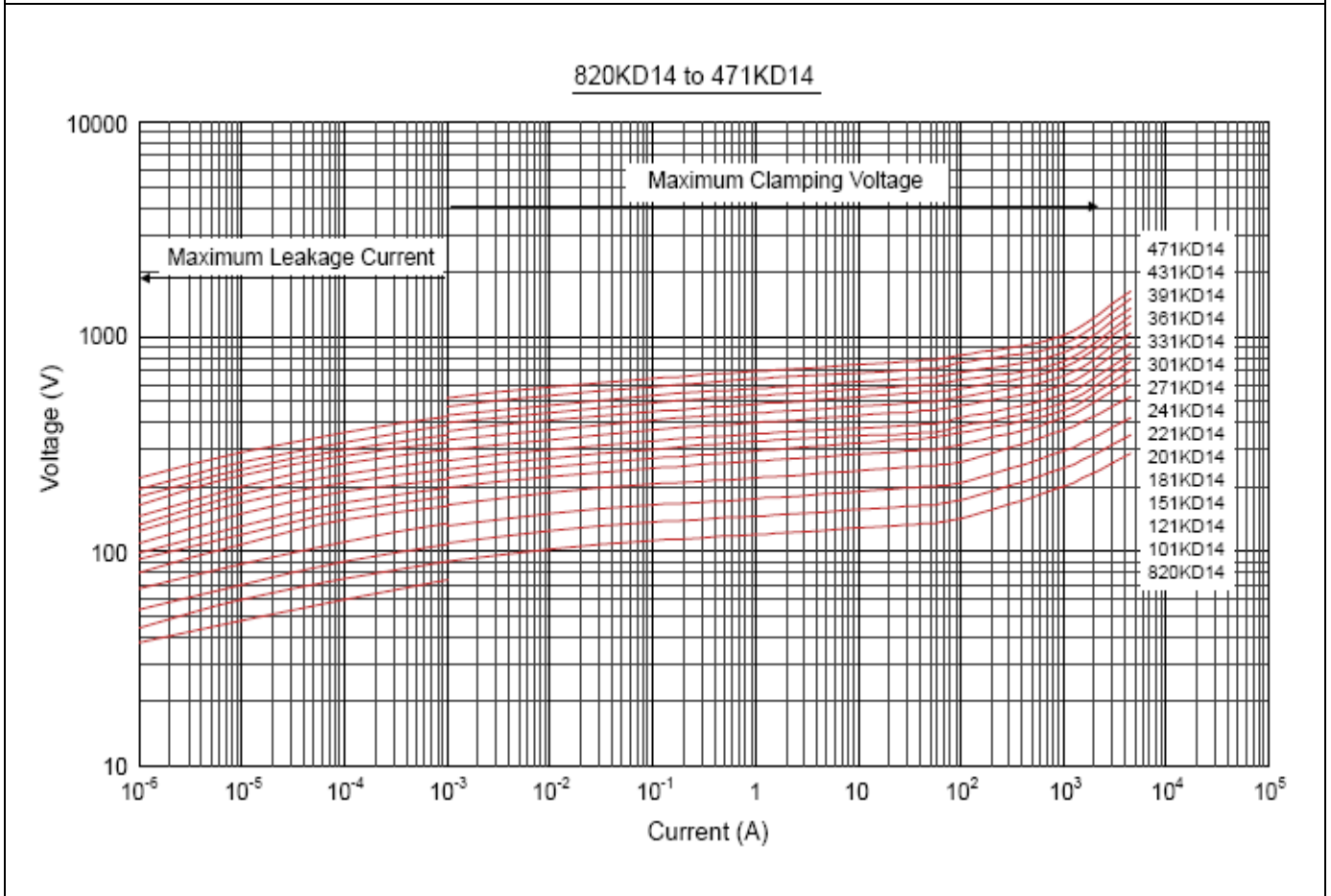
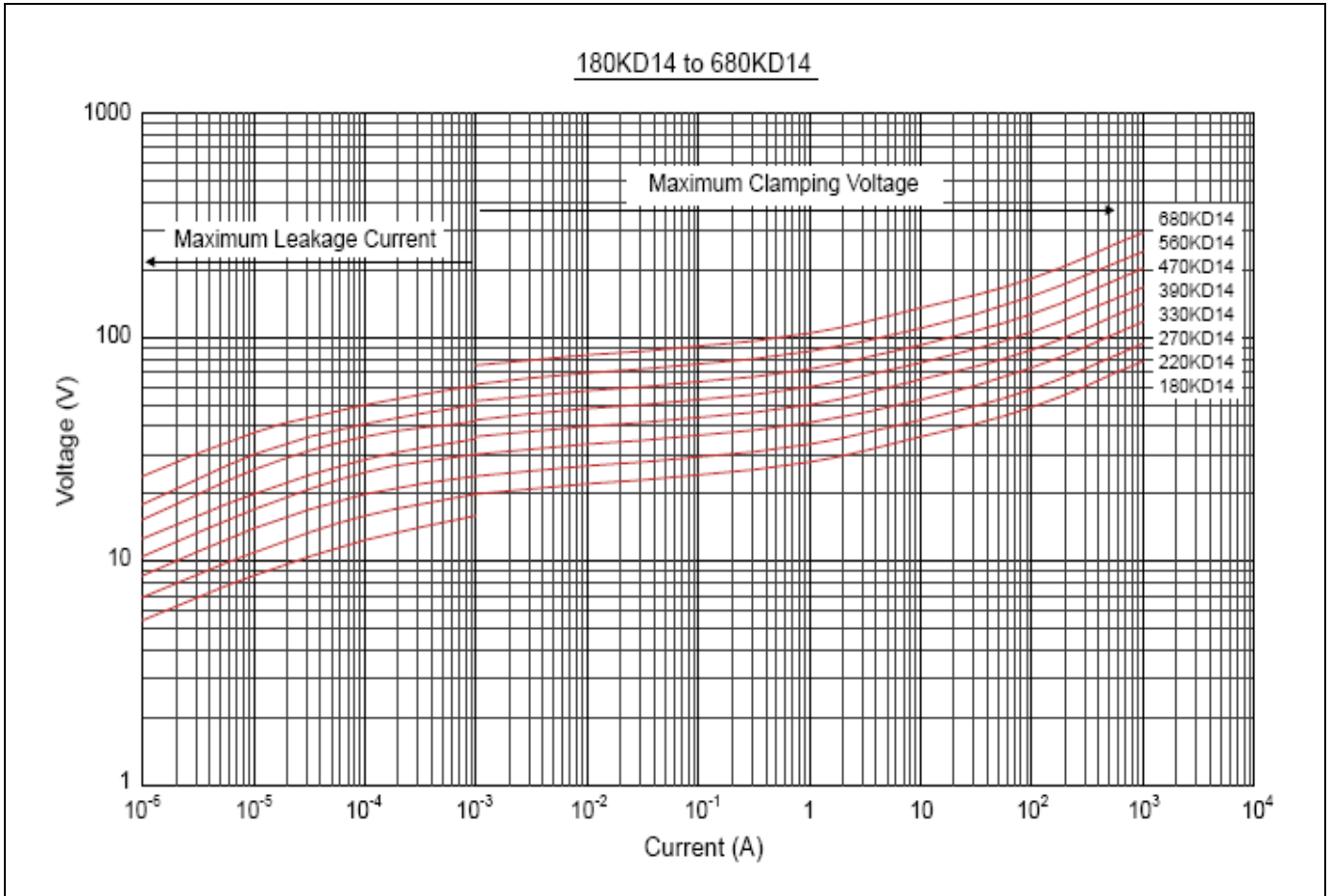

**Maximum Leakage Current and Maximum Clamping Voltage Curve**

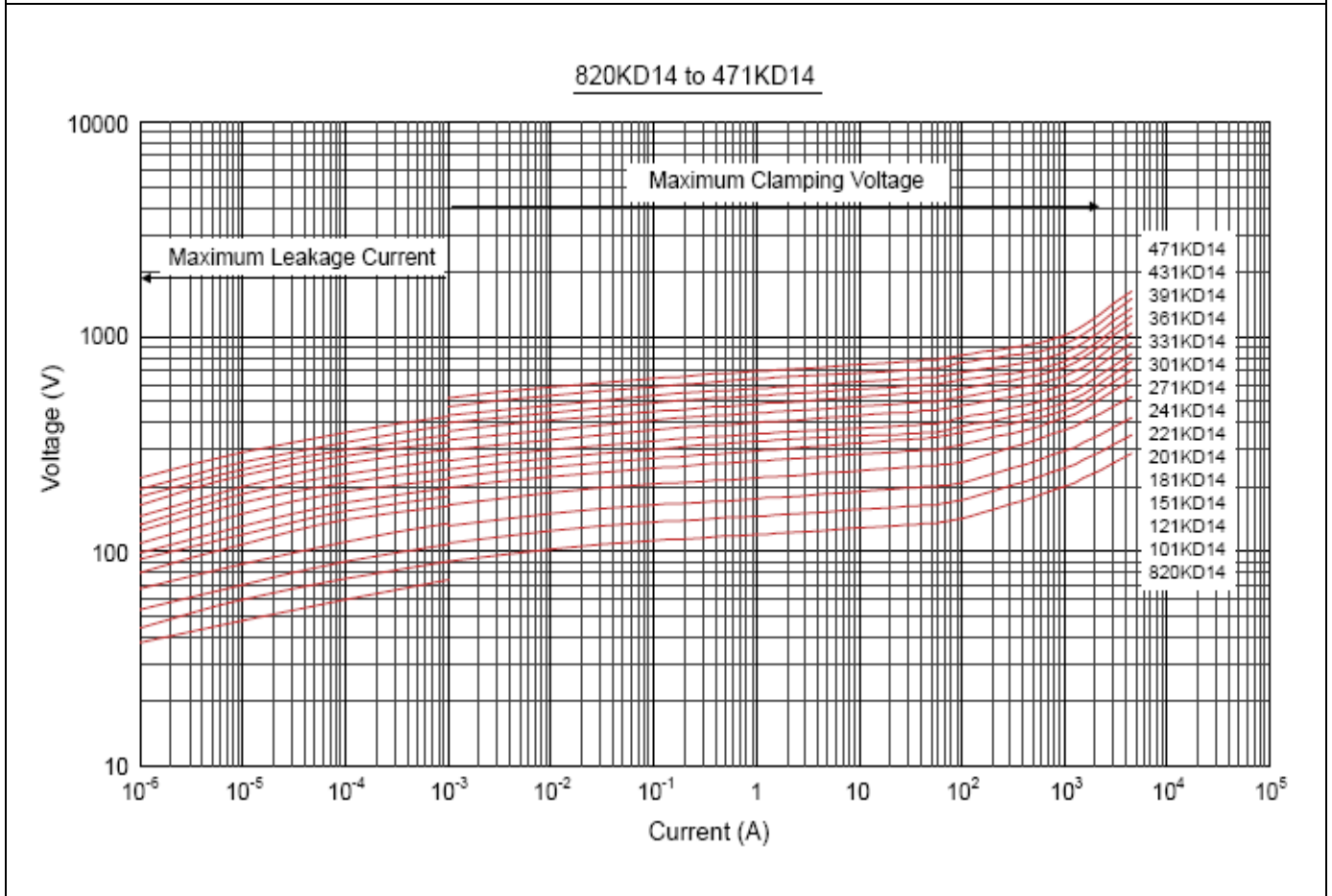
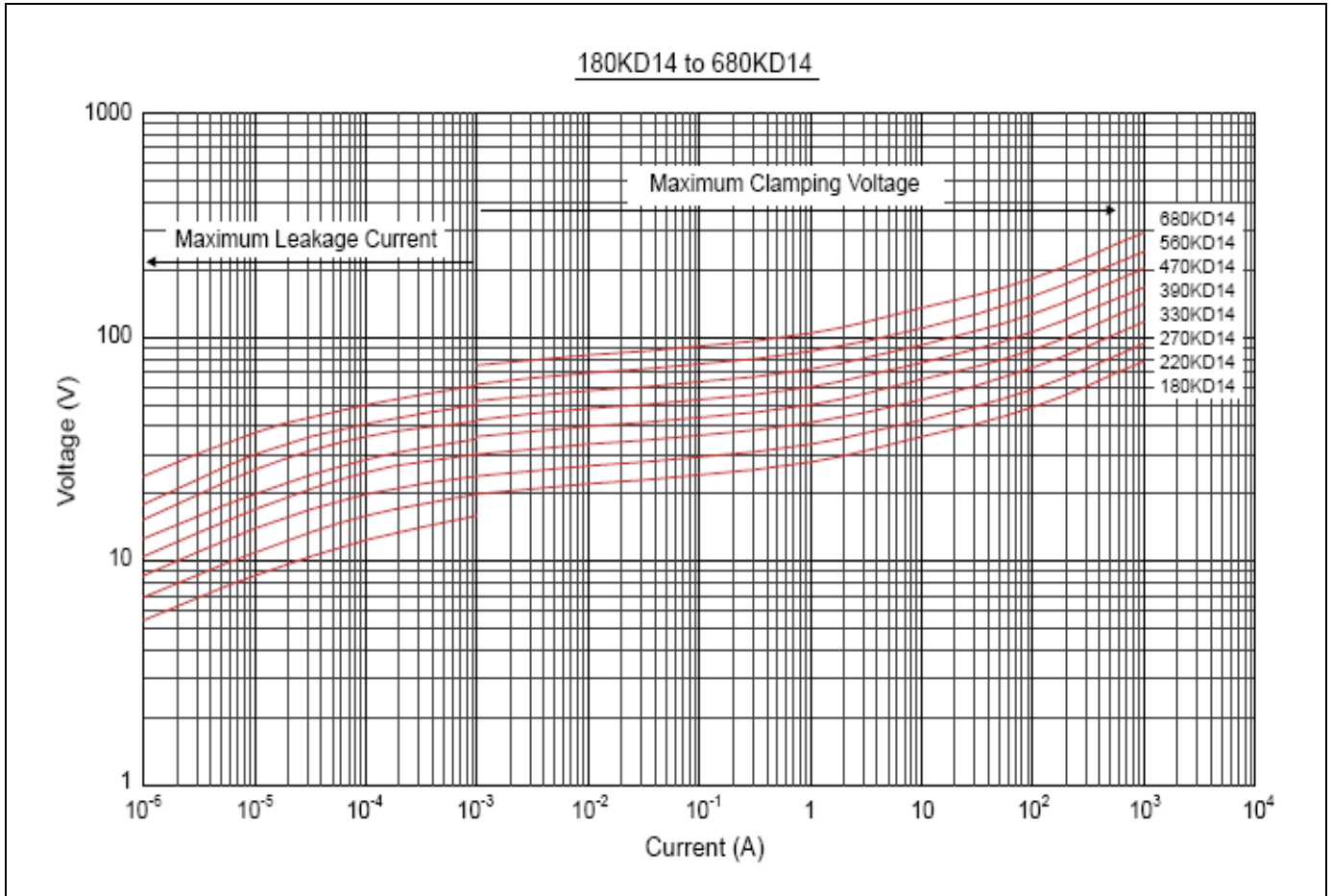

Maximum Leakage Current and Maximum Clamping Voltage Curve

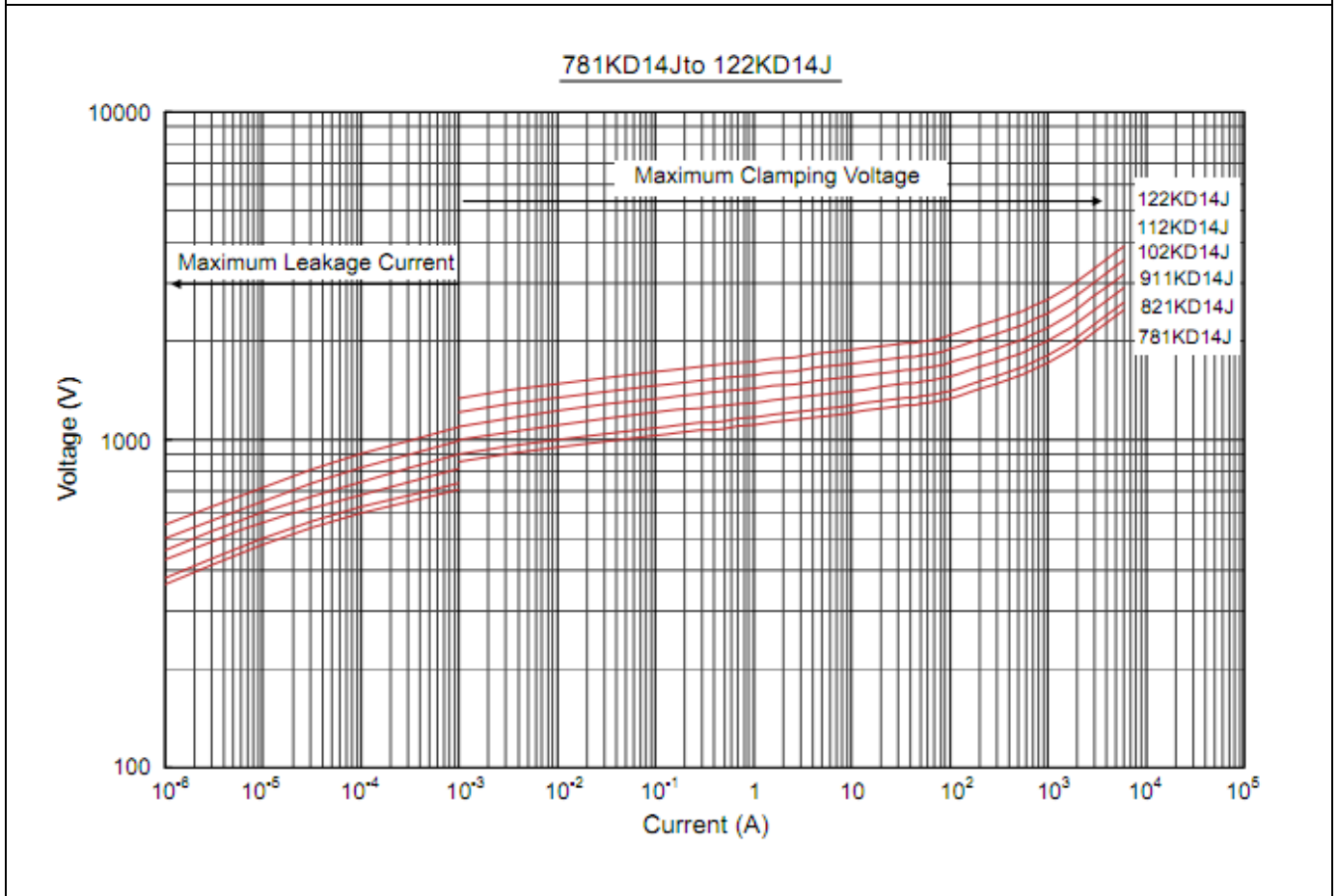
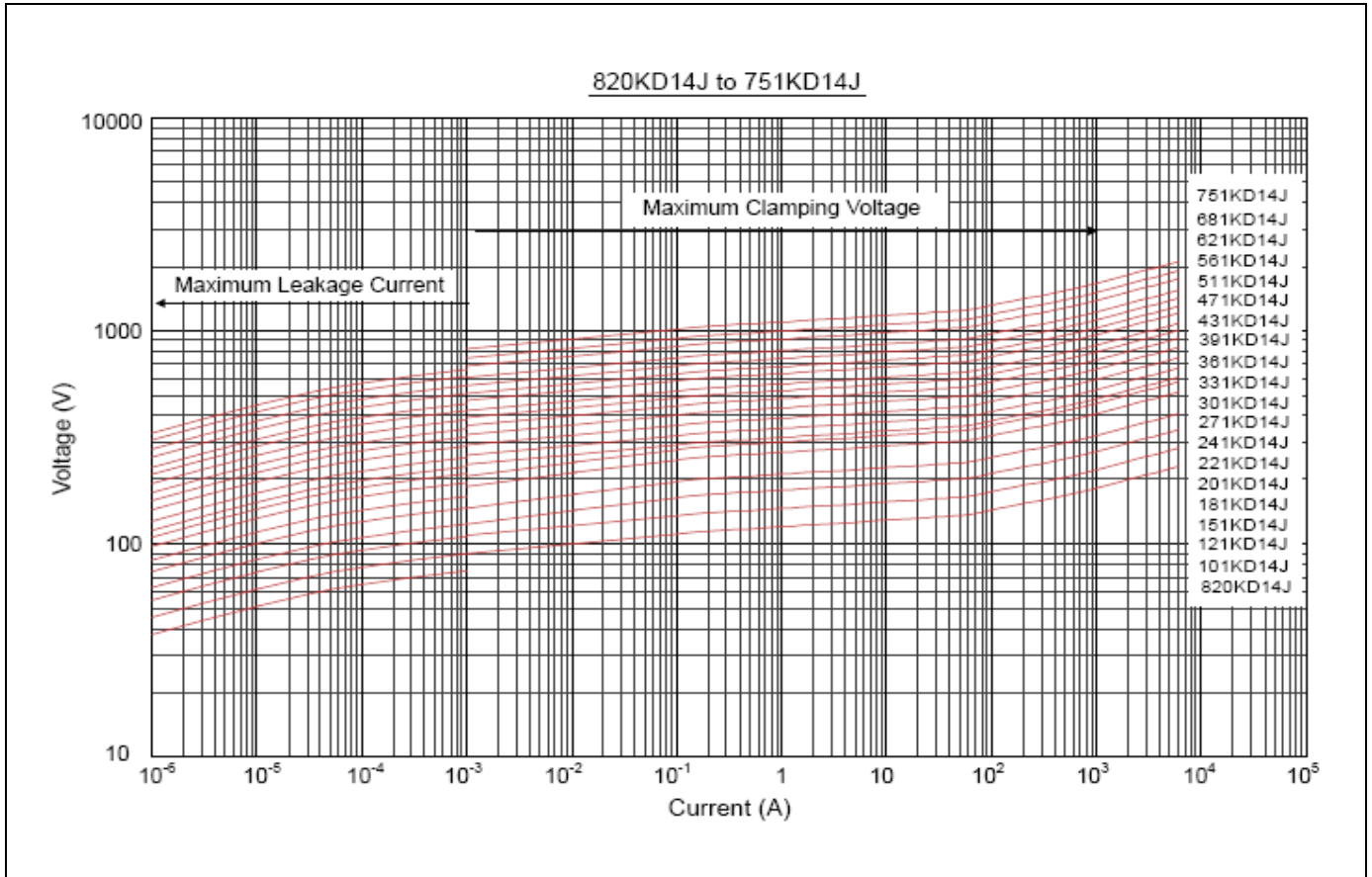



**Reliability**

Items	Standard	Test conditions / Methods	Specifications															
Tensile Strength of Terminals	IEC60068-2-21	Gradually applying the force specified and keeping the unit fixed for 10±1 sec.  <table border="1" style="margin-left: auto; margin-right: auto;"> <thead> <tr> <th>Terminal diameter (mm)</th> <th>Force (kg)</th> </tr> </thead> <tbody> <tr> <td>0.5 &lt; d ≤ 0.8</td> <td>1.0</td> </tr> <tr> <td>0.8 &lt; d ≤ 1.25</td> <td>2.0</td> </tr> <tr> <td>1.25 &lt; d</td> <td>4.0</td> </tr> </tbody> </table>	Terminal diameter (mm)	Force (kg)	0.5 < d ≤ 0.8	1.0	0.8 < d ≤ 1.25	2.0	1.25 < d	4.0	No visible damage  ΔV <sub>1mA</sub> /V <sub>1mA</sub>   ≤ 5%							
Terminal diameter (mm)	Force (kg)																	
0.5 < d ≤ 0.8	1.0																	
0.8 < d ≤ 1.25	2.0																	
1.25 < d	4.0																	
Bending Strength of Terminals	IEC60068-2-21	Hold specimen and apply the force specified below to each lead. Bend the specimen to 90°, then return to the original position. Repeat the procedure in the opposite direction.  <table border="1" style="margin-left: auto; margin-right: auto;"> <thead> <tr> <th>Terminal diameter (mm)</th> <th>Force (kg)</th> </tr> </thead> <tbody> <tr> <td>0.5 &lt; d ≤ 0.8</td> <td>0.5</td> </tr> <tr> <td>0.8 &lt; d ≤ 1.25</td> <td>1.0</td> </tr> <tr> <td>1.25 &lt; d</td> <td>2.0</td> </tr> </tbody> </table>	Terminal diameter (mm)	Force (kg)	0.5 < d ≤ 0.8	0.5	0.8 < d ≤ 1.25	1.0	1.25 < d	2.0	No visible damage  ΔV <sub>1mA</sub> /V <sub>1mA</sub>   ≤ 5%							
Terminal diameter (mm)	Force (kg)																	
0.5 < d ≤ 0.8	0.5																	
0.8 < d ≤ 1.25	1.0																	
1.25 < d	2.0																	
Vibration	IEC60068-2-6	Frequency range: 10~55 Hz Amplitude: 0.75mm or 98m/s <sup>2</sup> Direction: 3 mutually perpendicular directions, 2hrs each.	No visible damage  ΔV <sub>1mA</sub> /V <sub>1mA</sub>   ≤ 5%															
Solderability	IEC60068-2-20	Solder Temp: 245±5°C Dipping Time: 2±0.5 sec	At least 95% of terminal electrode is covered by new solder															
Resistance to Soldering Heat	IEC60068-2-20	Solder Temp: 260±5°C Dipping Time: 10±1 sec	No visible damage  ΔV <sub>1mA</sub> /V <sub>1mA</sub>   ≤ 5%															
High Temperature Storage	IEC60068-2-2	Ambient Temp: 125±2°C Duration: 1000±24hrs	No visible damage  ΔV <sub>1mA</sub> /V <sub>1mA</sub>   ≤ 5%															
Low Temperature Storage	IEC60068-2-1	Ambient Temp: -40±2°C Duration: 1000±24hrs	No visible damage  ΔV <sub>1mA</sub> /V <sub>1mA</sub>   ≤ 5%															
Damp Heat, Steady State	IEC60068-2-78	The test is divided into two groups . a. 40±2°C , 90~95% RH for 1344±24hrs b. 40±2°C , 90~95% RH, at 10%VDC , 1344±24 hrs	No visible damage  ΔV <sub>1mA</sub> /V <sub>1mA</sub>   ≤ 10% Insulation Resistance ≥ 100MΩ															
High Temperature Load	MIL-STD-202 Method 108	Ambient Temp: 105±2°C    Duration: 1000±24hrs Load: Max. Allowable Voltage In AC.	ΔV <sub>1mA</sub> /V <sub>1mA</sub>   ≤ 10%															
Temperature Cycle	IEC60068-2-14	The conditions shown below shall be repeated 5 cycles <table border="1" style="margin-left: auto; margin-right: auto;"> <thead> <tr> <th>Step</th> <th>Temperature (°C)</th> <th>Period (minutes)</th> </tr> </thead> <tbody> <tr> <td>1</td> <td>-40±3</td> <td>30±3</td> </tr> <tr> <td>2</td> <td>Room temperature</td> <td>5±3</td> </tr> <tr> <td>3</td> <td>125±3</td> <td>30±3</td> </tr> <tr> <td>4</td> <td>Room temperature</td> <td>5±3</td> </tr> </tbody> </table>	Step	Temperature (°C)	Period (minutes)	1	-40±3	30±3	2	Room temperature	5±3	3	125±3	30±3	4	Room temperature	5±3	No visible damage  ΔV <sub>1mA</sub> /V <sub>1mA</sub>   ≤ 5%
Step	Temperature (°C)	Period (minutes)																
1	-40±3	30±3																
2	Room temperature	5±3																
3	125±3	30±3																
4	Room temperature	5±3																
8/20uS Surge Life	IEC61051-1	8/20μS waveform, 10 surge currents, unipolar, interval 30secs, amplitude corresponding to max. surge current derating curves for 20μS.	No visible damage ΔV <sub>b(1mA)</sub> ≤ ±10%															
10/1000μS Surge Life	IEC61051-1	10/1000μS waveform, 10 surge currents, unipolar, interval 2mins, amplitude corresponding to max. surge current derating curves for 1000μS.	No visible damage  ΔV <sub>1mA</sub> /V <sub>1mA</sub>   ≤ 10%															
Voltage Proof	IEC61051-1	Metal balls method, 2500Vac 1 min.	No visible damage															

**Soldering Recommendation**

Lead-free Wave Soldering Recommendation

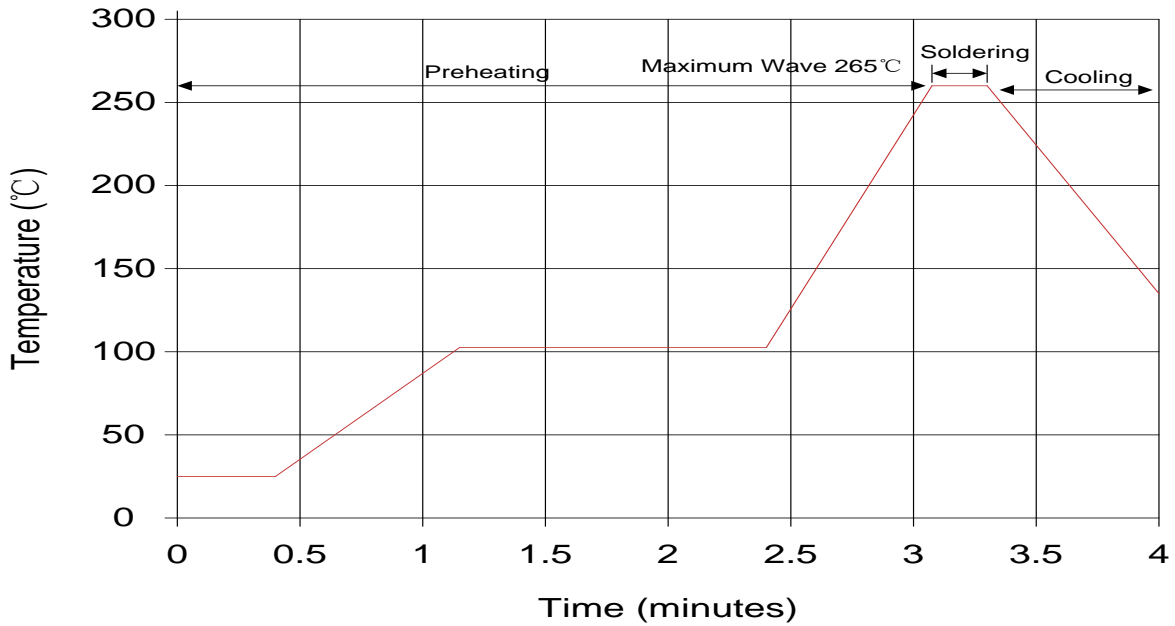

Item	Conditions
Peak Temperature	265°C
Dipping Time	10 seconds (max.)
Soldering	1 time

Recommendation Reworking Conditions with Soldering Iron

Item	Conditions
Temperature of Soldering Iron-tip	360°C (max.)
Soldering Time	3 seconds (max.)
Distance from Varistor	2mm (min.)

**Marking Code**

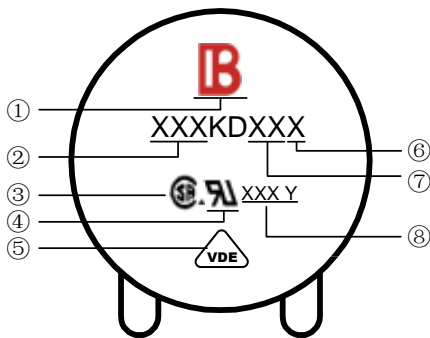

- ① Brightking Logo
- ② Varistor Voltage
- ③ CSA Accreditation Logo
- ④ UL Accreditation Logo
- ⑤ VDE Accreditation Logo
- ⑥ “J” is High Surge Code, no “J” is Standard Surge
- ⑦ Disk Size
- ⑧ Internal control code

**Taping Dimensions**

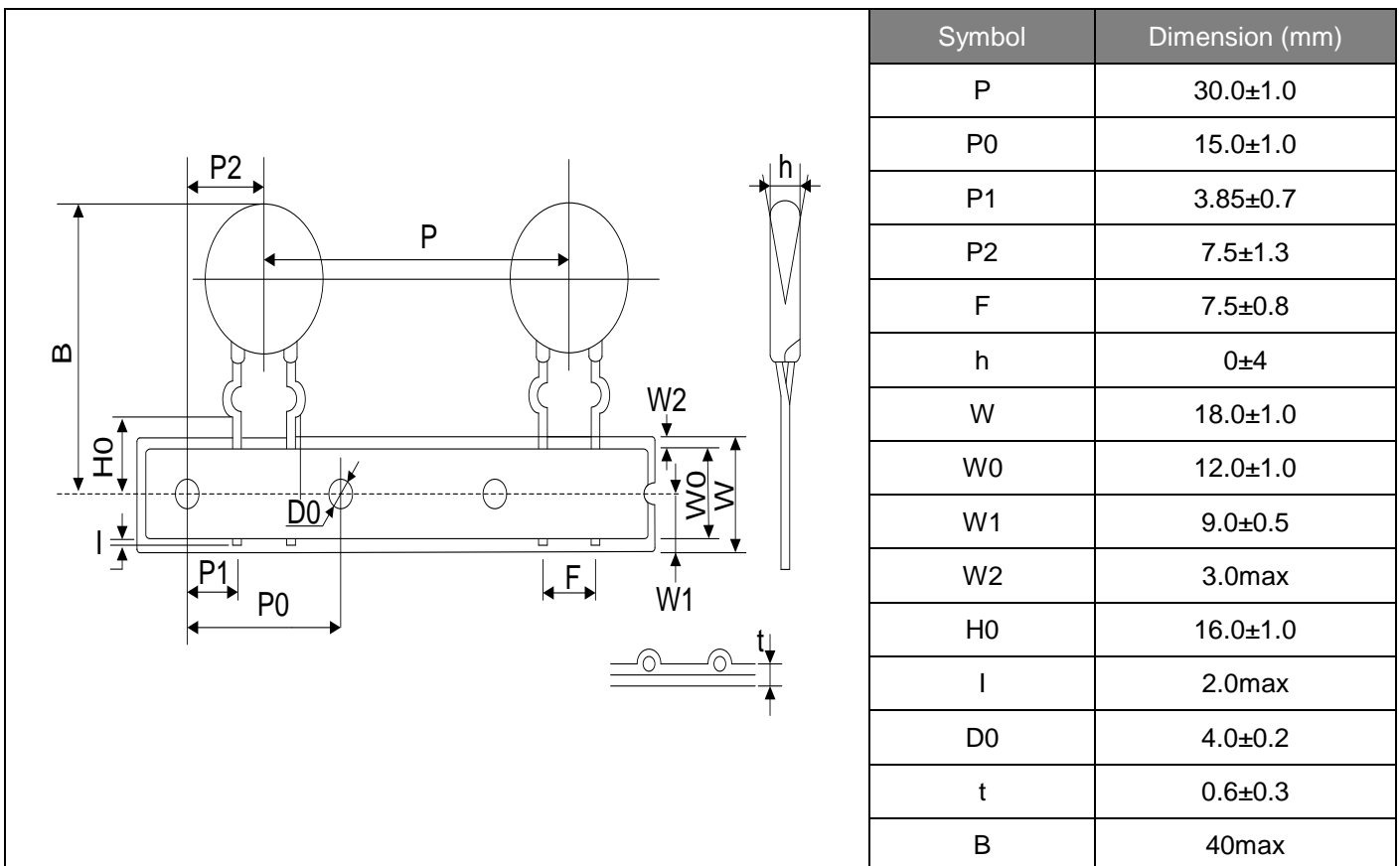
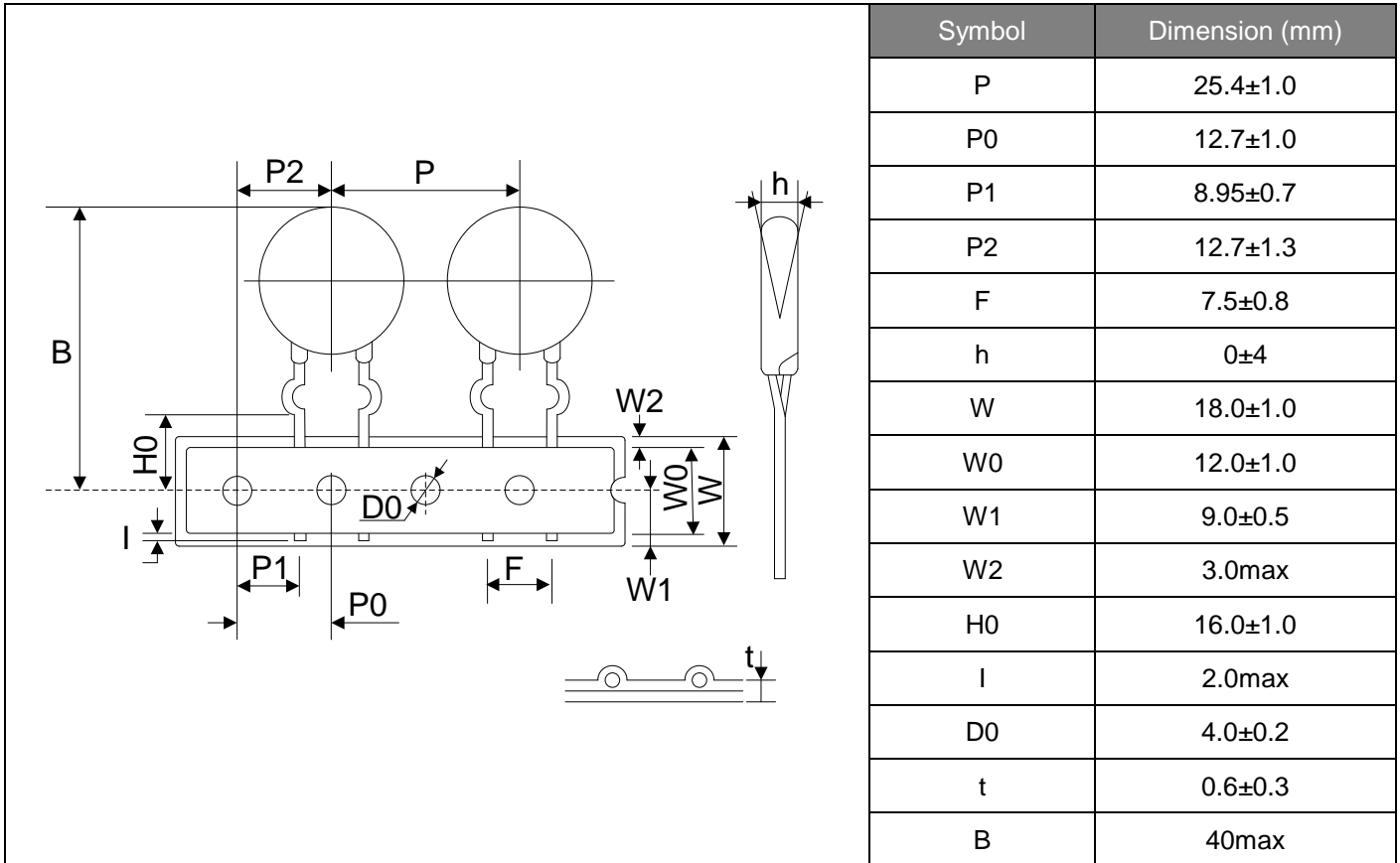

**Taping Dimensions**

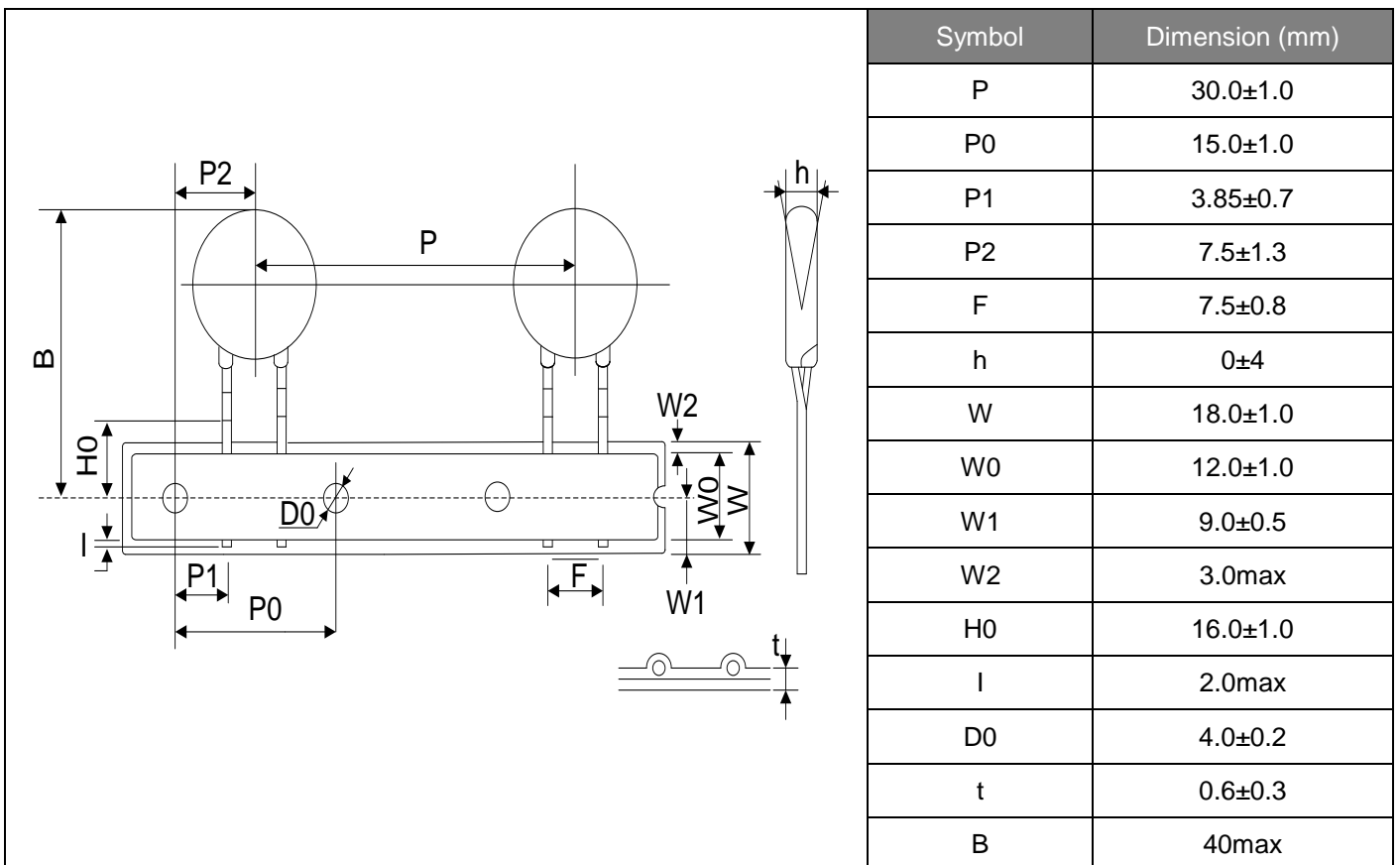
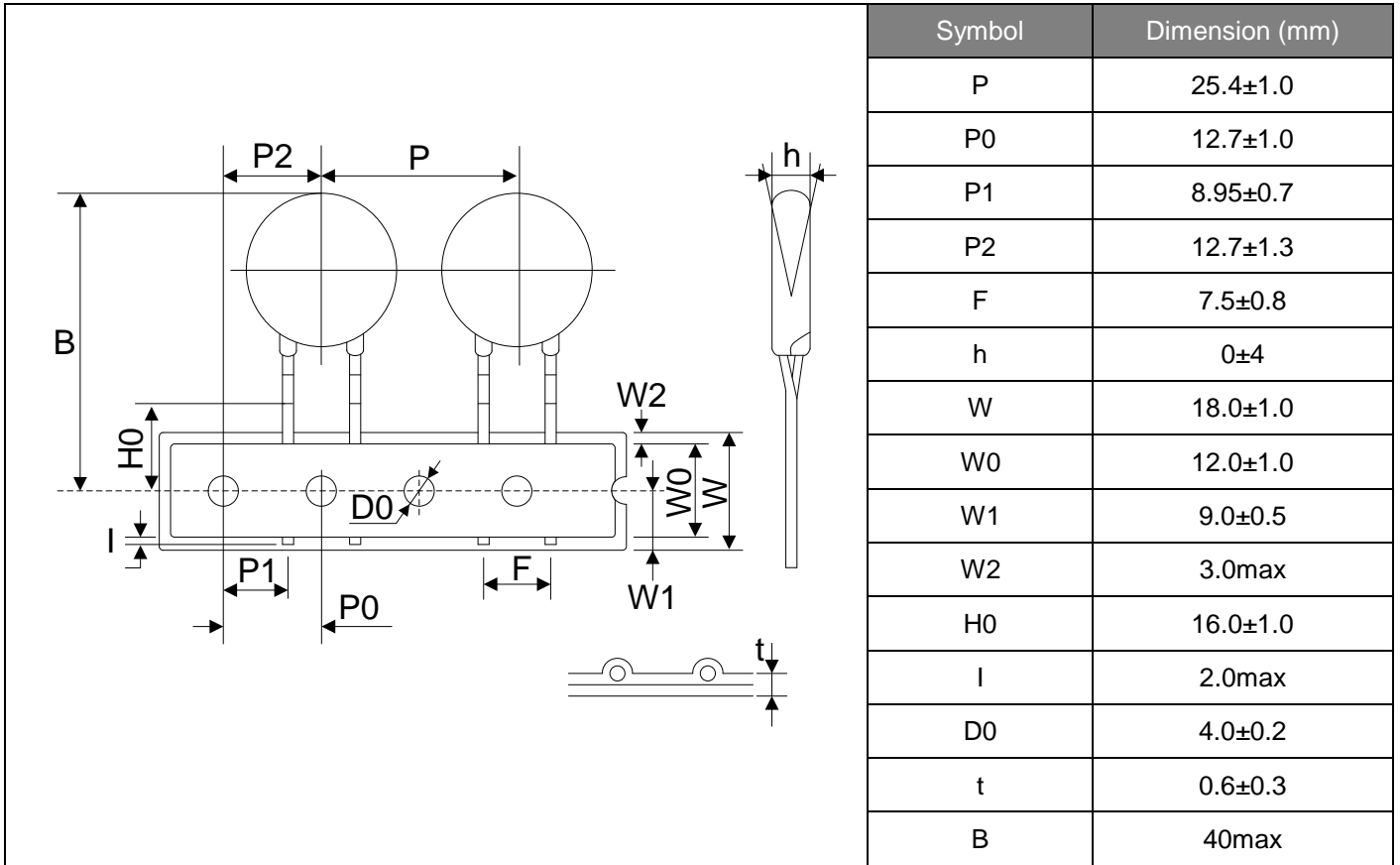

**Taping Dimensions**

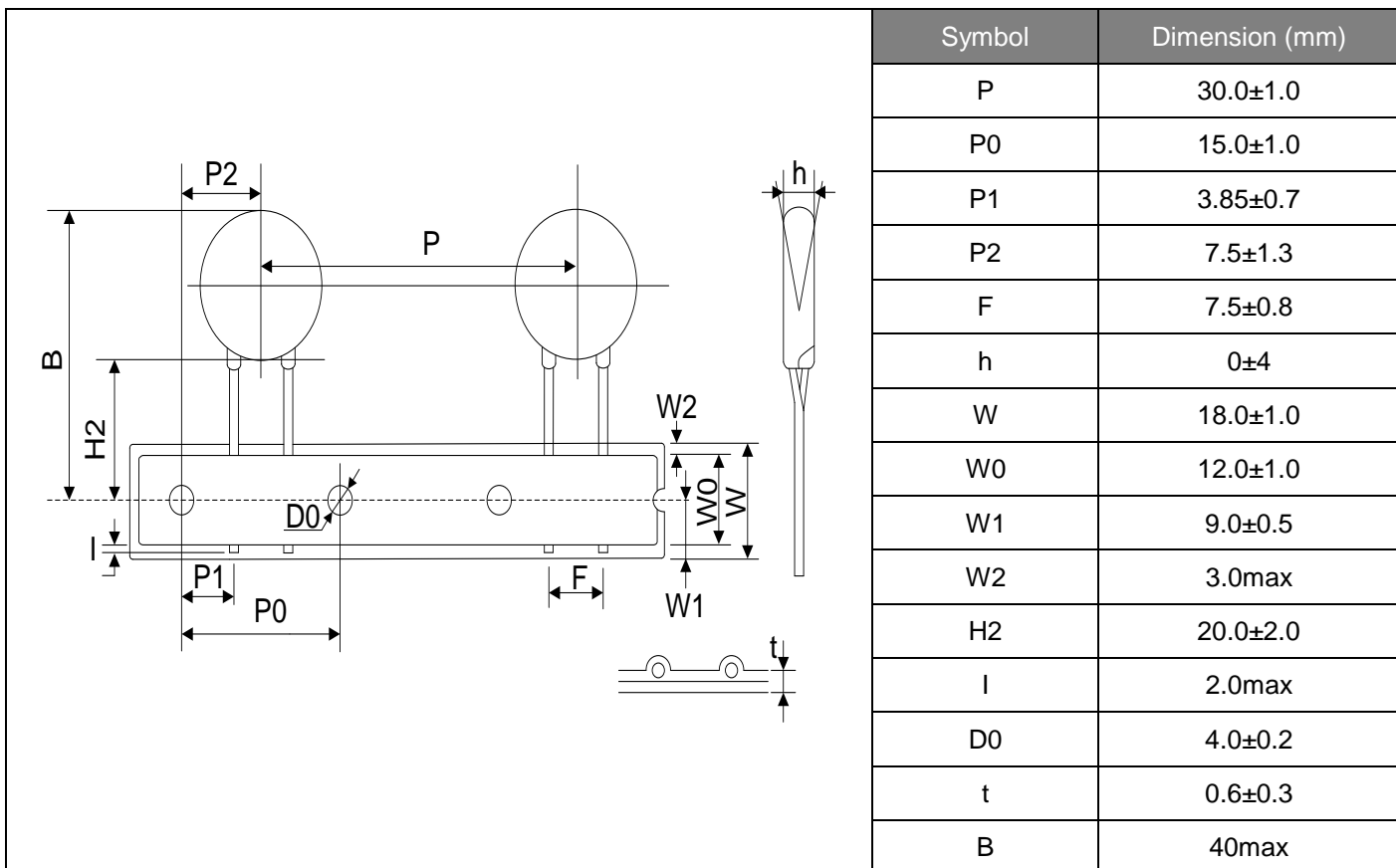
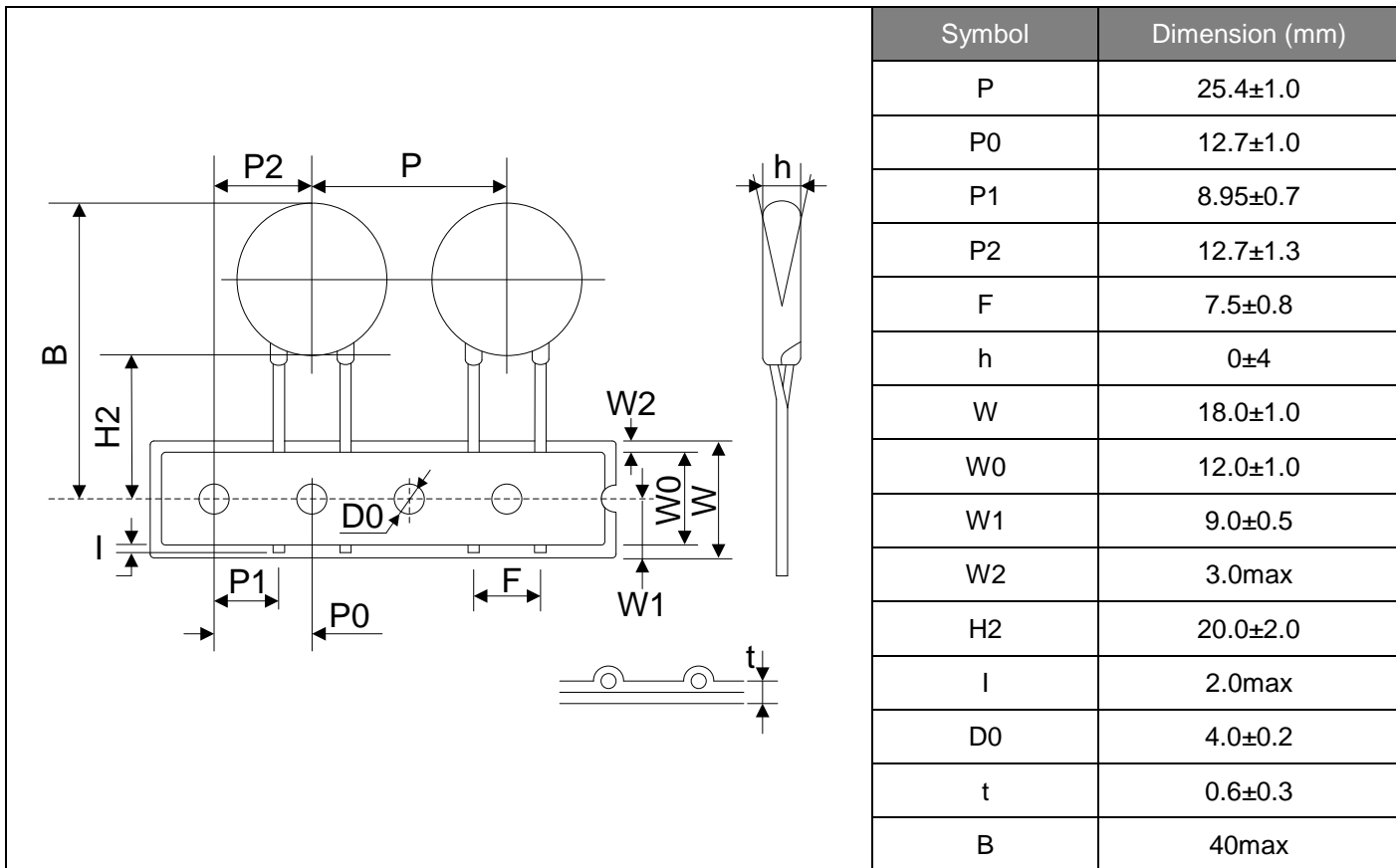

**Quantity**

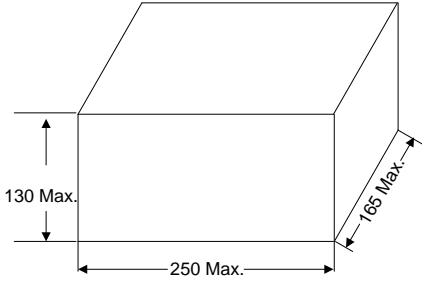
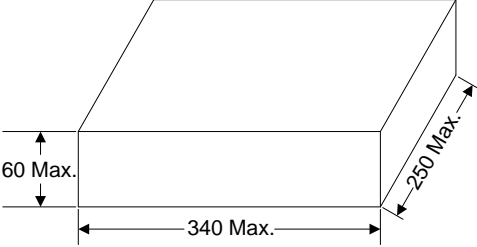
Packaging Dimensions (Unit: mm)	Quantity
<p>In bulk for Terminals Untrimmed Products</p> 	400pcs/bag 4bags/box (180K~331K)
	300pcs/bag 4bags/box (361K~621K)
	250pcs/bag 4bags/box (681K~112K)
	150pcs/bag 4bags/box (122K~182K)
<p>In bulk for Terminals Trimmed Products</p> 	400pcs/bag 4bags/box (180K~331K)
	300pcs/bag 4bags/box (361K~621K)
	250pcs/bag 4bags/box (681K~112K)
	150pcs/bag 4bags/box (122K~182K)
Packaging Dimensions (Unit: mm)	Quantity
<p>Tape &amp; Box &amp; P0=12.7mm</p> 	750pcs/ box (180K~241K)
	600pcs/ box (271K~331K)
	500pcs/ box (361K~621K)
	400pcs/ box (681K~751K)
	350pcs/ box (781K~112K)

**Quantity**

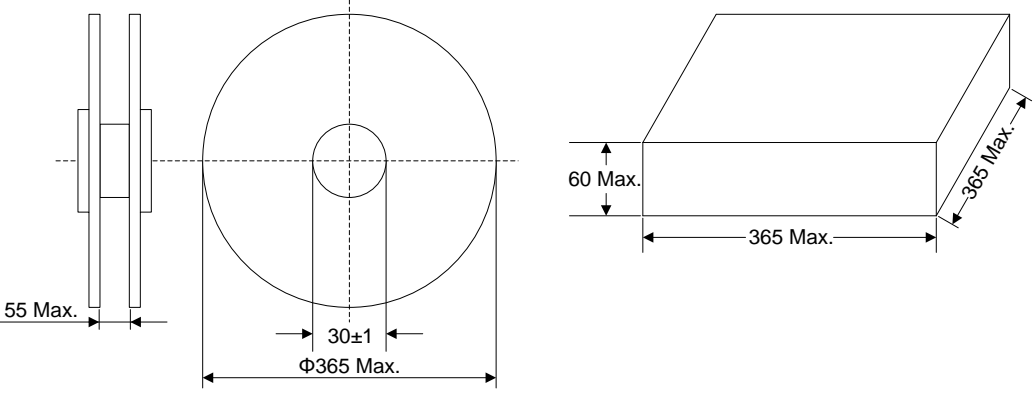
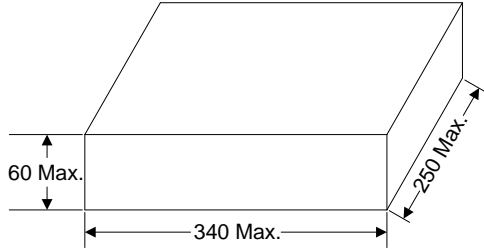
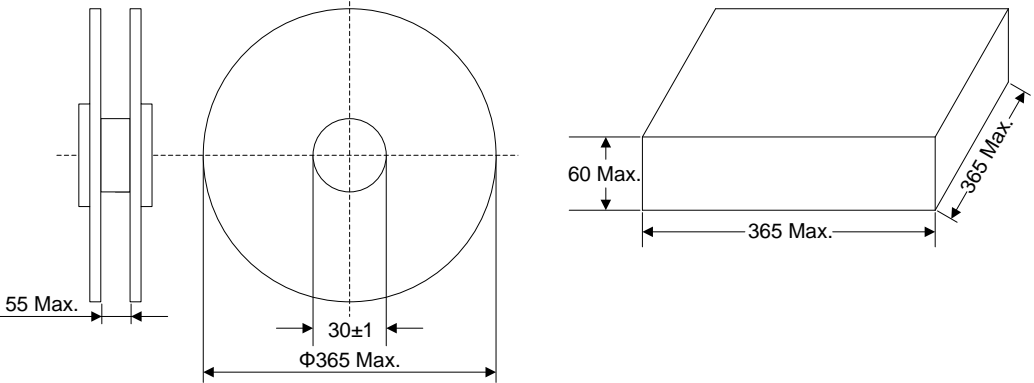
Packaging Dimensions (Unit: mm)	Quantity
<p><b>Tape &amp; Reel &amp; P0=12.7mm</b></p> 	<p>1000pcs/reel (180K~331K)</p> <p>750pcs/reel (361K~621K)</p> <p>500pcs/reel (681K~751K)</p> <p>400pcs/reel (781K~112K)</p>
<p><b>Packaging Dimensions (Unit: mm)</b></p> <p><b>Tape &amp; Box &amp; P0=15.0mm</b></p> 	<p>Quantity</p> <p>500pcs/ box (180K~331K)</p> <p>400pcs/ box (361K~751K)</p> <p>300pcs/ box (781K~112K)</p>
<p><b>Tape &amp; Reel &amp; P0=15.0mm</b></p> 	<p>750pcs/reel (180K~331K)</p> <p>600pcs/reel (361K~751K)</p> <p>500pcs/reel (781K~112K)</p>

## Storage Condition of Products

### (I) Storage Conditions :

- 1.Storage Temperature :  $-10^{\circ}\text{C} \sim +40^{\circ}\text{C}$
- 2.Relative Humidity :  $\leq 80\%RH$
- 3.Keep away from corrosive atmosphere and sunlight.

### (II) Period of Storage : 1 year



## X-ON Electronics

Largest Supplier of Electrical and Electronic Components

*Click to view similar products for [Varistors](#) category:*

*Click to view products by [Yageo](#) manufacturer:*

Other Similar products are found below :

[820443211E](#) [MOV05131AIA](#) [MOV07231AQA](#) [MOV18131CZA](#) [R71ZOV151HC](#) [D58ZOV500RA01T1](#) [B72205S271K111](#)  
[B72214S110K151](#) [B72214S251K151](#) [B72232B131K1](#) [B72530E1140S272](#) [B72540E250K62](#) [B72660M0271K093](#) [NTE1V020](#) [NTE1V130](#)  
[NTE2V010](#) [NTE2V130](#) [25FN511K](#) [S10K11G5S5](#) [ERZ-C14DK361U](#) [ERZ-C20DK221U](#) [ERZ-C32CK201B](#) [207869-1](#) [AS-13](#)  
[TMOV25SP625E](#) [TND10V-471KB00AAA0](#) [B72210S251K531](#) [B72214S200K551](#) [B72280B112K1](#) [B72280B381K1](#) [B72590D360A60](#)  
[B72650M301K93](#) [B72670M1140K72](#) [MOV07251ARA](#) [MOV10131EDA](#) [MOV10151EFA](#) [MOV14151CWA](#) [MOV20251DFA](#)  
[TVZ18EC271KBS](#) [TVZ20EB911KBS](#) [TVZ25D201KBS](#) [TVZ25D241KBS](#) [VDRH20X230BSE](#) [VZ07D220KBS](#) [VZ40D241K](#)  
[VZ25D511KBS-N](#) [VZ20E511KBSX](#) [VZ20E221KBSX](#) [VZ10D471KBS-N](#) [ERZ-V20R201](#)