

DATA SHEET

ANTI-SULFURATED CHIP RESISTORS AUTOMOTIVE GRADE

AF series

5%, 1%, 0.5%

sizes 0100/0201/0402/0603/0805/1206/1210/1218/2010/2512

RoHS compliant & Halogen free



SCOPE

This specification describes AF0100 to AF2512 chip resistors with anti-sulfuration capabilities.

APPLICATIONS

- Industrial Equipment
- Power Application
- Networking Application
- High-end Computer & Multimedia Electronics in high sulfur environment
- Automotive electronics

FEATURES

- AEC-Q200 qualified for size 0201~2512
- Superior resistance against sulfur containing atmosphere
- Halogen free product and production
- RoHS compliant
- Reduces environmentally hazardous waste
- High component and equipment reliability
- Saving of PCB space
- Moisture sensitivity level: MSL 1
- 50ppm available

ORDERING INFORMATION - GLOBAL PART NUMBER

Part number is identified by the series name, size, tolerance, packaging type, temperature coefficient, taping reel and resistance value.

GLOBAL PART NUMBER

AF XXXX X X X XX XXXX L
 (1) (2) (3) (4) (5) (6) (7)

(1) SIZE

0100/0201/0402/0603/0805/1206/1210/1218/2010/2512

(2) TOLERANCE

- D = ±0.5%
- F = ±1%
- J = ±5% (for jumper ordering, use code of J)

(3) PACKAGING TYPE

- R = Paper taping reel
- K = Embossed plastic tape reel

(4) TEMPERATURE COEFFICIENT OF RESISTANCE

- = Base on spec
- E = ±50 ppm/°C

(5) TAPING REEL

- 07 = 7 inch dia. Reel
- 13 = 13 inch dia. Reel
- 7W = 7 inch dia. Reel & 2 x standard power

(6) RESISTANCE VALUE

There are 2~4 digits indicated the resistance value. Letter R/K/M is decimal point. Detailed resistance rules are displayed in the table of "Resistance rule of global part number".

(7) DEFAULT CODE

Letter L is system default code for ordering only ^(Note)

Resistance rule of global part number	
Resistance coding rule	Example
XRXX (1 to 9.76 Ω)	1R = 1 Ω 1R5 = 1.5 Ω 9R76 = 9.76 Ω
XXRX (10 to 97.6 Ω)	10R = 10 Ω 97R6 = 97.6 Ω
XXXX (100 to 976 Ω)	100R = 100 Ω
XKXX (1 to 9.76 KΩ)	1K = 1,000 Ω 9K76 = 9760 Ω
XMXX (1 to 9.76 MΩ)	1M = 1,000,000 Ω 9M76 = 9,760,000 Ω

ORDERING EXAMPLE

The ordering code for an AF0402 chip resistor, value 100 KΩ with ±1% tolerance, supplied in 7-inch tape reel with 10Kpcs quantity is: AF0402FR-07100KL.

NOTE

1. All our R-Chip products are RoHS compliant and Halogen free. "LFP" of the internal 2D reel label states "Lead-Free Process"
2. On customized label, "LFP" or specific symbol can be printed

MARKING

AF0100 / AF0201 / AF0402



AF0603 / AF0805 / AF1206 / AF1210 / AF2010 / AF2512

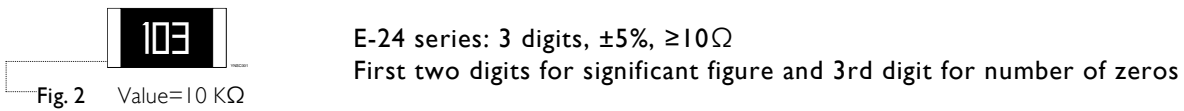

AF0603

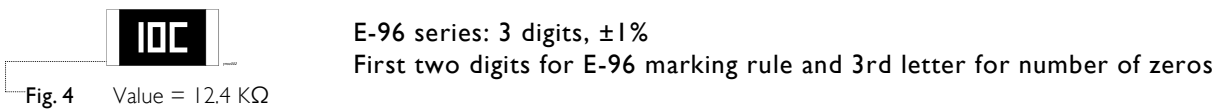
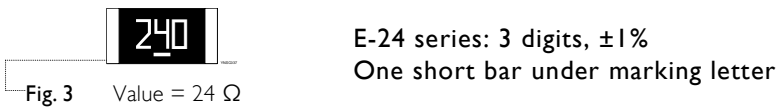

AF0805 / AF1206 / AF1210 / AF2010 / AF2512

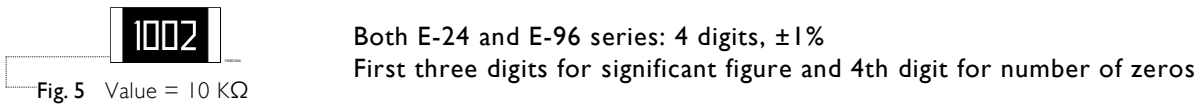

AF1218

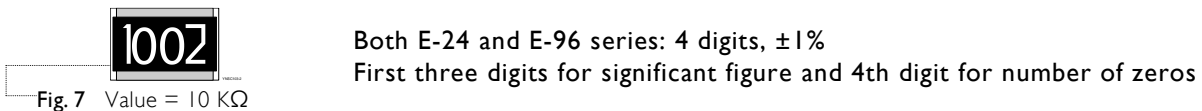
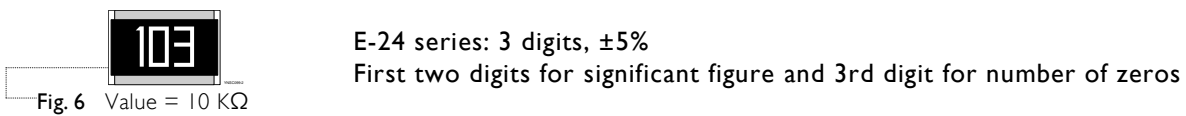

NOTE

For further marking information, please see special data sheet “Chip resistors marking”. Marking of AF series is the same as RC series

CONSTRUCTION

The resistors are constructed on top of a high grade ceramic body. Internal metal electrodes are added at each end and connected by a resistive glaze. The resistive glaze is covered by a glass.

The composition of the glaze is adjusted to give the approximate required resistance value and laser trimming of this resistive glaze achieves the value within tolerance.

The whole element is covered by a protective overcoat. Size 0603 and bigger is marked with the resistance value on top. Finally, the two external terminations (Ni / matte tin) are added. See fig.8

DIMENSIONS

Table I For outlines see fig. 8

TYPE	L (mm)	W (mm)	H (mm)	I ₁ (mm)	I ₂ (mm)
AF0100	0.40±0.02	0.20±0.02	0.14±0.02	0.10±0.03	0.10±0.03
AF0201	0.60±0.03	0.30±0.03	0.23±0.03	0.12±0.05	0.15±0.05
AF0402	1.00±0.05	0.50±0.05	0.35±0.05	0.20±0.10	0.25±0.10
AF0603	1.60±0.10	0.80±0.10	0.45±0.10	0.25±0.15	0.25±0.15
AF0805	2.00±0.10	1.25±0.10	0.50±0.10	0.35±0.20	0.35±0.20
AF1206	3.10±0.10	1.60±0.10	0.55±0.10	0.45±0.20	0.50±0.20
AF1210	3.10±0.10	2.60±0.15	0.57±0.10	0.45±0.20	0.50±0.20
AF1218	3.10±0.10	4.60±0.10	0.57±0.10	0.45±0.20	0.50±0.20
AF2010	5.00±0.10	2.50±0.15	0.57±0.10	0.55±0.20	0.55±0.20
AF2512	6.35±0.10	3.20±0.15	0.57±0.10	0.60±0.20	0.60±0.20

OUTLINES

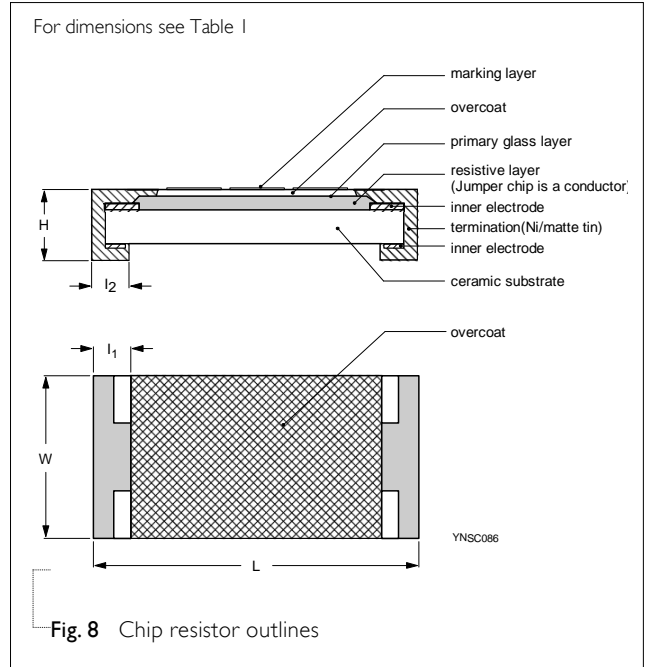

ELECTRICAL CHARACTERISTICS

Table 2

TYPE	POWER	CHARACTERISTICS						
		Operating Temperature Range	Max. Working Voltage	Max. Overload Voltage	Dielectric Withstanding Voltage	Resistance Range	Temperature Coefficient	Jumper Criteria
AF0100	1/32 W	-55 °C to 125°C	15V	30V	30V	5% (E24) 10Ω ≤ R ≤ 1MΩ	10Ω ≤ R < 100Ω ±300 ppm/°C	Rated Current 0.5A
						1% (E24/E96) 10Ω ≤ R ≤ 1MΩ Jumper < 50mΩ	100Ω ≤ R ≤ 1MΩ ±200 ppm/°C	Max. Current 1.0A
AF0201	1/20 W		25V	50V	50V	5% (E24) 1Ω ≤ R ≤ 10MΩ	1Ω ≤ R ≤ 10Ω -100/+350 ppm/°C	Rated Current 0.5A
						0.5%, 1% (E24/E96) 1Ω ≤ R ≤ 10MΩ Jumper < 50mΩ	10Ω < R ≤ 10MΩ ±200 ppm/°C	Max. Current 1.0A
AF0402	1/16 W		50V	100V	100V	5% (E24) 1Ω ≤ R ≤ 22MΩ	1Ω ≤ R ≤ 10Ω ±200 ppm/°C	Rated Current 1A
						0.5%, 1% (E24/E96) 1Ω ≤ R ≤ 10MΩ Jumper < 50mΩ	10Ω < R ≤ 10MΩ ±100 ppm/°C	Max. Current 2A
AF0603	1/8W		75V	100V	100V	5% (E24) 1Ω ≤ R ≤ 10MΩ	1Ω ≤ R < 10Ω ±200 ppm/°C	Rated Current 1A
						0.5%, 1% (E24/E96) 1Ω ≤ R ≤ 10MΩ	10Ω ≤ R ≤ 10MΩ ±100 ppm/°C	Max. Current 2A
AF0805	1/10 W		75V	150V	150V	5% (E24) 1Ω ≤ R ≤ 22MΩ	1Ω ≤ R < 10Ω ±200 ppm/°C	Rated Current 1A
						0.5%, 1% (E24/E96) 1Ω ≤ R ≤ 10MΩ Jumper < 50mΩ	10Ω ≤ R ≤ 10MΩ ±100 ppm/°C	Max. Current 2A
AF0805	1/5 W	-55 °C to 155 °C	75V	150V	150V	5% (E24) 1Ω ≤ R ≤ 10MΩ	1Ω ≤ R < 10Ω ±200 ppm/°C	Rated Current 2A
						0.5%, 1% (E24/E96) 1Ω ≤ R ≤ 10MΩ	10Ω ≤ R ≤ 10MΩ ±100 ppm/°C	Max. Current 5A
AF1206	1/8 W		150V	300V	300V	5% (E24) 1Ω ≤ R ≤ 22MΩ	1Ω ≤ R < 10Ω ±200 ppm/°C	Rated Current 2A
						0.5%, 1% (E24/E96) 1Ω ≤ R ≤ 10MΩ Jumper < 50mΩ	10Ω ≤ R ≤ 10MΩ ±100 ppm/°C	Max. Current 10A
AF1206	1/4 W		150V	300V	300V	5% (E24) 1Ω ≤ R ≤ 10MΩ	1Ω ≤ R < 10Ω ±200 ppm/°C	Rated Current 2A
						0.5%, 1% (E24/E96) 1Ω ≤ R ≤ 10MΩ	10Ω ≤ R ≤ 10MΩ ±100 ppm/°C	Max. Current 10A
AF1206	1/4 W		200V	400V	500V	5% (E24) 1Ω ≤ R ≤ 22MΩ	1Ω ≤ R < 10Ω ±200 ppm/°C	Rated Current 2A
						0.5%, 1% (E24/E96) 1Ω ≤ R ≤ 10MΩ Jumper < 50mΩ	10Ω ≤ R ≤ 10MΩ ±100 ppm/°C	Max. Current 10A
AF1206	1/2 W		200V	400V	500V	5% (E24) 1Ω ≤ R ≤ 10MΩ	1Ω ≤ R < 10Ω ±200 ppm/°C	Rated Current 2A
						0.5%, 1% (E24/E96) 1Ω ≤ R ≤ 10MΩ	10Ω ≤ R ≤ 10MΩ ±100 ppm/°C	Max. Current 10A

ELECTRICAL CHARACTERISTICS

Table 2

TYPE	POWER	CHARACTERISTICS						
		Operating Temperature Range	Max. Working Voltage	Max. Overload Voltage	Dielectric Withstanding Voltage	Resistance Range	Temperature Coefficient	Jumper Criteria
AF1210	1/2 W		200V	500V	500V	5% (E24) 1Ω ≤ R ≤ 10MΩ 0.5%, 1% (E24/E96) 1Ω ≤ R ≤ 10MΩ Jumper < 50mΩ	1Ω ≤ R < 10Ω ±200 ppm/°C 10Ω ≤ R ≤ 10MΩ ±100 ppm/°C 100Ω ≤ R ≤ 1MΩ ±50 ppm/°C	Rated Current 2A Max. Current 10A
	1 W		200V	500V	500V	5% (E24) 1Ω ≤ R ≤ 10MΩ 0.5%, 1% (E24/E96) 1Ω ≤ R ≤ 10MΩ	1Ω ≤ R < 10Ω ±200 ppm/°C 10Ω ≤ R ≤ 10MΩ ±100 ppm/°C	
AF1218	1 W		200V	500V	500V	5% (E24) 1Ω ≤ R ≤ 1MΩ 0.5%, 1% (E24/E96) 1Ω ≤ R ≤ 1MΩ Jumper < 50mΩ	1Ω ≤ R < 10Ω ±200 ppm/°C 10Ω ≤ R ≤ 1MΩ ±100 ppm/°C 100Ω ≤ R ≤ 2.2MΩ ±50 ppm/°C	Rated Current 2A Max. Current 10A
	1.5 W	-55 °C to 155 °C	200V	500V	500V	5% (E24) 1Ω ≤ R ≤ 1MΩ 0.5%, 1% (E24/E96) 1Ω ≤ R ≤ 1MΩ	1Ω ≤ R < 10Ω ±200 ppm/°C 10Ω ≤ R ≤ 1MΩ ±100 ppm/°C	
AF2010	3/4 W		200V	500V	500V	5% (E24) 1Ω ≤ R ≤ 10MΩ 0.5%, 1% (E24/E96) 1Ω ≤ R ≤ 10MΩ Jumper < 50mΩ	1Ω ≤ R < 10Ω ±200 ppm/°C 10Ω ≤ R ≤ 10MΩ ±100 ppm/°C 100Ω ≤ R ≤ 10MΩ ±50 ppm/°C	Rated Current 2A Max. Current 10A
	1.25W		200V	500V	500V	5% (E24) 1Ω ≤ R ≤ 10MΩ 0.5%, 1% (E24/E96) 1Ω ≤ R ≤ 10MΩ	1Ω ≤ R < 10Ω ±200 ppm/°C 10Ω ≤ R ≤ 10MΩ ±100 ppm/°C	
AF2512	1 W		200V	500V	500V	5% (E24) 1Ω ≤ R ≤ 10MΩ 0.5%, 1% (E24/E96) 1Ω ≤ R ≤ 10MΩ Jumper < 50mΩ	1Ω ≤ R < 10Ω ±200 ppm/°C 10Ω ≤ R ≤ 10MΩ ±100 ppm/°C 100Ω ≤ R ≤ 10MΩ ±50 ppm/°C	Rated Current 2A Max. Current 10A
	2 W		200V	500V	500V	5% (E24) 1Ω ≤ R ≤ 10MΩ 0.5%, 1% (E24/E96) 1Ω ≤ R ≤ 10MΩ	1Ω ≤ R < 10Ω ±200 ppm/°C 10Ω ≤ R ≤ 10MΩ ±100 ppm/°C	

FOOTPRINT AND SOLDERING PROFILES

For recommended footprint and soldering profiles of AF-series is the same as RC-series. Please see the special data sheet “Chip resistors mounting”.

PACKING STYLE AND PACKAGING QUANTITY

Table 3 Packing style and packaging quantity

PACKING STYLE	REEL DIMENSION	AF0100	AF0201	AF0402	AF0603	AF1210	AF1218
					AF0805		AF2010
					AF1206	AF2512	
Paper taping reel (R)	7" (178 mm)	20,000	10,000/20,000	10,000/20,000	5,000	5,000	--
	13" (330 mm)	--	50,000	50,000	20,000	20,000	--
Embossed taping reel (K)	7" (178 mm)	--	--	--	--	--	4,000

NOTE

I. For paper/embossed tape and reel specification/dimensions, please see the special data sheet “Chip resistors packing”.

FUNCTIONAL DESCRIPTION

OPERATING TEMPERATURE RANGE

AF0100 Range: -55°C to + 125°C

AF0201 - AF2512 Range: -55°C to + 155°C

POWER RATING

Each type rated power at 70°C:

AF0100=1/32W (0.03125W)

AF0201=1/20W (0.05W)

AF0402=1/16 W (0.0625W); 1/8W (0.125W)

AF0603=1/10 W (0.1W); 1/5W (0.2W)

AF0805=1/8 W (0.125W); 1/4W (0.25W)

AF1206=1/4 W (0.25W); 1/2W (0.5W)

AF1210=1/2W (0.5W); 1W

AF1218=1W; 1.5W

AF2010=3/4W (0.75W); 1.25W

AF2512=1W, 2W

RATED VOLTAGE

The DC or AC (rms) continuous working voltage corresponding to the rated power is determined by the following formula:

$$V = \sqrt{(P \times R)}$$

or max. working voltage whichever is less

Where

V = Continuous rated DC or AC (rms) working voltage (V)

P = Rated power (W)

R = Resistance value (Ω)



Fig. 9 Maximum dissipation (P_{max}) in percentage of rated power as a function of the operating ambient temperature (T_{amb})

TESTS AND REQUIREMENTS

Table 4 Test condition, procedure and requirements

TEST	TEST METHOD	PROCEDURE	REQUIREMENTS
High Temperature Exposure	AEC-Q200 Test 3 MIL-STD-202 Method 108	0100: 1,000 hours at 125 °C Others: 1,000 hours at 155± 3 °C unpowered	0100: ±(2.0%+0.05Ω) <50 mΩ for Jumper Others: ±(1.0%+0.05Ω) <100 mΩ for Jumper
Moisture Resistance	MIL-STD-202 Method 106	Each temperature / humidity cycle is defined at 8 hours, 3 cycles / 24 hours for 10d. with 25 °C / 65 °C 95% R.H, without steps 7a & 7b, unpowered	0100: ±(2.0%+0.05Ω) <50 mΩ for Jumper Others: ±(0.5%+0.05Ω) for 0.5%, 1% tol. ±(1.0%+0.05Ω) for 5% tol. <100 mΩ for Jumper
Biased Humidity	AEC-Q200 Test 7 MIL-STD-202 Method 103	1,000 hours; 85 °C / 85% RH 10% of operating power Measurement at 24±4 hours after test conclusion.	0100: ±(5%+0.05Ω) <50 mΩ for Jumper Others: 1Ω ≤ R ≤ 1MΩ : ±(3%+0.05Ω) 1MΩ < R ≤ 10MΩ: ±(5%+0.05Ω) <100 mΩ for Jumper
Operational Life	AEC-Q200 Test 8 IEC 60115-1 4.25 MIL-STD-202 Method 108	1,000 hours at 70 °C for 01005, 125 °C for others, derated voltage applied for 1.5 hours on, 0.5 hour off, still-air required	±(3.0%+0.05Ω) <100 mΩ for Jumper
Resistance to Soldering Heat	AEC-Q200 Test 15 MIL-STD-202 Method 210	Condition B, no pre-heat of samples Lead-free solder; 260±5 °C, 10±1 seconds immersion time Procedure 2 for SMD: devices fluxed and cleaned with isopropanol	0100: ±(1.0%+0.05Ω) Others: ±(0.5%+0.05Ω) for 0.5%, 1% tol. ±(1.0%+0.05Ω) for 5% tol. <50 mΩ for Jumper No visible damage
Thermal Shock	MIL-STD-202 Method 107	-55/+125 °C Number of cycles is 300. Devices mounted Maximum transfer time is 20 seconds. Dwell time is 15 minutes. Air – Air	0100: ±(1.0%+0.05Ω) <50 mΩ for Jumper Others: ±(0.5%+0.05Ω) for 0.5%, 1% tol. ±(1%+0.05Ω) for 5% tol. <100 mΩ for Jumper
ESD	AEC-Q200 Test 17 AEC-Q200-002	Human Body Model, I _{pos.} + I _{neg.} discharges 0201: 500V 0402/0603: 1KV 0805 and above: 2KV	±(3.0%+0.05Ω) <50 mΩ for Jumper

TEST	TEST METHOD	PROCEDURE	REQUIREMENTS
Solderability - Wetting	AEC-Q200 Test I8 J-STD-002	Electrical Test not required Magnification 50X SMD conditions: (a) Method B, aging 4 hours at 155 °C dry heat, dipping at 235±3 °C for 5±0.5 seconds. (b) Method B, steam aging 8 hours, dipping at 215±3 °C for 5±0.5 seconds. (c) Method D, steam aging 8 hours, dipping at 260±3 °C for 30±0.5 seconds.	Well tinned (≥95% covered) No visible damage
Board Flex	AEC-Q200 Test 21 AEC-Q200-005	Chips mounted on a 100mm x 40mm glass epoxy resin PCB (FR4) Bending for 01005/0201/0402: 5 mm 0603/0805: 3 mm 1206 and above: 2 mm Holding time: minimum 60 seconds	±(1.0%+0.05Ω) <50 mΩ for Jumper
Temperature Coefficient of Resistance (T.C.R.)	MIL-STD-202 Method 304	At +25/-55 °C and +25/+125 °C Formula: $T.C.R = \frac{R_2 - R_1}{R_1(t_2 - t_1)} \times 10^6 \text{ (ppm/°C)}$ Where t ₁ =+25 °C or specified room temperature t ₂ =-55 °C or +125 °C test temperature R ₁ =resistance at reference temperature in ohms R ₂ =resistance at test temperature in ohms	Refer to table 2
Short Time Overload	IEC60115-1 8.1	2.5 times of rated voltage or maximum overload voltage whichever is less for 5 sec at room temperature	0100: ±(2.0%+0.05Ω) Others: ±(1.0%+0.05Ω) <50 mΩ for Jumper No visible damage
FOS	ASTM-B-809-95* * Modified	Sulfur 750 hours, 105 °C. unpowered	0100: ±(5.0%+0.05Ω) Others: ±(4.0%+0.05Ω) <100 mΩ for Jumper

REVISION HISTORY

REVISION	DATE	CHANGE NOTIFICATION	DESCRIPTION
Version 9	Jan. 03, 2023	-	- 10ohm TCR upgrade to 100ppm, for 0603~2512 normal power and 0402~2512 double power.
Version 8	Mar. 26, 2021	-	- Add TCR 50ppm and size 01005 extend
Version 7	Nov. 1, 2019	-	- Add in AF double power
Version 6	Sep. 05, 2019	-	- Updated dimensions
Version 5	Jun. 21, 2016	-	- Update test and requirement
Version 4	Dec. 24, 2015	-	- Update Dielectric Withstanding Voltage& Resistance value
Version 3	Apr. 01, 2015	-	- Modified test and requirements
Version 2	Nov. 20, 2014	-	- Tests and requirement update
Version 1	Sep. 27, 2013	-	- Size 0201/1210/1218/2010/2512 extend
Version 0	Jan 07, 2011	-	- First issue of this specification

LEGAL DISCLAIMER

YAGEO, its distributors and agents (collectively, "YAGEO"), hereby disclaims any and all liabilities for any errors, inaccuracies or incompleteness contained in any product related information, including but not limited to product specifications, datasheets, pictures and/or graphics. YAGEO may make changes, modifications and/or improvements to product related information at any time and without notice.

YAGEO makes no representation, warranty, and/or guarantee about the fitness of its products for any particular purpose or the continuing production of any of its products. To the maximum extent permitted by law, YAGEO disclaims (i) any and all liability arising out of the application or use of any YAGEO product, (ii) any and all liability, including without limitation special, consequential or incidental damages, and (iii) any and all implied warranties, including warranties of fitness for a particular purpose, non -infringement and merchantability.

YAGEO products are designed for general purpose applications under normal operation and usage conditions. Please contact YAGEO for the applications listed below which require especially high reliability for the prevention of defects which might directly cause damage to the third party's life, body or property: Aerospace equipment (artificial satellite, rocket, etc.), Atomic energy-related equipment, Aviation equipment, Disaster prevention equipment, crime prevention equipment, Electric heating apparatus, burning equipment, Highly public information network equipment, data-processing equipment , Medical devices, Military equipment, Power generation control equipment, Safety equipment, Traffic signal equipment, Transportation equipment and Undersea equipment, or for any other application or use in which the failure of YAGEO products could result in personal injury or death, or serious property damage. Particularly **YAGEO Corporation and its affiliates do not recommend the use of commercial, automotive, and/or COTS grade products for high reliability applications or manned space flight.**

Information provided here is intended to indicate product specifications only. YAGEO reserves all the rights for revising this content without further notification, as long as products are unchanged. Any product change will be announced by PCN.

X-ON Electronics

Largest Supplier of Electrical and Electronic Components

Click to view similar products for [Thick Film Resistors - SMD category](#):

Click to view products by [Yageo manufacturer](#):

Other Similar products are found below :

[CR-05FL7--150R](#) [CR-05FL7--698K](#) [CR-12JP4--680R](#) [CRCW04021K20FKEE](#) [CRCW04028R20JNEE](#) [CRCW06032K10FKEC](#)
[CRCW06036K80FKEE](#) [M55342K03B499DRS6](#) [M55342K06B6E19RWL](#) [M55342K09B5D62RS6](#) [M55342M06B26E7RS3](#) [742C083750JTR](#)
[MCR01MRTF1001](#) [MCR01MZPF1202](#) [MCR01MZPF1601](#) [MCR01MZPF1800](#) [MCR01MZPF6201](#) [MCR01MZPF9102](#) [MCR01MZPJ121](#)
[MCR01MZPJ125](#) [MCR01MZPJ751](#) [MCR03EZPJ103](#) [MCR03EZPF2004](#) [MCR03EZPJ270](#) [MCR03EZPJ821](#) [MCR10EZPF1102](#)
[MCR18EZPJ330](#) [RC1005F1152CS](#) [RC1005F1372CS](#) [RC1005F2052CS](#) [RC1005F471CS](#) [RC1005F4751CS](#) [RC1005F5621CS](#)
[RC1005F6041CS](#) [RC1005J121CS](#) [RC1005J122CS](#) [RC1005J180CS](#) [RC1005J181CS](#) [RC1005J202CS](#) [RC1005J391CS](#) [RC1005J512CS](#)
[RC1005J683CS](#) [RC1005J823CS](#) [RC1608F333CS](#) [RC1608F5110CS](#) [RC1608J121CS](#) [RC2012F2493CS](#) [RC2012F2740CS](#) [RC2012J105CS](#)
[RC2012J470CS](#)