

# DATA SHEET

## ANTI-SULFURATED ARRAY CHIP RESISTORS AUTOMOTIVE GRADE

AF122 (4Pin/2R) / AF124 (8Pin/4R) /  
AF162 (4Pin/ 2R)/ AF164 (8Pin/ 4R)

5%, 1%

sizes 2 × 0402, 4 × 0402, 2 × 0603, 4 × 0603

RoHS compliant



**SCOPE**

This specification describes AF122/AF124/AF162/AF164 (convex) series chip resistor arrays with lead-free terminations made by thick film process.

**APPLICATIONS**

- Terminal for SDRAM and DDRAM
- High-end Computer & Multimedia Electronics in high sulfur environment
- Consume electronic equipments: PDAs, PNDs
- Mobile phone, telecom...

**FEATURES**

- AEC-Q200 qualified
- RoHS compliant
- Reducing environmentally hazardous wastes
- High component and equipment reliability
- Saving of PCB space
- None forbidden-materials used in products/production
- Halogen Free Epoxy
- Moisture sensitivity level: MSL 1

**ORDERING INFORMATION - GLOBAL PART NUMBER & I2NC**

Both part numbers are identified by the series, size, tolerance, packing type, temperature coefficient, taping reel and resistance value.

**YAGEO BRAND ordering code**

**GLOBAL PART NUMBER (PREFERRED)**

**AF XX X - X X X XX XXXX L**

(1) (2) (3) (4) (5) (6) (7)

**(1) SIZE**

12 = 0402 × 2 (0404)

12 = 0402 × 4 (0408)

16 = 0603 × 2 (0606)

16 = 0603 × 4 (0612)

**(2) NUMBER OF RESISTORS**

2 = 2 resistors

4 = 4 resistors

**(3) TOLERANCE**

F = ±1%

J = ±5% (for Jumper ordering, use code of J)

**(4) PACKAGING TYPE**

R = Paper taping reel

**(5) TEMPERATURE COEFFICIENT OF RESISTANCE**

– = Base on spec

**(6) TAPING REEL**

07 = 7 inch dia. Reel

13 = 13 inch dia. Reel

**(7) RESISTANCE VALUE**

There are 2~4 digits indicated the resistor value. Letter R/K/M is decimal point, no need to mention the last zero after R/K/M, e.g.1K2, not 1K20.

Detailed resistance rules show in table of "Resistance rule of global part number".

**Resistance rule of global part number**

Resistance code rule	Example
OR	OR = Jumper
XRXX	1R = 1 Ω
(1 to 9.76 Ω)	1R5 = 1.5 Ω
	9R76 = 9.76 Ω
XXRX	10R = 10 Ω
(10 to 97.6 Ω)	97R6 = 97.6 Ω
XXXR	100R = 100 Ω
(100 to 976 Ω)	
XKXX	1K = 1,000 Ω
(1 to 9.76 KΩ)	9K76 = 9760 Ω
XM	1M = 1,000,000 Ω
(1 MΩ)	

**ORDERING EXAMPLE**

The ordering code of a AF122 convex chip resistor array, value 1,000Ω with ±5% tolerance, supplied in 7-inch tape reel is: AF122-JR-071KL.

**NOTE**

1. All our R-Chip products meet RoHS compliant. "LFP" of the internal 2D reel label mentions "Lead Free Process"
2. On customized label, "LFP" or specific symbol printed and the optional "L" at the end of GLOBAL PART NUMBER

**MARKING**

**AF122**

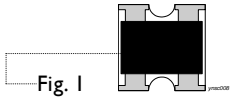

No marking

**AF124 / AF162 / AF164**

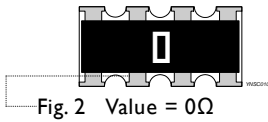

I-Digit marking

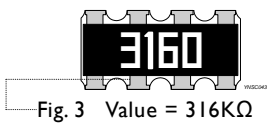

1% E-24/E-96:  $R \geq 100\Omega$  4digits  
First three digits for significant figure and 4th digit for number of zeros

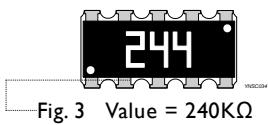

5% E-24:  $R \geq 10\Omega$   
First two digits for significant figure and 3rd digit for number of zeros

For further marking information, please refer to data sheet “Chip resistors marking”.

**CONSTRUCTION**

The resistor is constructed on top of a high-grade ceramic body. Internal metal electrodes are added on each end to make the contacts to the thick film resistive element. The composition of the resistive element is a noble metal embedded into a glass and covered by a glass. The resistor is laser trimmed to the rated resistance value. The resistor is covered with a protective epoxy coat, finally the external terminations (matte tin on Ni-barrier) are added as shown in Fig.4.

**OUTLINES**

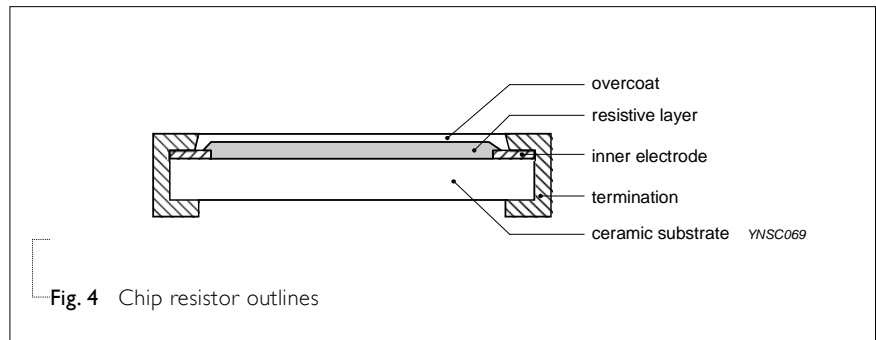

**DIMENSIONS**

Table I

TYPE	AF122	AF124	AF162	AF164
B (mm)	0.24±0.10	0.25±0.15	0.35±0.10	0.35±0.15
H (mm)	0.30+0.10/-0.05	0.45±0.05	0.30±0.10	0.65±0.05
H <sub>1</sub> (mm)	---	0.30±0.05	--	0.50±0.15
P (mm)	0.67±0.05	0.50±0.05	0.80±0.05	0.80±0.05
L (mm)	1.00±0.10	2.00±0.10	1.60±0.10	3.20±0.15
T (mm)	0.30±0.10	0.45±0.10	0.40±0.10	0.60±0.10
W <sub>1</sub> (mm)	0.25±0.10	0.30±0.15	0.30±0.10	0.30±0.15
W <sub>2</sub> (mm)	1.00±0.10	1.00±0.10	1.60±0.10	1.60±0.15

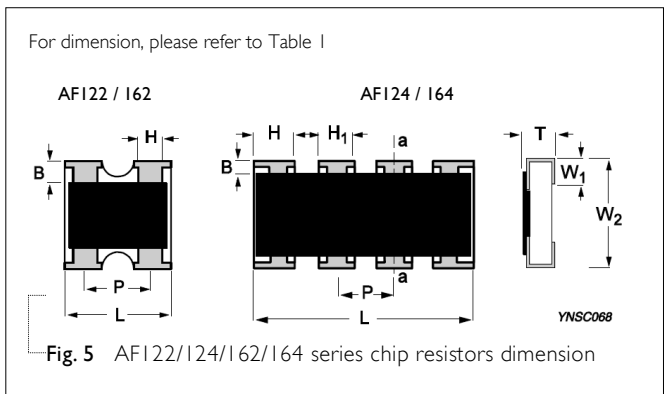

**SCHEMATIC**

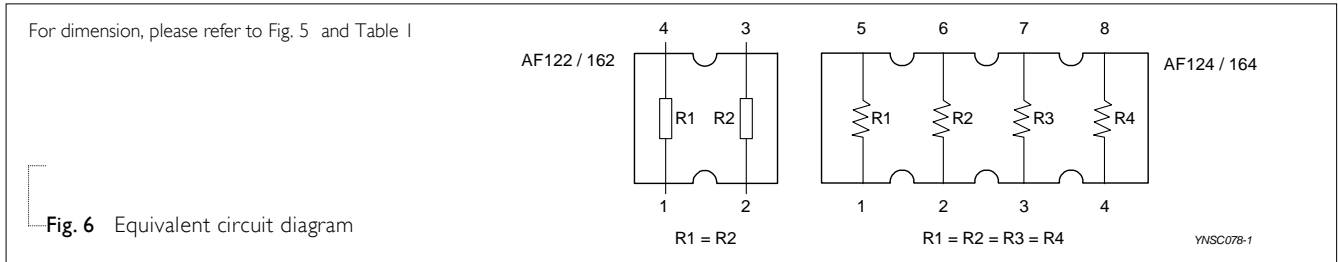

**ELECTRICAL CHARACTERISTICS**

**Table 2**

CHARACTERISTICS	AF122	AF124	AF162	AF164
Operating Temperature	-55 °C to +155 °C	-55 °C to +155 °C	-55 °C to +155 °C	-55 °C to +155 °C
Rated Power	1/16 W	1/16 W	1/16W	1/16W
Maximum Working Voltage	50 V	50 V	50V	50V
Maximum Overload Voltage	100 V	100 V	100V	100V
Dielectric Withstanding	100 V	100 V	100V	100V
Resistance Range	5% (E24) 1 Ω to 1 MΩ 1% (E24/E96) 10 Ω to 1 MΩ Jumper < 50 mΩ	5% (E24) 1 Ω to 1 MΩ 1% (E24/E96) 1 Ω to 1 MΩ Jumper < 50 mΩ	5% (E24) 1 Ω to 1 MΩ 1% (E24/E96) 1 Ω to 1 MΩ Jumper < 50 mΩ	5% (E24) 1 Ω to 1 MΩ 1% (E24/E96) 1 Ω to 1 MΩ Jumper < 50 mΩ
Temperature Coefficient	1 Ω ≤ R ≤ 10 Ω ±250 ppm/°C 10 Ω < R ≤ 1 MΩ ±200 ppm/°C			
Jumper Criteria	Rated Current 0.5 A Maximum Current 1.0 A	Rated Current 1.0 A Maximum Current 2.0 A	Rated Current 1.0 A Maximum Current 2.0 A	Rated Current 1.0A Maximum Current 2.0A

**FOOTPRINT AND SOLDERING PROFILES**

For recommended footprint and soldering profiles, please refer to data sheet “Chip resistors mounting”.

**PACKING STYLE AND PACKAGING QUANTITY**

**Table 3** Packing style and packaging quantity

PACKING STYLE	REEL DIMENSION	AF122	AF124	AF162	AF164
Paper Taping Reel (R)	7" (178 mm)	10,000 units	10,000 units	5,000 units	5,000 units
	13" (330 mm)	50,000 units	40,000 units	---	20,000 units

**NOTE**

I. For paper tape and reel specification/dimensions, please refer to data sheet “Chip resistors packing”.

**FUNCTIONAL DESCRIPTION**

**POWER RATING**

AF122 / AF124 / AF162 / AF164 rated power at 70 °C is 1/16 W

**RATED VOLTAGE**

The DC or AC (rms) continuous working voltage corresponding to the rated power is determined by the following formula:

$$V = \sqrt{(P \times R)}$$

or max. working voltage whichever is less

Where

V=Continuous rated DC or AC (rms) working voltage (V)

P=Rated power (W)

R=Resistance value ( $\Omega$ )

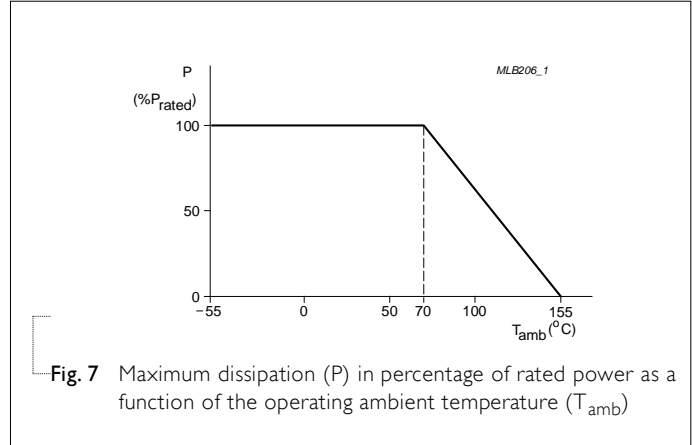

Fig. 7 Maximum dissipation (P) in percentage of rated power as a function of the operating ambient temperature (T<sub>amb</sub>)

**TESTS AND REQUIREMENTS**

Table 4 Test condition, procedure and requirements

TEST	TEST METHOD	PROCEDURE	REQUIREMENTS
High Temperature Exposure	AEC-Q200 Test 3 MIL-STD-202 Method 108	1,000 hours at T <sub>A</sub> = 155 °C, unpowered	±(2.0%+0.05Ω) <50 mΩ for Jumper
Moisture Resistance	AEC-Q200 Test 6 MIL-STD-202 Method 106	Each temperature / humidity cycle is defined at 8 hours (method 106F), 3 cycles / 24 hours for 10d. with 25 °C / 65 °C 95% R.H, without steps 7a & 7b, unpowered	±(2.0%+0.05Ω) <100 mΩ for Jumper
Biased Humidity	AEC-Q200 Test 7 MIL-STD-202 Method 103	1,000 hours; 85 °C / 85% RH 10% of operating power Measurement at 24±4 hours after test conclusion	±(3.0%+0.05Ω) <100 mΩ for Jumper
Operational Life	AEC-Q200 Test 8 MIL-STD-202 Method 108	1,000 hours at 125 °C, derated voltage applied for 1.5 hours on, 0.5 hour off, still-air required	±(3.0%+0.05Ω) <100 mΩ for Jumper
Resistance to Soldering Heat	AEC-Q200 Test 15 MIL-STD-202 Method 210	Condition B, no pre-heat of samples Lead-free solder, 260±5 °C, 10±1 seconds immersion time Procedure 2 for SMD: devices fluxed and cleaned with isopropanol	±(1.0%+0.05Ω) <50 mΩ for Jumper No visible damage
Thermal Shock	AEC-Q200 Test 16 MIL-STD-202 Method 107	-55/+125 °C Number of cycles is 300. Devices mounted Maximum transfer time is 20 seconds. Dwell time is 15 minutes. Air – Air	±(1.0%+0.05Ω) <50 mΩ for Jumper
ESD	AEC-Q200 Test 17 AEC-Q200-002	Human Body Model, 1 pos. + 1 neg. discharges I22/124: 500V I62/164: 1KV	±(3.0%+0.05 Ω) <50 mΩ for Jumper

TEST	TEST METHOD	PROCEDURE	REQUIREMENTS
Solderability - Wetting	AEC-Q200 Test I8 J-STD-002	Electrical Test not required Magnification 50X SMD conditions: (a) Method B, aging 4 hours at 155 °C dry heat, dipping at 235±3 °C for 5±0.5 seconds. (b) Method B, steam aging 8 hours, dipping at 215±3 °C for 5±0.5 seconds. (c) Method D, steam aging 8 hours, dipping at 260±3 °C for 30±0.5 seconds.	Well tinned (≥95% covered) No visible damage
Board Flex	AEC-Q200 Test 21 AEC-Q200-005	Chips mounted on a 90mm glass epoxy resin PCB (FR4) 3mm Holding time: minimum 60 seconds	±(1.0%+0.05Ω) <50 mΩ for Jumper
Temperature Coefficient of Resistance (T.C.R.)	MIL-STD-202 Method 304	At +25/-55 °C and +25/+125 °C  <b>Formula:</b> $T.C.R = \frac{R_2 - R_1}{R_1(t_2 - t_1)} \times 10^6 \text{ (ppm/°C)}$ Where t <sub>1</sub> = +25 °C or specified room temperature t <sub>2</sub> = -55 °C or +125 °C test temperature R <sub>1</sub> = resistance at reference temperature in ohms R <sub>2</sub> = resistance at test temperature in ohms	Refer to table 2
Short Time Overload	IEC60115-1 4.13	2.5 times of rated voltage or maximum overload voltage whichever is less for 5 sec at room temperature	±(2.0%+0.05Ω) <50 mΩ for Jumper
FOS	ASTM-B-809-95* *Modified	Sulfur 750 hours, 105°C, unpowered	±(4.0%+0.05Ω) <100mΩ for Jumper

REVISION HISTORY

REVISION	DATE	CHANGE NOTIFICATION	DESCRIPTION
Version 6	Apr. 21, 2021	-	- Upgrade to Automotive Grade and voltage of AF124 updated, TCR of AF164 updated.
Version 5	Mar. 20, 2017	-	- Modify AF124/164 Equivalent Circuit Diagram
Version 4	Jun. 23, 2016	-	- AEC-Q200 qualified
Version 3	Nov. 17, 2015	-	- Add in AF162
Version 2	May 29, 2015	-	- Add in AF164
Version 1	Aug. 15, 2014	-	- Update AF124 dimensions
Version 0	Oct. 02, 2013	-	- First issue of this specification

*“ Yageo reserves all the rights for revising the content of this datasheet without further notification, as long as the products itself are unchanged. Any product change will be announced by PCN.”*



LEGAL DISCLAIMER

YAGEO, its distributors and agents (collectively, "YAGEO"), hereby disclaims any and all liabilities for any errors, inaccuracies or incompleteness contained in any product related information, including but not limited to product specifications, datasheets, pictures and/or graphics. YAGEO may make changes, modifications and/or improvements to product related information at any time and without notice.

YAGEO makes no representation, warranty, and/or guarantee about the fitness of its products for any particular purpose or the continuing production of any of its products. To the maximum extent permitted by law, YAGEO disclaims (i) any and all liability arising out of the application or use of any YAGEO product, (ii) any and all liability, including without limitation special, consequential or incidental damages, and (iii) any and all implied warranties, including warranties of fitness for a particular purpose, non-infringement and merchantability.

YAGEO products are designed for general purpose applications under normal operation and usage conditions. Please contact YAGEO for the applications listed below which require especially high reliability for the prevention of defects which might directly cause damage to the third party's life, body or property: Aerospace equipment (artificial satellite, rocket, etc.), Atomic energy-related equipment, Aviation equipment, Disaster prevention equipment, crime prevention equipment, Electric heating apparatus, burning equipment, Highly public information network equipment, data-processing equipment, Medical devices, Military equipment, Power generation control equipment, Safety equipment, Traffic signal equipment, Transportation equipment and Undersea equipment, or for any other application or use in which the failure of YAGEO products could result in personal injury or death, or serious property damage. Particularly **YAGEO Corporation and its affiliates do not recommend the use of commercial or automotive grade products for high reliability applications or manned space flight.**

Information provided here is intended to indicate product specifications only. YAGEO reserves all the rights for revising this content without further notification, as long as products are unchanged. Any product change will be announced by PCN.

## X-ON Electronics

Largest Supplier of Electrical and Electronic Components

*Click to view similar products for [Resistor Networks & Arrays](#) category:*

*Click to view products by [Yageo](#) manufacturer:*

Other Similar products are found below :

[CSC06A0122K0GEJ](#) [CSC08A01470KGEK](#) [M8340105K1002FGD03](#) [M8340105M4700JGD03](#) [M8340107K1471FGD03](#)  
[M8340108K2402GGD03](#) [M8340108K3240FGD03](#) [M8340108K3242FGD03](#) [M8340108K3743FGD03](#) [M8340108K4991FGD03](#)  
[M8340108K6192FGD03](#) [M8340109K2002FCD03](#) [M8340109K2872FCD03](#) [M8340109K4700GGD03](#) [M8340109M4701GCD03](#)  
[M8340109MA010GHD03](#) [744C083101JTR](#) [EXB-U18240JX](#) [744C083270JTR](#) [745C102472JP](#) [745X101103JP](#) [MDP1603100KGE04](#)  
[770101223](#) [MNR04M0APJ471](#) [MNR14E0APJ100](#) [MNR18E0APJ102](#) [MNR18E0APJ680](#) [ACAS06S0830339P100](#) [ACAS06S0830343P100](#)  
[ACAS06S0830344P100](#) [RAVF164DJT68K0](#) [RM2012A-102/104-PBVW10](#) [RM2012A-502104-PBVW10](#) [NRSN04I4J220TRF](#)  
[NRSN06I4J330TRF](#) [NRSNA4I4J330TRF](#) [8B472TR4](#) [ACAS06S0830341P100](#) [ACAS06S0830342P100](#) [ACAS06S0830345P100](#) [EXB-](#)  
[18N390JX](#) [CSC09A014K70JEK](#) [M8340105K1502GGD03](#) [M8340105K8251FGD03](#) [M8340107K3402FCD03](#) [M8340108K1000GGD03](#)  
[M8340108K2001FCD03](#) [M8340108K3901GGD03](#) [M8340108K5111FGD03](#) [M8340108K6201GGD03](#)