

Approval Sheet

for

**Carbon Film Resistors
General Type**

CFR series

$\pm 2\%$ & $\pm 5\%$

YAGEO CORPORATION

Headquarters: 3F, No.233-1, Pao Chiao Rd., Xindian, Taipei, Taiwan, R.O.C.

Tel: 886-2-6629-9999 **Fax:** 886-2-6628-8885

URL: www.yageo.com

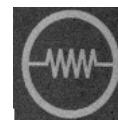

Rev.	Description	Issue Date	Drawn	Approved
00	issue new spec.	Jul 16, 2007	Sara Lin	Joyce Chung
01	Add new lead dia for 52.4mm	Nov 8, 2007	Lynn Chen	Joyce Chung
02	New lead dia is included(F:φd≥0.6mm)	Jan 31, 2008	Lynn Chen	Joyce Chung
03	Add special forming type(52H)	Apr 22, 2009	Lynn Chen	Ken Hsu
04	The environmental characteristics are adjusted.	Jan 11, 2011	Feng Ye	Ken Hsu
05	“MB”, “MR” forming types are included	Jul 14, 2011	Feng Ye	Ken Hsu
06	“62-” special type is included	Dec 05, 2011	Feng Ye	Ken Hsu
07	Revise the applicable range of PN & AV types forming for taping.	Mar 07, 2012	Feng Ye	Ken Hsu
08	26A &26C types are included	Mar 29, 2012	Feng Ye	Ken Hsu
09	Revise S.T.O test description	Mar 31, 2012	Feng Ye	Ken Hsu
10	Dimension h of FK&FFK&FKK types is revised; “62-” special type is deleted;	May 31, 2013	Feng Ye	Flora Shen
11	Add “H” dimension for Short lead type for CFR200&CFR3WS types	Jun.24, 2014	Feng Ye	Flora Shen
12	Revise forming pitch value from 6±1 to 8±1 for CFR200&CFR3WS types	Sep.22, 2014	Feng Ye	Flora Shen
13	Revised the dia. of 52T type. Deleted the MR type.	Sep.23, 2015	Feng Ye	Flora Shen
14	T-63 type is included	Aug.30, 2016	Feng Ye	Flora Shen
15	Deleted 52T type.	Jun.12, 2018	Mingfa Liu	Feng Ye
16	Revised the dimension “A” of tape on reel packing , Add dimension “B” for tape on reel packing.	Feb.25, 2020	Mingfa Liu	Feng Ye

Description	Carbon Film Resistors, General Type		
Series	CFR	Rev.	16

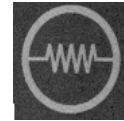

1. PRODUCT:

CARBON FILM RESISTORS-GENERAL TYPE
(Normal & Miniature Style)

2. PART NUMBER:

Part number of the carbon film resistor is identified by the name, power, tolerance, packing, temperature coefficient, special type and resistance value. The resistors are coated with layers of tan color lacquer.
Example:

CFR	-12	J	T	-	52H	100R
(1)	(2)	(3)	(4)	(5)	(6)	(7)
Series Name	Power Rating	Resistance Tolerance	Packing Style	Temperature Coefficient of Resistance	Special Type	Resistance Value

(1) Style: CFR SERIES

(2) Power Rating: -12=1/6W、25S=1/4W、-25=1/4W、50S=1/2W、-50=1/2W、1WS=1W、100=1W、2WS=2W、200=2W、3WS=3W

(3) Tolerance: G=±2% J=±5%

(4) Packaging Type: R = Paper Taping Reel
T = Tape on Box Packing
B = Bulk Packing

(5) Temperature Coefficient: “-“=Base on spec., see p.4 Table 1

(6) Special Type: 26- = 26mm, 52- = 52.4mm, 73- = 73mm
26A = 26mm with 0.4±0.02mm Φd
26C = 26mm with 0.5±0.02mm Φd
26G = 26mm with Φd ≥ 0.6mm
52A = 52.4mm with 0.4±0.02mm Φd
52B = 52.4mm with 0.45±0.02mm Φd
52C = 52.4mm with 0.5±0.02mm Φd
52G = 52.4mm with Φd ≥ 0.6mm
52H = 52.4mm without lacquer on soldering spots
63F = 63mm with 0.55±0.05mm Φd
73G = 73mm with Φd ≥ 0.6mm
M = M Type Forming for Bulk
MB=MB-Type Forming
F = F Type Forming for Bulk
FK = FK Type Forming
FFK = FFK Type Forming
FKK = FKK Type Forming
MT = MTsert (rated watts -12 & 25s size only)
PN = PANAsert (rated watts from 1/4W to 2WS applicable only)
AV = Avlsert (rated watts from 1/4W to 2WS applicable only)

(7) Resistance Value: E24 Series
Example: 1R、10R、100R、10K、100K、330K、1M.....

3. BAND-CODE:

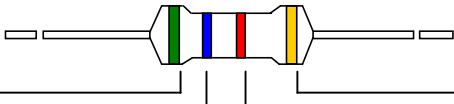

COLOR	1ST BAND	2ND BAND	MULTIPLIER	TOLERANCE
BLACK	0	0	1Ω	
BROWN	1	1	10Ω	
RED	2	2	100Ω	± 2% (G)
ORANGE	3	3	1KΩ	
YELLOW	4	4	10KΩ	
GREEN	5	5	100KΩ	
BLUE	6	6	1MΩ	
VIOLET	7	7	10MΩ	
GREY	8	8		
WHITE	9	9		
GOLD			0.1Ω	± 5% (J)
SILVER			0.01Ω	

4. ELECTRICAL CHARACTERISTICS

TABLE 1

STYLE	CFR-12	CFR25S	CFR-25	CFR50S	CFR-50	CFR1WS	CFR100	CFR2WS	CFR200	CFR3WS
Power Rating at 70 °C	1/6W	1/4W		1/2W		1W		2W		3W
Maximum Working Voltage	150V	200V	250V	300V	350V	400V	500V			
Maximum Overload Voltage	300V	400V	500V	600V	700V	800V	1000V			
Voltage Proof	300V	400V	500V			700V	1000V			
Resistance Range	1Ω ~ 10MΩ & 0Ω for E24 series value									
Operating Temp. Range	- 55 °C to + 155 °C									
Temperature Coefficient	see Table. 2									

* Below or over this resistance on request.

TABLE.2 TEMPERATURE COEFFICIENT

STYLE	Max. Value of Temp. Coefficient ppm/°C		
	Under 100KΩ	100K ~ 1MΩ	1M ~ 10MΩ
CFR100, CFR200, CFR2WS CFR3WS	± 350	-500~0	-1500~0
CFR-12 , CFR-25 , CFR-50 CFR25S , CFR50S , CFR1WS	+ 350 ~ - 500	-700~0	-1500~0

5. DERATING CURVE

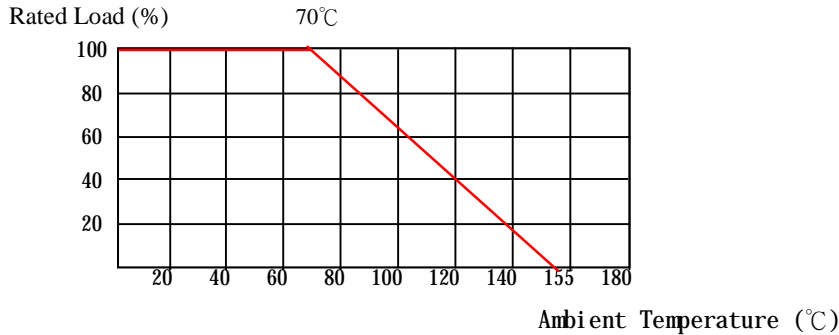

6. DIMENSIONS

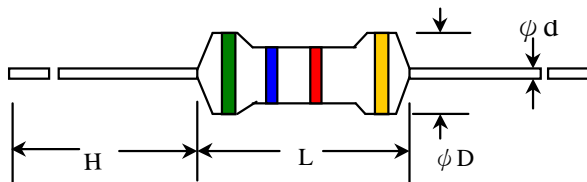

STYLE		DIMENSION			
Normal	Miniature	L	ϕD	H	ϕd
CFR-12	CFR25S	3.4±0.3	1.9±0.2	28±2.0	0.45±0.05
CFR-25	CFR50S	6.3±0.5	2.4±0.2	28±2.0	0.55±0.05
CFR-50	CFR1WS	9.0±0.5	3.3±0.3	26±2.0(T-52 type) 32±2.0(T-63F type)	0.55±0.05
CFR100	CFR2WS	11.5±1.0	4.5±0.5	35±2.0 (T-73 type) 25±2.0 (T-52 type)	0.8±0.05
CFR200	CFR3WS	15.5±1.0	5.0±0.5	33±2.0	0.8±0.05

7. ENVIRONMENTAL CHARACTERISTICS

(1) Short Time Over Load Test

At 2.5 times of the rated voltage or max. overload voltage for 5 seconds, whichever is less; the resistor should be free from defects after the resistor is released from load for about 30 minutes

$$\text{Rated Voltage} = \sqrt{\text{Power Rating} \times \text{Resistance Value}}$$

The change of the resistance value should be within $\pm 0.75\% + 0.05\Omega$

(2) Voltage Proof

The resistor shall be clamped in the trough of a 90° metal V Block. Apply the insulation voltage specified in the "Table I" between the terminals connected together with the block for about 60 seconds. The resistor shall be able to withstand without breakdown or flashover.



(3) Temperature Coefficient Test

Test of resistors above room temperature $100^{\circ}\text{C} \pm 2^{\circ}\text{C}$ (Testing Temperature 115°C to 130°C) at the constant temperature silicon plate for over 5 minutes. Then measure the resistance value. The Temperature Coefficient is calculated by the following equation and its value should be within the range of requested.

$$\text{Resistor Temperature Coefficient} = \frac{R - R_0}{R_0} \cdot \frac{1}{t - t_0} \cdot 10^6$$

R = Resistance value under the testing temperature

R₀ = Resistance value at the room temperature

t = The testing temperature

t₀ = Room temperature

(4) Insulation Resistance

Apply "measuring voltage" between protective coating and termination for 1 min., then measure. The measuring voltage shall be either $100\text{V} \pm 15\text{V}$ d.c. for resistors with an insulation voltage lower than 500V or $500\text{V} \pm 50\text{V}$ d.c. for resistors with an insulation voltage equal to or greater than 500V .

The test resistance should be high than $1,000\text{M ohm}$.

(5) Solderability

Immerse the specimen into the solder pot at $245 \pm 5^{\circ}\text{C}$ for 3 ± 0.5 seconds.

At least 95% solder coverage on the termination.

(6) Solvent Resistance of Marking

The specimen into the appropriate solvent of IPA condition of ultrasonic machine for 5 ± 0.5 minutes.

The specimen is no deterioration of coatings and color code.

(7) Robustness of Terminations

Direct Load – Resistors shall be held by one terminal and the load shall be gradually applied in the direction of the longitudinal axis of the resistor unit the applied load reached the requirement.

The load shall be held for 10 seconds. The load of weight shall be $\geq 2.5 \text{ kg}$ (24.5N).

(8) Damp Heat Steady State

Place the specimen in a test chamber at $40 \pm 2^{\circ}\text{C}$ and 90 ~ 95 % relative humidity. Apply the 0.1 times rated voltage to the specimen at the 1.5 hours on and 0.5 hour off cycle. The total length of test is 56 days.

The change of the resistance value shall be within $\pm 3.0 \% + 0.05 \Omega$

(9) Endurance at 70°C

Placed in the constant temperature chamber of $70 \pm 3^{\circ}\text{C}$ the resistor shall be connected to the lead wire at the point of 25mm. Length with each terminal, the resistors shall be arranged not much effected mutually by the temperature of the resistors and the excessive ventilation shall not be performed, for 90 minutes on and 30 minutes off under this condition the rated D.C. voltage is applied continuously for $1000+48/-0$ hours then left at no-load for 1hour, measured at this time the resistance value.

The change of the resistance value shall be within $\pm 3.0 \% + 0.05 \Omega$.

There shall be no remarkable change in the appearance and the color code shall be legible after the test.

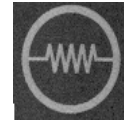

(10) Temperature Cycling Test

The temperature cycle shown in the following table shall be repeated 5 times consecutively. The measurement of the resistance value is done before the first cycle and after ending the fifth cycle, leaving in the room temperature for about 1 hour.

Temperature Cycling Conditions:

Step	Temperature(°C)	Time (minute)
1	-40 ± 3	30
2	25 ± 3	10 ~ 15
3	155 ± 3	30
4	25 ± 3	10 ~ 15

The change of the resistance value shall be within ± 1.0 % + 0.05 Ω
After the test the resistor shall be free from the electrical or mechanical damage.

(11) Resistance to Soldering Heat

The terminal lead shall be dipped into the solder pot at 260 ± 3 °C for 10 ± 1.0 seconds up to 2.5 ~ 3.5 mm.

The change of the resistance value shall be within ± 1.0 % + 0.05 Ω

(12) Pulse Overload

Apply 4 times of rated voltage to the specimen at the 1 second on and 25 seconds off cycle, subjected to voltage application cycles specified in 10,000 time.

The change of the resistance value shall be within ± 1.0% + 0.05 Ω

8. PACKING METHODS

Bandolier for Axial leads

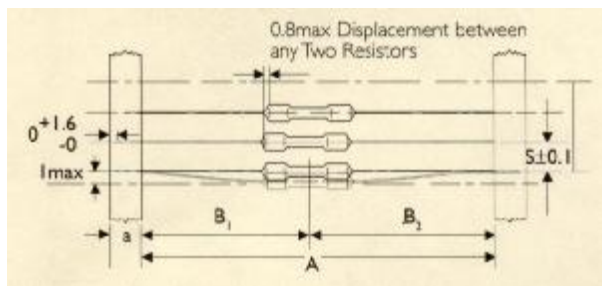

STYLE		DIMENSIONS				Unit: : mm					
Normal	Miniature	a	A	B1-B2	S (spacing)	T (max. deviation of spacing)					
CFR-12	CFR25S	6 ± 0.5	52.4 ± 1.0	1.2	5	1 mm per 10 spacing 0.5 mm per 5 spacing					
			26.0 ± 1.0	1.0							
CFR-25	CFR50S	6 ± 0.5	52.4 ± 1.0	1.2	5			1 mm per 10 spacing 0.5 mm per 5 spacing			
			26.0 ± 1.0	1.0							
CFR-50	CFR1WS	6 ± 0.5	52.4 ± 1.0	1.2	5					1 mm per 10 spacing 0.5 mm per 5 spacing	
			63.0 ± 1.0	1.5							
CFR100	CFR2WS	6 ± 0.5	73.0 ± 1.5	1.5	5	1 mm per 10 spacing 0.5 mm per 5 spacing					
			52.4 ± 1.0	1.2							
CFR200	CFR3WS	6 ± 0.5	73.0 ± 1.5	1.5	10			1 mm per 10 spacing 0.5 mm per 5 spacing			
			52.4 ± 1.0	1.2							

9. TAPE ON REEL PACKING

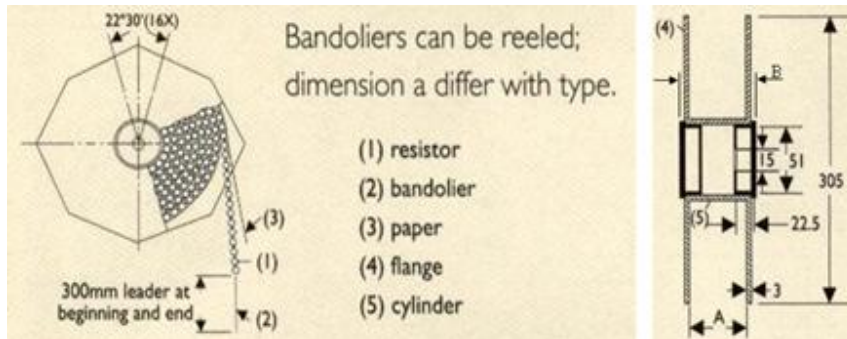

STYLE		TAPE ON REEL		
Normal	Miniature	ACROSS FLANGE (A)	B	Qty per reel
CFR-12	CFR25S	66.5	75.5	5,000
CFR-25	CFR50S	66.5	75.5	5,000
CFR-50	CFR1WS	66.5	75.5	2,500
CFR100	CFR2WS	87	96	2,000
CFR200	CFR3WS	87	96	1,000

10. TAPE ON BOX PACKING

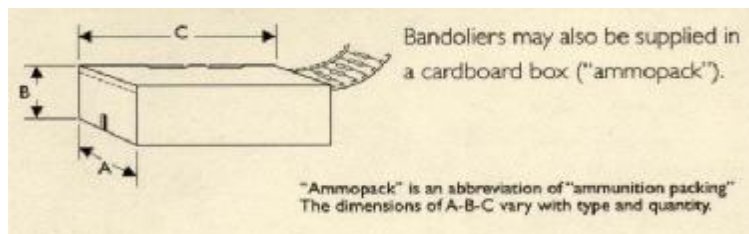

STYLE		Standard Lead Length			Short Lead Length			Qty per box
Normal	Miniature	W (A)	H (B)	L (C)	W (A)	H (B)	L (C)	
CFR-12	CFR25S	81	70	260	48	102	255	5,000
CFR-25	CFR50S	81	104	260	48	102	255	5,000
CFR-50	CFR1WS	73	45	258				1,000
CFR100	CFR2WS	103	78	260	81	91	260	1,000
CFR200	CFR3WS	103	94	260	81	91	260	1,000

11. SPECIAL TYPE (FORMING DIMENSIONS)

M TYPE

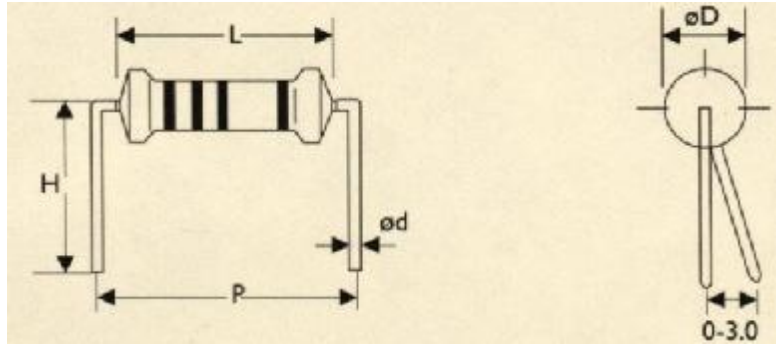

STYLE		DIMENSIONS					UNIT : mm
Normal	Miniature	L	ϕD	ϕd	P	H	
CFR-12	CFR25S	3.4 ± 0.3	1.9 ± 0.2	0.45 ± 0.05	6.0 ± 1.0	10.0 ± 1	
CFR-25	CFR50S	6.3 ± 0.5	2.4 ± 0.2	0.55 ± 0.05	10.0 ± 1	10.0 ± 1	
CFR-50	CFR1WS	9.0 ± 0.5	3.3 ± 0.3	0.55 ± 0.05	12.5 ± 1	10.0 ± 1	
CFR100	CFR2WS	11.5 ± 1.0	4.5 ± 0.5	0.8 ± 0.05	15.0 ± 1	12.5 ± 1	
CFR200	CFR3WS	15.5 ± 1.0	5.0 ± 0.5	0.8 ± 0.05	20.0 ± 1	15.0 ± 1	

MB TYPE

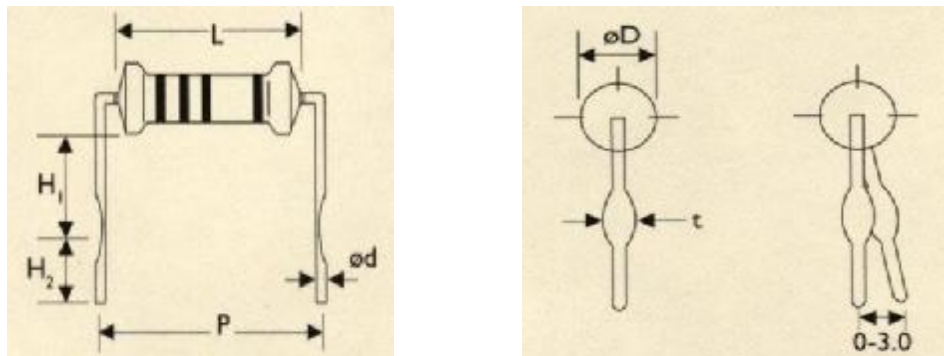

STYLE		DIMENSIONS							UNIT : mm
Normal	Miniature	L	ϕD	ϕd	P	H 1	H 2	t	
CFR-25	CFR50S	6.3 ± 0.5	2.4 ± 0.2	0.55 ± 0.05	10.0 ± 1	6.0 ± 1	5.0 ± 1	1.2 ± 0.2	
CFR-50	CFR1WS	9.0 ± 0.5	3.3 ± 0.3	0.55 ± 0.05	12.5 ± 1	6.0 ± 1	5.0 ± 1	1.2 ± 0.2	
CFR100	CFR2WS	11.5 ± 1.0	4.5 ± 0.5	0.8 ± 0.05	15.0 ± 1	6.0 ± 1	5.0 ± 1	1.4 ± 0.2	
CFR200	CFR3WS	15.5 ± 1.0	5.0 ± 0.5	0.8 ± 0.05	20.0 ± 1	10.0 ± 1	5.0 ± 1	1.4 ± 0.2	

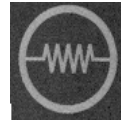

F TYPE

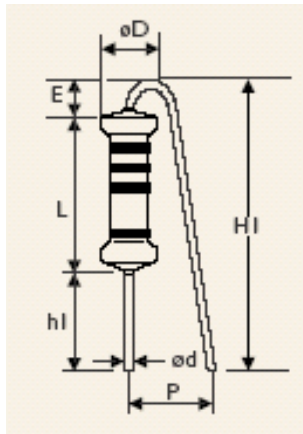

STYLE		DIMENSIONS						UNIT : mm	
Normal	Miniature	L	ϕD	ϕd	P	h1	H1 max	E max	
CFR100	CFR2WS	11.5 ± 1.0	4.5 ± 0.5	0.8 ± 0.05	6.0 ± 1	5.0 ± 1	20	3.5	
CFR200	CFR3WS	15.5 ± 1.0	5.0 ± 0.5	0.8 ± 0.05	8.0 ± 1	5.0 ± 1	25	3.5	

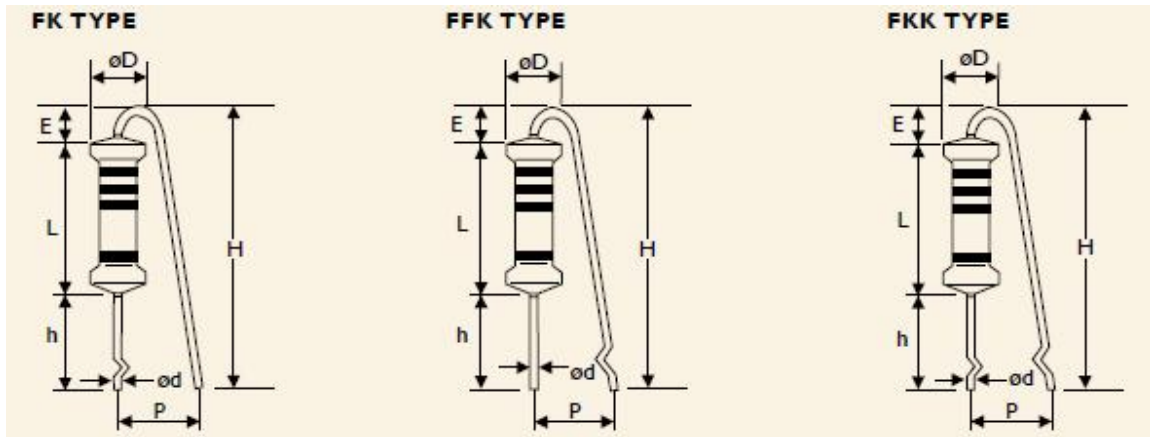

STYLE		DIMENSIONS						UNIT:mm	
Normal	Miniature	L	ϕD	ϕd	P	h	H max	E max	
CFR100	CFR2WS	11.5 ± 1.0	4.5 ± 0.5	0.8 ± 0.05	6.0 ± 1	8.0 ± 1	25	3.5	
CFR200	CFR3WS	15.5 ± 1.0	5.0 ± 0.5	0.8 ± 0.05	8.0 ± 1	8.0 ± 1	30	3.5	

MT Type Forming for Taping (Rated Watts -12 & 25S size only)

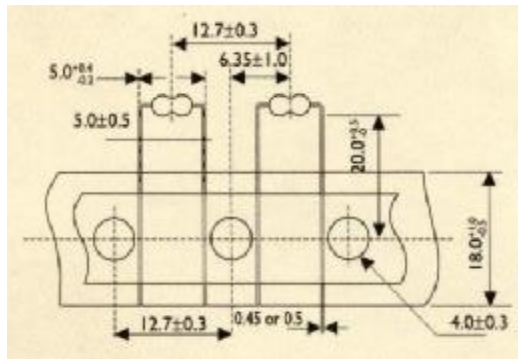

PN Type Forming for Taping (rated watts from 1/4W to 2WS applicable only)

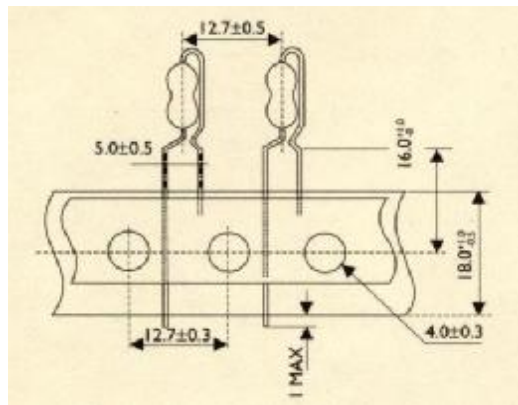

AV Type Forming for Taping (rated watts from 1/4W to 2WS applicable only)

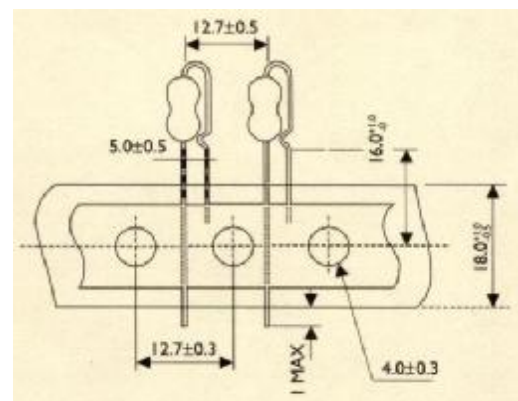

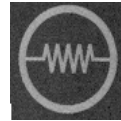

12. Plant Address

- A. China Dongguan Plant
7-1, Gaoli Road, Gaoli Industrial Zone
Tangxia Zhen, Dongguan, Guangdong, China
(廣東省東莞市塘廈鎮高麗工業區高麗路 7-1 號)
Tel. 86-769-8772 0275
Fax. 86-769-8772 0275 #4333

- B. China Suzhou Plant
No.158, Jinchang Road, No.1 Building of NanBangIND.Zone,
Mu Du New District, Suzhou, China
(江蘇省蘇州市木瀆新區金長路 158 號南濱工業區 1 號)
Tel. 86-512-66518889
Fax. 86-512-66519889

X-ON Electronics

Largest Supplier of Electrical and Electronic Components

Click to view similar products for [Carbon Film Resistors - Through Hole](#) category:

Click to view products by [Yageo](#) manufacturer:

Other Similar products are found below :

[RCFQ-100-5TA](#) [RCFQ-100K-5TA](#) [RCFQ-10-5TA](#) [RCFQ-11-5TA](#) [RCFQ-12-5TA](#) [RCFQ-150K-5TA](#) [RCFQ-15K-5TA](#) [RCFQ-160-5TA](#)
[RCFQ-160K-5TA](#) [RCFQ-180-5TA](#) [RCFQ-18-5TA](#) [RCFQ-18K-5TA](#) [RCFQ-220-5TA](#) [RCFQ-240K-5TA](#) [RCFQ-24-5TA](#) [RCFQ-270K-5TA](#)
[RCFQ-27-5TA](#) [RCFQ-330K-5TA](#) [RCFQ-33K-5TA](#) [RCFQ-360-5TA](#) [RCFQ-360K-5TA](#) [RCFQ-390K-5TA](#) [RCFQ-430K-5TA](#) [RCFQ-43-5TA](#)
[RCFQ-47-5TA](#) [RCFQ-62-5TA](#) [RCFQ-680-5TA](#) [RCFQ-750-5TA](#) [RCFQ-91-5TA](#) [RCFQ-91K-5TA](#) [150-04720](#) [OM1625](#) [OMT200L](#)
[ON2725E](#) [23ESA473MLA50N](#) [CF1/4-8.2M-5%](#) [CFB1/2C101J](#) [CFB1/2C102J](#) [CFR16J1K0](#) [CFR50J8K2](#) [CFS1/2C512J](#) [RCFQ-110-5TA](#)
[RCFQ-110K-5TA](#) [RCFQ-11K-5TA](#) [RCFQ-120K-5TA](#) [RCFQ-130-5TA](#) [RCFQ-13-5TA](#) [RCFQ-150-5TA](#) [RCFQ-15-5TA](#) [RCFQ-1-5TA](#)