

LEADED RESISTORS 2011





4	Metal Film Resistors	General Type	[MFR Series]
6	Metal Film Resistors	Precision Type	[MFP Series]
8	Metal Film Resistors	Professional Type	[MF0 Series]
10	Metal Film Resistors	Flame-Proof Type	[FMF Series]
12	Metal Film Resistors	Professional & Flame-Proof Type	[FM0 Series]
14	Metal Film Resistors	High Power Type	[FMP Series]
16	Metal Film Resistors	Fusible & Flame-Proof Type	[FRM Series]
18	Metal Film Resistors	Biased Humidity Type	[MFN Series]
20	Metal Film Resistors	HID Lamps Type	[HTM Series]
22	Metal Oxide Film Resistors	Flame-Proof Type	[RSF Series]
24	Metal Oxide Film Resistors	Low-Inductive & Flame-Proof Type	[LIR Series]
26	Melf Metal Film Resistors	General Type	[MMF Series]
28	Melf Metal Film Resistors	High Power Type	[MMP Series]
30	Carbon Film Resistors	General Type	[CFR Series]
32	Carbon Film Resistors	Professional Type	[CF0 Series]
34	Carbon Film Resistors	Flame-Proof Type	[FCR Series]
36	Carbon Film Resistors	Professional & Flame-Proof Type	[FC0 Series]
38	Carbon Film Resistors	Non-Inductive & Flame-Proof Type	[NCR Series]
40	Carbon Film Resistors	Biased Humidity Type	[CFN Series]
42	Melf Carbon Film Resistors	General Type	[MCF Series]
44	Melf Carbon Film Resistors	High Power Type	[MCP Series]
46	Metal Glazed Film Resistors	High Voltage & High Ohmic Type	[HHV Series]
48	Pulse-Loading Resistors	Anti-Pulse Type	[APR Series]
50	Zero Ohm Resistors	Coating Type	[ZOR Series]
51	Jumper Wires	Tinned-Copper Wire Type	[JPW Series]
52	Low Ohmic Wire Resistors	Alloy-Wire Type	[MCW Series]
54	Wirewound Resistors	Flame-Proof Type	[KNP Series]
56	Wirewound Resistors	Flame-Proof & Non-Inductive Type	[NKN Series]
58	Wirewound Resistors	Fusible & Flame-Proof Type	[FKN Series]
60	Wirewound Resistors	High Power Type	[PNP Series]
62	Wirewound Resistors	High Power Type	[PNPV Series]
64	Cement Resistors	Axial Lead Type	[SQP / NSP Series]
66	Cement Resistors	Vertical Lead Type	[SQM / NSM Series]
68	Cement Resistors	Radial Terminals Type	[SQZ / NSZ Series]
70	Cement Resistors	Power Wirewound & Axial Lead Type	[PSP Series]
72	Cement Resistors	Power Wirewound & Vertical Lead Type	[PSM Series]
74	Cement Resistors	Fusible Thermal & Vertical Lead Type	[FTR Series]
76	Cement Resistors	Low Ohmic Metal Plate Type	[SLR Series]
78	Aluminum Housed Resistors	Power Wirewound Type	[AHA / AHP Series]
80	General Information		

Metal Film Resistors

General Type

Normal & Miniature Style [MFR Series]

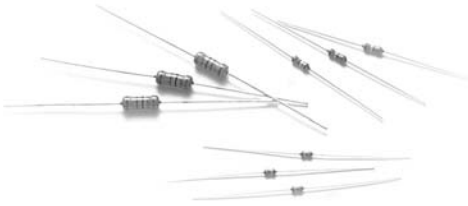

INTRODUCTION

The MFR Series Metal Film Resistors are manufactured using a vacuum sputtering system to deposit multiple layers of mixed metal alloys and passivative materials onto a carefully treated high grade ceramic substrate. After a helical groove has been cut in the resistive layer, tinned connecting leads of electrolytic copper are welded to the end-caps. The resistors are coated with layers of blue color lacquer.

FEATURES

Power Rating	1/6W, 1/4W, 1/2W, 1W, 2W, 3W
Resistance Tolerance	±0.5%, ±1%, ±5%
T.C.R.	±15ppm/°C, ±25ppm/°C, ±50ppm/°C, ±100ppm/°C

DERATING CURVE

For resistors operated in ambient temperatures above 70°C, power rating must be derated in accordance with the curve below.

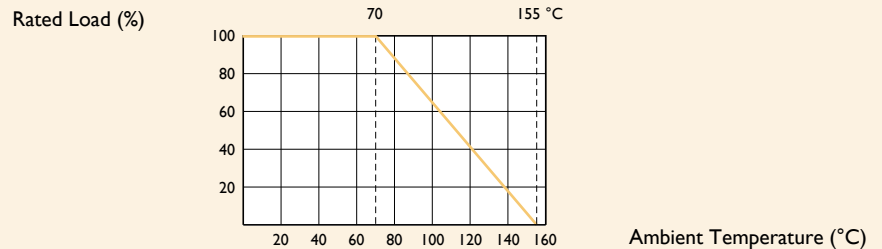

DIMENSIONS

Unit: mm

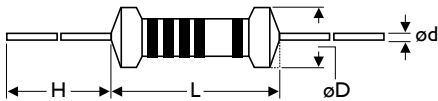

STYLE		DIMENSION			
Normal	Miniature	L	øD	H	ød
MFR-12	MFR25S	3.4±0.3	1.9±0.2	28±2.0	0.45±0.05
MFR-25	MFR50S	6.3±0.5	2.4±0.2	28±2.0	0.55±0.05
MFR-50	MFR1WS	9.0±0.5	3.3±0.3	26±2.0	0.55±0.05
MFR100	MFR2WS	11.5±1.0	4.5±0.5	35±2.0	0.8±0.05
MFR200	MFR3WS	15.5±1.0	5.0±0.5	33±2.0	0.8±0.05

Note:

ELECTRICAL CHARACTERISTICS

STYLE	MFR-12	MFR25S	MFR-25	MFR50S	MFR-50	MFRIWS	MFRI00	MFR2WS	MFR200	MFR3WS
Power Rating at 70°C	1/6W	1/4W		1/2W		1W		2W		3W
Maximum Working Voltage	200V		250V	300V	350V	400V	500V			
Maximum Overload Voltage	400V		500V	600V	700V	800V	1,000V			
Voltage Proof	300V	400V	500V			700V	1,000V			
Resistance Range	1 Ω - 10M Ω & 0 Ω for E24 & E96 series value									
Operating Temp. Range	-55°C to +155°C									
Temperature Coefficient	±15ppm/°C, ±25ppm/°C, ±50ppm/°C, ±100ppm/°C									

Note: Special value is available on request

ENVIRONMENTAL CHARACTERISTICS

PERFORMANCE TEST	TEST METHOD		APPRAISE
Short Time Overload	IEC 60115-1 4.13	2.5 times RCWV for 5 Sec.	±0.25%+0.05 Ω
Voltage Proof	IEC 60115-1 4.7	in V-block for 60 Sec., test voltage by type	By type
Temperature Coefficient	IEC 60115-1 4.8	-55°C to +155°C	By type
Insulation Resistance	IEC 60115-1 4.6	in V-block for 60 Sec.	>10,000M Ω
Solderability	IEC 60115-1 4.17	235±5°C for 3±0.5 Sec.	95% Min. coverage
Solvent Resistance of Marking	IEC 60115-1 4.30	IPA for 5±0.5 Min. with ultrasonic	No deterioration of coatings and markings
Robustness of Terminations	IEC 60115-1 4.16	Direct load for 10 Sec. in the direction of the terminal leads	≥2.5kg (24.5N)
Periodic-pulse Overload	IEC 60115-1 4.39	4 times RCWV 10,000 cycles (1 Sec. on, 25 Sec. off)	±1.0%+0.05 Ω
Damp Heat Steady State	IEC 60115-1 4.24	40±2°C, 90-95% RH for 56 days, loaded with 0.1 times RCWV	±1.5%+0.05 Ω
Endurance at 70°C	IEC 60115-1 4.25	70±2°C at RCWV for 1,000 Hr. (1.5 Hr. on, 0.5 Hr. off)	±1.5%+0.05 Ω
Temperature Cycling	IEC 60115-1 4.19	-55°C ⇄ Room Temp. ⇄ +155°C ⇄ Room Temp. (5 cycles)	±0.75%+0.05 Ω
Resistance to Soldering Heat	IEC 60115-1 4.18	260±3°C for 10±1 Sec., immersed to a point 3±0.5mm from the body	±0.25%+0.05 Ω

Note: Rated Continuous Working Voltage (RCWV) = $\sqrt{\text{Power Rating} \times \text{Resistance Value}}$

Metal Film Resistors

Precision Type

Normal & Miniature Style [MFP Series]



INTRODUCTION

The MFP Series Metal Film Precision Resistors are manufactured using a vacuum sputtering system to deposit multiple layers of mixed metal alloys and passivative materials onto a carefully treated high grade ceramic substrate. After a helical groove has been cut in the resistive layer, tinned connecting leads of electrolytic copper are welded to the end-caps. The resistors are coated with layers of blue color lacquer. Ultra high precision resistors, ultra high stability, ultra low temperature coefficient.

FEATURES

Power Rating	1/6W, 1/4W, 0.4W, 1/2W, 0.6W, 1W, 2W, 3W
Resistance Tolerance	±0.1%, ±0.25%, (±0.02%, ±0.05% on request)
T.C.R.	±15ppm/°C, ±25ppm/°C, (±5ppm/°C, ±10ppm/°C on request)

DERATING CURVE

For resistors operated in ambient temperatures above 70°C, power rating must be derated in accordance with the curve below.

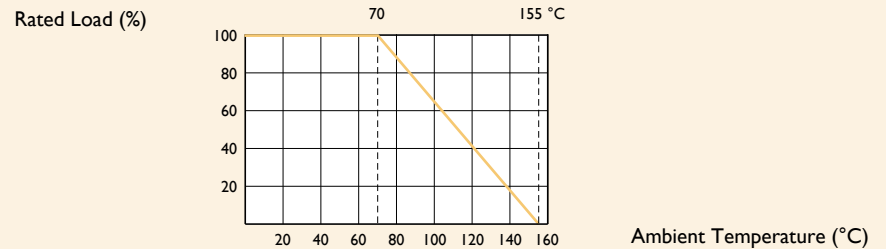

DIMENSIONS

Unit: mm

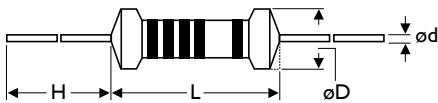

STYLE		DIMENSION			
Normal	Miniature	L	øD	H	ød
MFP-12	MFP25S	3.4±0.3	1.9±0.2	28±2.0	0.45±0.05
MFP204	-	3.4±0.3	1.9±0.2	28±2.0	0.45±0.05
MFP-25	MFP50S	6.3±0.5	2.4±0.2	28±2.0	0.55±0.05
MFP207	-	6.3±0.5	2.4±0.2	28±2.0	0.55±0.05
MFP-50	MFP1WS	9.0±0.5	3.3±0.3	26±2.0	0.55±0.05
MFP100	MFP2WS	11.5±1.0	4.5±0.5	35±2.0	0.8±0.05
MFP200	MFP3WS	15.5±1.0	5.0±0.5	33±2.0	0.8±0.05

Note:

ELECTRICAL CHARACTERISTICS

STYLE	MFP-12	MFP25S	MFP204	MFP-25	MFP50S	MFP207	MFP-50	MFPIWS	MFPI00	MFP2WS	MFP200	MFP3WS
Power Rating at 70°C	1/6W	1/4W	0.4W	1/4W	1/2W	0.6W	1/2W	1W		2W		3W
Maximum Working Voltage	150V	200V		250V			350V	400V	500V			
Maximum Overload Voltage	300V	400V		500V	600V		700V	800V	1,000V			
Voltage Proof	300V			500V				700V	1,000V			
Resistance Range	10 Ω - 1 M Ω for E192 series value											
Operating Temp. Range	-55°C to +155°C											
Temperature Coefficient	±15ppm/°C, ±25ppm/°C											

Note: Special value is available on request

ENVIRONMENTAL CHARACTERISTICS

PERFORMANCE TEST	TEST METHOD		APPRAISE
Short Time Overload	IEC 60115-1 4.13	2.5 times RCWV for 5 Sec.	±0.25%+0.05 Ω
Voltage Proof	IEC 60115-1 4.7	in V-block for 60 Sec., test voltage by type	By type
Temperature Coefficient	IEC 60115-1 4.8	-55°C to +155°C	By type
Insulation Resistance	IEC 60115-1 4.6	in V-block for 60 Sec.	>10,000M Ω
Solderability	IEC 60115-1 4.17	235±5°C for 3±0.5 Sec.	95% Min. coverage
Solvent Resistance of Marking	IEC 60115-1 4.30	IPA for 5±0.5 Min. with ultrasonic	No deterioration of coatings and markings
Robustness of Terminations	IEC 60115-1 4.16	Direct load for 10 Sec. in the direction of the terminal leads	≥2.5kg (24.5N)
Periodic-pulse Overload	IEC 60115-1 4.39	4 times RCWV 10,000 cycles (1 Sec. on, 25 Sec. off)	±1.0%+0.05 Ω
Damp Heat Steady State	IEC 60115-1 4.24	40±2°C, 90-95% RH for 56 days, loaded with 0.1 times RCWV	±1.5%+0.05 Ω
Endurance at 70°C	IEC 60115-1 4.25	70±2°C at RCWV for 1,000 Hr. (1.5 Hr. on, 0.5 Hr. off)	±1.5%+0.05 Ω
Temperature Cycling	IEC 60115-1 4.19	-55°C ⇌ Room Temp. ⇌ +155°C ⇌ Room Temp. (5 cycles)	±0.75%+0.05 Ω
Resistance to Soldering Heat	IEC 60115-1 4.18	260±3°C for 10±1 Sec., immersed to a point 3±0.5mm from the body	±0.25%+0.05 Ω

Note: Rated Continuous Working Voltage (RCWV) = $\sqrt{\text{Power Rating} \times \text{Resistance Value}}$

Metal Film Resistors

Professional Type

Miniature Style [MF0 Series]

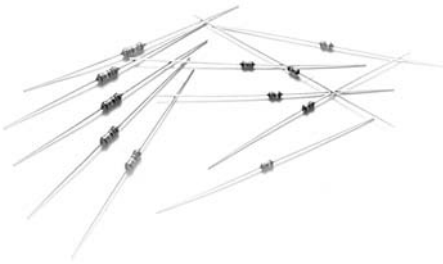

INTRODUCTION

The MF0 Series Metal Film Professional Resistors are manufactured using a vacuum sputtering system to deposit multiple layers of mixed metal alloys and passivative materials onto a carefully treated high grade ceramic substrate. After a helical groove has been cut in the resistive layer; tinned connecting leads of electrolytic copper are welded to the end-caps. The resistors are coated with layers of blue color lacquer.

FEATURES

Power Rating	0.4W, 0.6W
Resistance Tolerance	±0.5%, ±1%, ±5%
T.C.R.	±50ppm/°C

DERATING CURVE

For resistors operated in ambient temperatures above 70°C, power rating must be derated in accordance with the curve below.

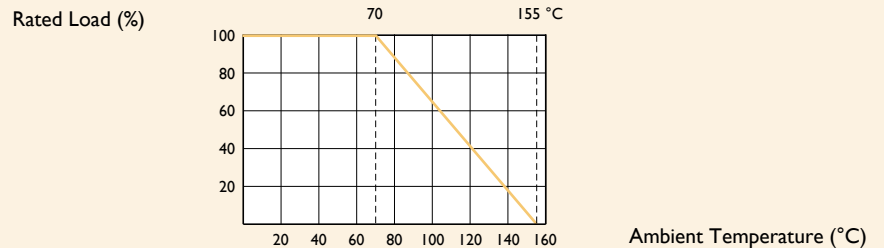

DIMENSIONS

Unit: mm

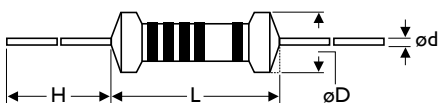

STYLE	DIMENSION			
	L	øD	H	ød
Miniature				
MF0204	3.4±0.3	1.9±0.2	28±2.0	0.45±0.05
MF0207	6.3±0.5	2.4±0.2	28±2.0	0.55±0.05

Note:

ELECTRICAL CHARACTERISTICS

STYLE	MF0204	MF0207
Power Rating at 70°C	0.4W	0.6W
Maximum Working Voltage	250V	350V
Maximum Overload Voltage	500V	700V
Voltage Proof	300V	500V
Resistance Range	1 Ω - 10M Ω & 0 Ω for E24 & E96 series value	
Operating Temp. Range	-55°C to +155°C	
Temperature Coefficient	±50ppm/°C	

Note: Special value is available on request

ENVIRONMENTAL CHARACTERISTICS

PERFORMANCE TEST	TEST METHOD		APPRAISE
Short Time Overload	IEC 60115-1 4.13	2.5 times RCWV for 5 Sec.	±0.25%+0.05 Ω
Voltage Proof	IEC 60115-1 4.7	in V-block for 60 Sec., test voltage by type	By type
Temperature Coefficient	IEC 60115-1 4.8	-55°C to +155°C	By type
Insulation Resistance	IEC 60115-1 4.6	in V-block for 60 Sec.	>10,000M Ω
Solderability	IEC 60115-1 4.17	235±5°C for 3±0.5 Sec.	95% Min. coverage
Solvent Resistance of Marking	IEC 60115-1 4.30	IPA for 5±0.5 Min. with ultrasonic	No deterioration of coatings and markings
Robustness of Terminations	IEC 60115-1 4.16	Direct load for 10 Sec. in the direction of the terminal leads	≥2.5kg (24.5N)
Periodic-pulse Overload	IEC 60115-1 4.39	4 times RCWV 10,000 cycles (1 Sec. on, 25 Sec. off)	±1.0%+0.05 Ω
Damp Heat Steady State	IEC 60115-1 4.24	40±2°C, 90-95% RH for 56 days, loaded with 0.1 times RCWV	±1.5%+0.05 Ω
Endurance at 70°C	IEC 60115-1 4.25	70±2°C at RCWV for 1,000 Hr. (1.5 Hr. on, 0.5 Hr. off)	±1.5%+0.05 Ω
Temperature Cycling	IEC 60115-1 4.19	-55°C ⇌ Room Temp. ⇌ +155°C ⇌ Room Temp. (5 cycles)	±0.75%+0.05 Ω
Resistance to Soldering Heat	IEC 60115-1 4.18	260±3°C for 10±1 Sec., immersed to a point 3±0.5mm from the body	±0.25%+0.05 Ω

Note: Rated Continuous Working Voltage (RCWV) = $\sqrt{\text{Power Rating} \times \text{Resistance Value}}$

Metal Film Resistors

Flame-Proof Type

Normal & Miniature Style [FMF Series]



INTRODUCTION

The FMF Series Metal Film Flame-Proof Resistors are manufactured using a vacuum sputtering system to deposit multiple layers of mixed metal alloys and passivative materials onto a carefully treated high grade ceramic substrate. After a helical groove has been cut in the resistive layer; tinned connecting leads of electrolytic copper are welded to the end-caps. The resistors are coated with layers of gray color lacquer.

FEATURES

Power Rating	1/4W, 1/2W, 1W, 2W, 3W
Resistance Tolerance	±1%
T.C.R.	±50ppm/°C, ±100ppm/°C
Flameproof Multi-layer Coating Meets	UL-94V-0
Flameproof Feature Meets Overload Test	UL-1412

DERATING CURVE

For resistors operated in ambient temperatures above 70°C, power rating must be derated in accordance with the curve below.

Rated Load (%)

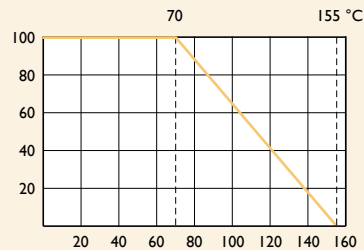

Ambient Temperature (°C)

DIMENSIONS

Unit: mm

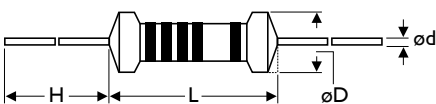

STYLE		DIMENSION			
Normal	Miniature	L	øD	H	ød
FMF-25	FMF50S	6.3±0.5	2.4±0.2	28±2.0	0.55±0.05
FMF-50	FMF1WS	9.0±0.5	3.3±0.3	26±2.0	0.55±0.05
FMF100	FMF2WS	11.5±1.0	4.5±0.5	35±2.0	0.8±0.05
FMF200	FMF3WS	15.5±1.0	5.0±0.5	33±2.0	0.8±0.05

Note:

ELECTRICAL CHARACTERISTICS

STYLE	FMF-25	FMF50S	FMF-50	FMFIWS	FMFI00	FMF2WS	FMF200	FMF3WS
Power Rating at 70°C	1/4W	1/2W		1W		2W		3W
Maximum Working Voltage	250V	300V	350V	400V	500V			
Maximum Overload Voltage	500V	600V	700V	800V	1,000V			
Voltage Proof	400V		500V	600V	750V			
Resistance Range	1 Ω - 10M Ω & 0 Ω for E24 & E96 series value							
Operating Temp. Range	-55°C to +155°C							
Temperature Coefficient	±50ppm/°C, ±100ppm/°C							

Note: Special value is available on request

ENVIRONMENTAL CHARACTERISTICS

PERFORMANCE TEST	TEST METHOD		APPRAISE
Short Time Overload	IEC 60115-1 4.13	2.5 times RCWV for 5 Sec.	±0.25%+0.05 Ω
Voltage Proof	IEC 60115-1 4.7	in V-block for 60 Sec., test voltage by type	By type
Temperature Coefficient	IEC 60115-1 4.8	-55°C to +155°C	By type
Insulation Resistance	IEC 60115-1 4.6	in V-block for 60 Sec.	>1,000M Ω
Solderability	IEC 60115-1 4.17	235±5°C for 3±0.5 Sec.	95% Min. coverage
Solvent Resistance of Marking	IEC 60115-1 4.30	IPA for 5±0.5 Min. with ultrasonic	No deterioration of coatings and markings
Robustness of Terminations	IEC 60115-1 4.16	Direct load for 10 Sec. in the direction of the terminal leads	≥2.5kg (24.5N)
Periodic-pulse Overload	IEC 60115-1 4.39	4 times RCWV 10,000 cycles (1 Sec. on, 25 Sec. off)	±1.0%+0.05 Ω
Damp Heat Steady State	IEC 60115-1 4.24	40±2°C, 90-95% RH for 56 days, loaded with 0.1 times RCWV	±1.5%+0.05 Ω
Endurance at 70°C	IEC 60115-1 4.25	70±2°C at RCWV for 1,000 Hr. (1.5 Hr. on, 0.5 Hr. off)	±1.5%+0.05 Ω
Temperature Cycling	IEC 60115-1 4.19	-55°C ⇌ Room Temp. ⇌ +155°C ⇌ Room Temp. (5 cycles)	±0.75%+0.05 Ω
Resistance to Soldering Heat	IEC 60115-1 4.18	260±3°C for 10±1 Sec., immersed to a point 3±0.5mm from the body	±0.25%+0.05 Ω
Accidental Overload Test	IEC 60115-1 4.26	4 times RCWV for 1 Min.	No evidence of flaming or arcing

Note: Rated Continuous Working Voltage (RCWV) = $\sqrt{\text{Power Rating} \times \text{Resistance Value}}$

Metal Film Resistors

Professional & Flame-Proof Type

Miniature Style [FM0 Series]

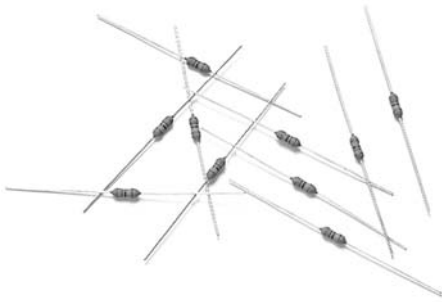

INTRODUCTION

The FM0 Series Metal Film Professional & Flame-Proof Resistors are manufactured using a vacuum sputtering system to deposit multiple layers of mixed metal alloys and passivative materials onto a carefully treated high grade ceramic substrate. After a helical groove has been cut in the resistive layer; tinned connecting leads of electrolytic copper are welded to the end-caps. The resistors are coated with layers of light green color lacquer.

FEATURES

Power Rating	0.4W, 0.6W
Resistance Tolerance	±1%, ±5%
T.C.R.	±50ppm/°C
Flameproof Multi-layer Coating Meets	UL-94V-0
Flameproof Feature Meets Overload Test	UL-1412

DERATING CURVE

For resistors operated in ambient temperatures above 70°C, power rating must be derated in accordance with the curve below.

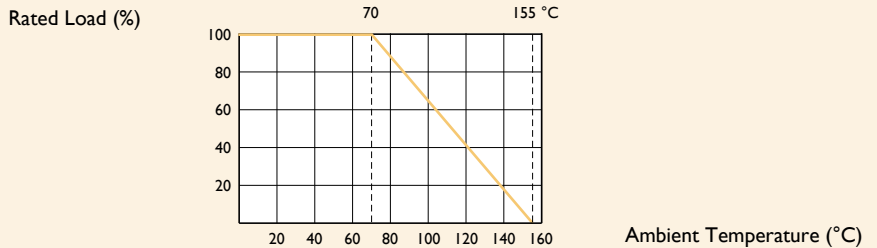

DIMENSIONS

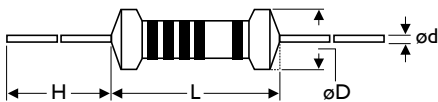

Unit: mm

STYLE	DIMENSION			
	L	øD	H	ød
Miniature				
FM0204	3.4±0.3	1.9±0.2	28±2.0	0.45±0.05
FM0207	6.3±0.5	2.4±0.2	28±2.0	0.55±0.05

Note:

ELECTRICAL CHARACTERISTICS

STYLE	FM0204	FM0207
Power Rating at 70°C	0.4W	0.6W
Maximum Working Voltage	200V	300V
Maximum Overload Voltage	400V	600V
Voltage Proof	300V	500V
Resistance Range	1 Ω - 10M Ω & 0 Ω for E24 & E96 series value	
Operating Temp. Range	-55°C to +155°C	
Temperature Coefficient	±50ppm/°C	

Note: Special value is available on request

ENVIRONMENTAL CHARACTERISTICS

PERFORMANCE TEST	TEST METHOD	APPRAISE
Short Time Overload	IEC 60115-1 4.13 2.5 times RCWV for 5 Sec.	±0.25%+0.05 Ω
Voltage Proof	IEC 60115-1 4.7 in V-block for 60 Sec., test voltage by type	By type
Temperature Coefficient	IEC 60115-1 4.8 -55°C to +155°C	By type
Insulation Resistance	IEC 60115-1 4.6 in V-block for 60 Sec.	>1,000M Ω
Solderability	IEC 60115-1 4.17 235±5°C for 3±0.5 Sec.	95% Min. coverage
Solvent Resistance of Marking	IEC 60115-1 4.30 IPA for 5±0.5 Min. with ultrasonic	No deterioration of coatings and markings
Robustness of Terminations	IEC 60115-1 4.16 Direct load for 10 Sec. in the direction of the terminal leads	≥2.5kg (24.5N)
Periodic-pulse Overload	IEC 60115-1 4.39 4 times RCWV 10,000 cycles (1 Sec. on, 25 Sec. off)	±1.0%+0.05 Ω
Damp Heat Steady State	IEC 60115-1 4.24 40±2°C, 90-95% RH for 56 days, loaded with 0.1 times RCWV	±1.5%+0.05 Ω
Endurance at 70°C	IEC 60115-1 4.25 70±2°C at RCWV for 1,000 Hr. (1.5 Hr. on, 0.5 Hr. off)	±1.5%+0.05 Ω
Temperature Cycling	IEC 60115-1 4.19 -55°C ⇌ Room Temp. ⇌ +155°C ⇌ Room Temp. (5 cycles)	±0.75%+0.05 Ω
Resistance to Soldering Heat	IEC 60115-1 4.18 260±3°C for 10±1 Sec., immersed to a point 3±0.5mm from the body	±0.25%+0.05 Ω
Accidental Overload Test	IEC 60115-1 4.26 4 times RCWV for 1 Min.	No evidence of flaming or arcing

Note: Rated Continuous Working Voltage (RCWV) = $\sqrt{\text{Power Rating} \times \text{Resistance Value}}$

Metal Film Resistors

High Power Type

Ultra Miniature Style [FMP Series]

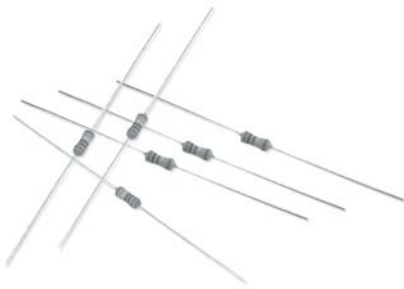

INTRODUCTION

The FMP Series Metal Film High Power Resistors are manufactured using a vacuum sputtering system to deposit multiple layers of mixed metal alloys and passivative materials onto a carefully treated high grade ceramic substrate. After a helical groove has been cut in the resistive layer; tinned connecting leads of electrolytic copper are welded to the end-caps. The resistors are coated with layers of pink color lacquer.

FEATURES

Power Rating	1/2W, 1W, 2W, 3W, 4W
Resistance Tolerance	±1%, ±5%
T.C.R.	±100ppm/°C
Flameproof Multi-layer Coating Meets	UL-94V-0
Flameproof Feature Meets Overload Test	UL-1412

DERATING CURVE

For resistors operated in ambient temperatures above 70°C, power rating must be derated in accordance with the curve below.

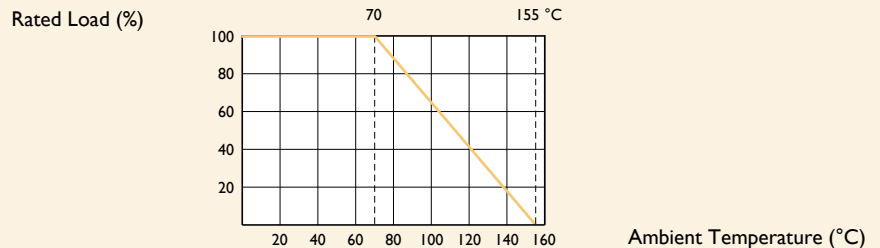

DIMENSIONS

Unit: mm

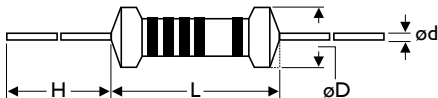

STYLE	DIMENSION			
	L	øD	H	ød
Ultra Miniature				
FMP-50	3.4±0.3	1.9±0.2	28±2.0	0.45±0.05
FMP100	6.3±0.5	2.4±0.2	28±2.0	0.55±0.05
FMP200	9.0±0.5	3.9±0.3	26±2.0	0.55±0.05
FMP3WS	11.5±1.0	4.5±0.5	35±2.0	0.8±0.05
FMP300	15.5±1.0	5.0±0.5	33±2.0	0.8±0.05
FMP4WV	17.0±1.0	7.5±0.5	32±2.0	0.8±0.05

Note:

ELECTRICAL CHARACTERISTICS

STYLE	FMP-50	FMP100	FMP200	FMP3WS	FMP300	FMP4WV
Power Rating at 70°C	1/2W	1W	2W	3W		4W
Maximum Working Voltage	200V	350V	500V		750V	
Maximum Overload Voltage	400V	600V	700V		1,000V	
Voltage Proof	300V	500V			750V	
Resistance Range	1 Ω - 10M Ω & 0 Ω for E24 & E96 series value					
Operating Temp. Range	-55°C to +155°C					
Temperature Coefficient	±100ppm/°C					

Note: Special value is available on request

ENVIRONMENTAL CHARACTERISTICS

PERFORMANCE TEST	TEST METHOD	APPRAISE
Short Time Overload	IEC 60115-1 4.13 2.5 times RCWV for 5 Sec.	±0.5%+0.05 Ω
Voltage Proof	IEC 60115-1 4.7 in V-block for 60 Sec., test voltage by type	By type
Temperature Coefficient	IEC 60115-1 4.8 -55°C to +155°C	By type
Insulation Resistance	IEC 60115-1 4.6 in V-block for 60 Sec.	>1,000M Ω
Solderability	IEC 60115-1 4.17 235±5°C for 3±0.5 Sec.	95% Min. coverage
Solvent Resistance of Marking	IEC 60115-1 4.30 IPA for 5±0.5 Min. with ultrasonic	No deterioration of coatings and markings
Robustness of Terminations	IEC 60115-1 4.16 Direct load for 10 Sec. in the direction of the terminal leads	≥2.5kg (24.5N)
Periodic-pulse Overload	IEC 60115-1 4.39 4 times RCWV 10,000 cycles (1 Sec. on, 25 Sec. off)	±1.0%+0.05 Ω
Damp Heat Steady State	IEC 60115-1 4.24 40±2°C, 90-95% RH for 56 days, loaded with 0.1 times RCWV	±2.0%+0.05 Ω
Endurance at 70°C	IEC 60115-1 4.25 70±2°C at RCWV for 1,000 Hr. (1.5 Hr. on, 0.5 Hr. off)	±2.0%+0.05 Ω
Temperature Cycling	IEC 60115-1 4.19 -55°C ⇌ Room Temp. ⇌ +155°C ⇌ Room Temp. (5 cycles)	±1.0%+0.05 Ω
Resistance to Soldering Heat	IEC 60115-1 4.18 260±3°C for 10±1 Sec., immersed to a point 3±0.5mm from the body	±0.25%+0.05 Ω
Accidental Overload Test	IEC 60115-1 4.26 4 times RCWV for 1 Min.	No evidence of flaming or arcing

Note: Rated Continuous Working Voltage (RCWV) = $\sqrt{\text{Power Rating} \times \text{Resistance Value}}$

Metal Film Resistors

Fusible & Flame-Proof Type

Normal & Miniature Style [FRM Series]

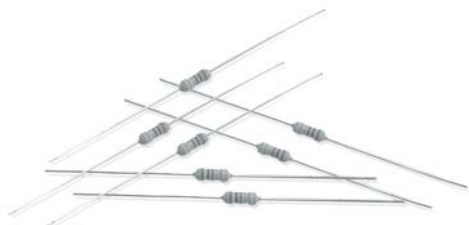

INTRODUCTION

The FRM Series Metal Film Fusible & Flame-Proof Resistors are manufactured using a vacuum sputtering system to deposit multiple layers of mixed metal alloys and passivative materials onto a carefully treated high grade ceramic substrate. After a helical groove has been cut in the resistive layer, tinned connecting leads of electrolytic copper are welded to the end-caps. The resistors are coated with layers of gray color lacquer for normal size & pink color lacquer for miniature size. Overload protection without risk of fire. Wide range of overload currents.

DIMENSIONS

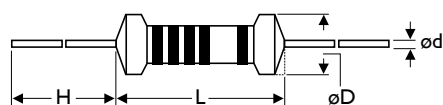

5th color code: white

FEATURES

Power Rating	1/4W, 1/2W, 1W, 2W, 3W
Resistance Tolerance	±2%, ±5%
T.C.R.	±200ppm/°C
Flameproof Multi-layer Coating Meets	UL-94V-0
Flameproof Feature Meets Overload Test	UL-1412

DERATING CURVE

For resistors operated in ambient temperatures above 70°C, power rating must be derated in accordance with the curve below.

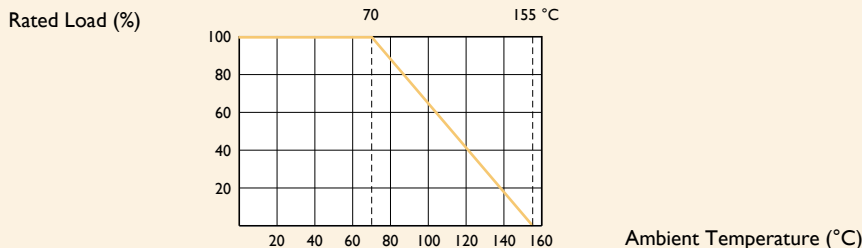

FUSING CHARACTERISTICS

$R \leq 2.0 \Omega$ Fusing time within 60 seconds at 36 times of rated power

$R \geq 2.2 \Omega$ Fusing time within 60 seconds at 25 times of rated power

Fusing residual resistive value at least 100 times rated resistance

Unit: mm

STYLE		DIMENSION			
Normal	Miniature	L	øD	H	ød
FRM-25	FRM50S	6.3±0.5	2.4±0.2	28±2.0	0.55±0.05
FRM-50	FRM1WS	9.0±0.5	3.3±0.3	26±2.0	0.55±0.05
FRM100	FRM2WS	11.5±1.0	4.5±0.5	35±2.0	0.8±0.05
FRM200	FRM3WS	15.5±1.0	5.0±0.5	33±2.0	0.8±0.05

Note:

ELECTRICAL CHARACTERISTICS

STYLE	FRM-25	FRM50S	FRM-50	FRMIWS	FRMI00	FRM2WS	FRM200	FRM3WS
Power Rating at 70°C	1/4W	1/2W		1W		2W		3W
Maximum Working Voltage	200V		250V		300V		350V	
Maximum Overload Voltage	400V		500V		600V		700V	
Voltage Proof	250V				350V			
Resistance Range	4.7 Ω - 560 Ω (±2%) for E24 series value & 2.2 Ω - 560 Ω (±5%) for E24 series value							
Operating Temp. Range	-55°C to +155°C							
Temperature Coefficient	±200ppm/°C							

Note: Special value is available on request

ENVIRONMENTAL CHARACTERISTICS

PERFORMANCE TEST	TEST METHOD		APPRAISE
Short Time Overload	IEC 60115-1 4.13	2.5 times RCWV for 5 Sec.	±2.0%+0.05 Ω
Voltage Proof	IEC 60115-1 4.7	in V-block for 60 Sec., test voltage by type	By type
Temperature Coefficient	IEC 60115-1 4.8	-55°C to +155°C	By type
Insulation Resistance	IEC 60115-1 4.6	in V-block for 60 Sec.	>100M Ω
Solderability	IEC 60115-1 4.17	235±5°C for 3±0.5 Sec.	95% Min. coverage
Solvent Resistance of Marking	IEC 60115-1 4.30	IPA for 5±0.5 Min. with ultrasonic	No deterioration of coatings and markings
Robustness of Terminations	IEC 60115-1 4.16	Direct load for 10 Sec. in the direction of the terminal leads	≥2.5kg (24.5N)
Periodic-pulse Overload	IEC 60115-1 4.39	4 times RCWV 10,000 cycles (1 Sec. on, 25 Sec. off)	±1.0%+0.05 Ω
Damp Heat Steady State	IEC 60115-1 4.24	40±2°C, 90-95% RH for 56 days, loaded with 0.1 times RCWV	±5.0%+0.05 Ω
Endurance at 70°C	IEC 60115-1 4.25	70±2°C at RCWV for 1,000 Hr. (1.5 Hr. on, 0.5 Hr. off)	±5.0%+0.05 Ω
Temperature Cycling	IEC 60115-1 4.19	-55°C ⇄ Room Temp. ⇄ +155°C ⇄ Room Temp. (5 cycles)	±2.0%+0.05 Ω
Resistance to Soldering Heat	IEC 60115-1 4.18	260±3°C for 10±1 Sec., immersed to a point 3±0.5mm from the body	±1.0%+0.05 Ω
Accidental Overload Test	IEC 60115-1 4.26	4 times RCWV for 1 Min.	No evidence of flaming or arcing

Note: Rated Continuous Working Voltage (RCWV) = $\sqrt{\text{Power Rating} \times \text{Resistance Value}}$

Metal Film Resistors

Biased Humidity Type

Normal & Miniature Style [MFN Series]

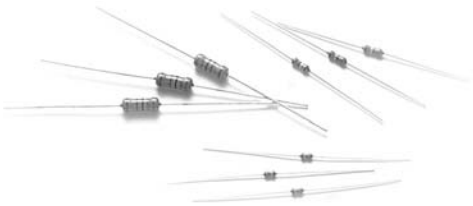

INTRODUCTION

The MFN Series Metal Film Biased Humidity Resistors are manufactured using a vacuum sputtering system to deposit multiple layers of mixed metal alloys and passivative materials onto a carefully treated high grade ceramic substrate. After a helical groove has been cut in the resistive layer; tinned connecting leads of electrolytic copper are welded to the end-caps. The resistors are coated with a specialized blue lacquer. Its processes and controls ensure the product is impervious to moisture.

FEATURES

Power Rating	1/6W, 1/4W, 1/2W, 1W, 2W, 3W
Resistance Tolerance	±0.5%, ±1%
T.C.R.	±15ppm/°C, ±25ppm/°C, ±50ppm/°C, ±100ppm/°C

DERATING CURVE

For resistors operated in ambient temperatures above 70°C, power rating must be derated in accordance with the curve below.

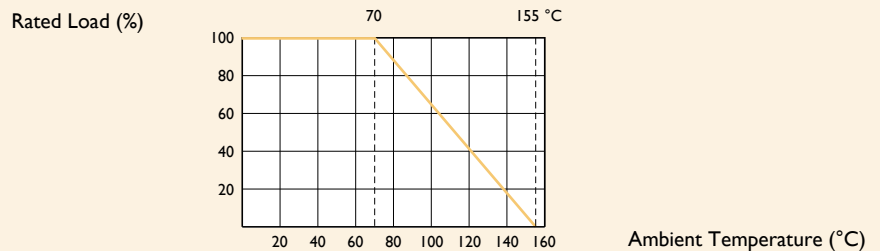

DIMENSIONS

Unit: mm

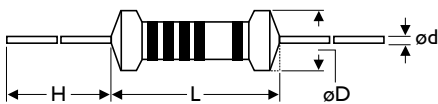

STYLE		DIMENSION			
Normal	Miniature	L	øD	H	ød
MFN-12	MFN25S	3.4±0.3	1.9±0.2	28±2.0	0.45±0.05
MFN-25	MFN50S	6.3±0.5	2.4±0.2	28±2.0	0.55±0.05
MFN-50	MFN1WS	9.0±0.5	3.3±0.3	26±2.0	0.55±0.05
MFN100	MFN2WS	11.5±1.0	4.5±0.5	35±2.0	0.8±0.05
MFN200	MFN3WS	15.5±1.0	5.0±0.5	33±2.0	0.8±0.05

Note:

ELECTRICAL CHARACTERISTICS

STYLE	MFN-12	MFN25S	MFN-25	MFN50S	MFN-50	MFNIWS	MFN100	MFN2WS	MFN200	MFN3WS
Power Rating at 70°C	1/6W	1/4W		1/2W		1W		2W		3W
Maximum Working Voltage	200V		250V	300V	350V	400V	500V			
Maximum Overload Voltage	400V		500V	600V	700V	800V	1,000V			
Voltage Proof	300V	400V	500V			700V	1,000V			
Resistance Range	1 Ω - 10M Ω & 0 Ω for E24 & E96 series value									
Operating Temp. Range	-55°C to +155°C									
Temperature Coefficient	±15ppm/°C, ±25ppm/°C, ±50ppm/°C, ±100ppm/°C									

Note: Special value is available on request

ENVIRONMENTAL CHARACTERISTICS

PERFORMANCE TEST	TEST METHOD	APPRAISE
Short Time Overload	IEC 60115-1 4.13 2.5 times RCWV for 5 Sec.	±0.25%+0.05 Ω
Voltage Proof	IEC 60115-1 4.7 in V-block for 60 Sec., test voltage by type	No breakdown or flashover
Temperature Coefficient	IEC 60115-1 4.8 -55°C to +155°C	By type
Insulation Resistance	IEC 60115-1 4.6 in V-block for 60 Sec.	> 10,000M
Solderability	IEC 60115-1 4.17 235±5°C for 3±0.5 Sec.	95% Min. coverage
Solvent Resistance of Marking	IEC 60115-1 4.30 IPA for 5±0.5 Min. with ultrasonic	No deterioration of coatings and markings
Robustness of Terminations	IEC 60115-1 4.16 Direct load for 10 Sec. in the direction of the terminal leads	≥2.5kg (24.5N)
Periodic-pulse Overload	IEC 60115-1 4.39 4 times RCWV 10,000 cycles (1 Sec. on, 25 Sec. off)	±1.0%+0.05 Ω
Damp Heat Steady State	IEC 60115-1 4.24 40±2°C, 90-95% RH for 56 days, loaded with 0.1 times RCWV	±1.5%+0.05 Ω
Endurance at 70°C	IEC 60115-1 4.25 70±2°C at RCWV for 1,000 Hr; (1.5 Hr: on, 0.5 Hr: off)	±1.5%+0.05 Ω
Temperature Cycling	IEC 60115-1 4.19 -55°C ⇌ Room Temp. ⇌ +155°C ⇌ Room Temp. (5 cycles)	±0.75%+0.05 Ω
Resistance to Soldering Heat	IEC 60115-1 4.18 260±3°C for 10±1 Sec., immersed to a point 3±0.5mm from the body	±0.25%+0.05 Ω

Note: Rated Continuous Working Voltage (RCWV) = $\sqrt{\text{Power Rating} \times \text{Resistance Value}}$

Metal Film Resistors

HID Lamps Type

Normal Style [HTM Series]



INTRODUCTION

The HTM Series Metal Film Resistors are manufactured using a vacuum sputtering system to deposit multiple layers of mixed metal alloys onto a carefully treated high grade ceramic substrate. After a helical groove has been cut in the resistive layer, steel copper plated wires are welded to the end-caps. The resistor is not coated. This is a special product for HID lamps, providing high power within a small package and saving space.

FEATURES

Power Rating	2W, 2.5W
Resistance Tolerance	±5%
T.C.R.	±250ppm/°C

DIMENSIONS

Unit: mm

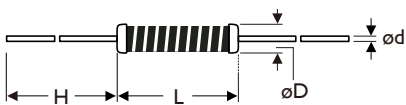

STYLE	DIMENSION			
	L	øD	H	ød
Normal				
HTM200	8.5±0.3	3.5±0.2	26±2.0	0.8±0.05
HTM250	15.5±0.3	Max. 3.55	33±2.0	0.8±0.05

Note:

ELECTRICAL CHARACTERISTICS

STYLE	HTM200	HTM250
Power Rating at 70°C	2W	2.5W
Maximum Working Voltage	500V	750V
Resistance Range	2K Ω - 68K Ω for E24 series value	
Temperature Coefficient	±250ppm/°C	

Note: Special value is available on request

ENVIRONMENTAL CHARACTERISTICS

PERFORMANCE TEST	TEST METHOD		APPRAISE
Short Time Overload	IEC 60115-1 4.13	2.5 times RCWV for 5 Sec.	±0.25%+0.05 Ω
Temperature Coefficient	IEC 60115-1 4.8	-55°C to +155°C	±250ppm/°C
Robustness of Terminations	IEC 60115-1 4.16	Direct load for 10 Sec. in the direction of the terminal leads	≥4kg (39.2N)
Periodic-pulse Overload	IEC 60115-1 4.39	4 times RCWV 10,000 cycles (1 Sec. on, 25 Sec. off)	±1.0%+0.05 Ω
Endurance at 70°C	IEC 60115-1 4.25	70±2°C at RCWV for 1,000 Hr: (1.5 Hr. on, 0.5 Hr. off)	±1.5%+0.05 Ω
Temperature Cycling	IEC 60115-1 4.19	-55°C ⇒ Room Temp. ⇒ +155°C ⇒ Room Temp. (5 cycles)	±0.75%+0.05 Ω

Note: Rated Continuous Working Voltage (RCWV) = $\sqrt{\text{Power Rating} \times \text{Resistance Value}}$

Metal Oxide Film Resistors

Flame-Proof Type

Normal & Miniature Style [RSF Series]

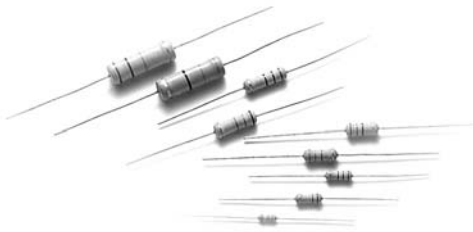

INTRODUCTION

The RSF Series Metal Oxide Film Flame-Proof Resistors offer excellent performance in applications where stability and uniformity of characteristics are desired. They provide lower cost alternatives to Carbon Composition Resistors and General Purpose Metal Films. Metal Oxides also can replace many low power General Purpose wirewound applications, saving both money and time, with shorter delivery cycles. The normal style & the miniature style of RSF series are coated with layers of gray and pink colors flame-proof lacquer respectively.

FEATURES

Power Rating	1/4W, 1/2W, 1W, 2W, 3W, 5W
Resistance Tolerance	±2%, ±5%
T.C.R.	±300ppm/°C
Flameproof Multi-layer Coating Meets	UL-94V-0
Flameproof Feature Meets Overload Test	UL-1412

DERATING CURVE

For resistors operated in ambient temperatures above 70°C, power rating must be derated in accordance with the curve below.

Rated Load (%)

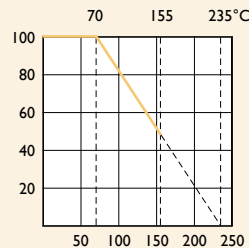

Ambient Temperature (°C)

DIMENSIONS

Unit: mm

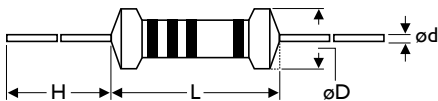

STYLE		DIMENSION			
Normal	Miniature	L	øD	H	ød
RSF-25	RSF50S	6.3±0.5	2.4±0.2	28±2.0	0.55±0.05
RSF-50	RSF1WS	9.0±0.5	3.3±0.3	26±2.0	0.55±0.05
RSF100	RSF2WS	11.5±1.0	4.5±0.5	35±2.0	0.8±0.05
RSF200	RSF3WS	15.5±1.0	5.0±0.5	33±2.0	0.8±0.05
RSF3WM	RSF5SS	17.5±1.0	6.5±1.0	32±2.0	0.8±0.05
RSF300	RSF5WS	24.5±1.0	8.5±1.0	38±2.0	0.8±0.05
RSF500	-	24.5±1.0	8.5±1.0	38±2.0	0.8±0.05

Note: RSF1WS (for MB Type) ød = 0.8±0.05mm

ELECTRICAL CHARACTERISTICS

NORMAL STYLE

STYLE	RSF-25	RSF-50	RSF100	RSF200	RSF3WM	RSF300	RSF500
Power Rating at 70°C	1/4W	1/2W	1W	2W	3W		5W
Maximum Working Voltage	200V	250V	350V		450V	500V	750V
Maximum Overload Voltage	300V	400V	600V		700V	800V	1,000V
Voltage Proof	250V	350V	500V		600V	700V	750V
Resistance Range	1 Ω - 1M Ω & 0 Ω for E24 series value						
Operating Temp. Range	-55°C to +235°C						
Temperature Coefficient	±300ppm/°C						

MINIATURE STYLE

STYLE	RSF50S	RSFIWS	RSF2WS	RSF3WS	RSF5SS	RSF5WS
Power Rating at 70°C	1/2W	1W	2W	3W	5W	
Maximum Working Voltage	250V	300V	350V		500V	700V
Maximum Overload Voltage	400V	500V	600V		800V	900V
Voltage Proof	350V	400V	500V		700V	700V
Resistance Range	1 Ω - 1M Ω & 0 Ω for E24 series value					
Operating Temp. Range	-55°C to +235°C					
Temperature Coefficient	±300ppm/°C					

Note: Special value is available on request

ENVIRONMENTAL CHARACTERISTICS

PERFORMANCE TEST	TEST METHOD		APPRAISE
Short Time Overload	IEC 60115-1 4.13	2.5 times RCWV for 5 Sec.	±1.0%+0.05 Ω for normal style ±2.0%+0.05 Ω for miniature style
Voltage Proof	IEC 60115-1 4.7	in V-block for 60 Sec., test voltage by type	By type
Temperature Coefficient	IEC 60115-1 4.8	-55°C to +155°C	By type
Insulation Resistance	IEC 60115-1 4.6	in V-block for 60 Sec.	>1,000M Ω
Solderability	IEC 60115-1 4.17	235±5°C for 3±0.5 Sec.	95% Min. coverage
Solvent Resistance of Marking	IEC 60115-1 4.30	IPA for 5±0.5 Min. with ultrasonic	No deterioration of coatings and markings
Robustness of Terminations	IEC 60115-1 4.16	Direct load for 10 Sec. in the direction of the terminal leads	≥2.5kg (24.5N)
Periodic-pulse Overload	IEC 60115-1 4.39	4 times RCWV 10,000 cycles (1 Sec. on, 25 Sec. off)	±2.0%+0.05 Ω
Damp Heat Steady State	IEC 60115-1 4.24	40±2°C, 90-95% RH for 56 days, loaded with 0.1 times RCWV	±5.0%+0.05 Ω
Endurance at 70°C	IEC 60115-1 4.25	70±2°C at RCWV for 1,000 Hr. (1.5 Hr. on, 0.5 Hr. off)	±5.0%+0.05 Ω
Temperature Cycling	IEC 60115-1 4.19	-55°C ⇄ Room Temp. ⇄ +155°C ⇄ Room Temp. (5 cycles)	±1.0%+0.05 Ω
Resistance to Soldering Heat	IEC 60115-1 4.18	260±3°C for 10±1 Sec., immersed to a point 3±0.5mm from the body	±1.0%+0.05 Ω
Accidental Overload Test	IEC 60115-1 4.26	4 times RCWV for 1 Min.	No evidence of flaming or arcing

Note: Rated Continuous Working Voltage (RCWV) = $\sqrt{\text{Power Rating} \times \text{Resistance Value}}$

Metal Oxide Film Resistors

Low-Inductive & Flame-Proof Type

Normal & Miniature Style [LIR Series]

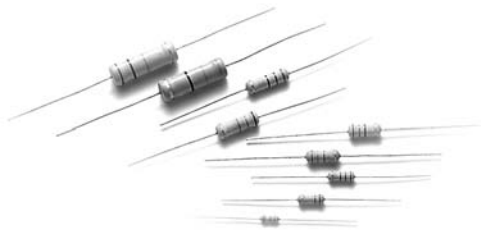

INTRODUCTION

The LIR Series Metal Oxide Film Low-Inductive & Flame-Proof Resistors offer excellent performance in applications where stability and uniformity of characteristics are desired. They provide lower cost alternatives to Carbon Composition Resistors and General Purpose Metal Films. Metal Oxides also can replace many low power General Purpose wirewound applications, saving both money and time, with shorter delivery cycles. The normal style & the miniature style of LIR series are coated with layers of gray and pink colors flame-proof lacquer respectively.

FEATURES

Power Rating	1/4W, 1/2W, 1W, 2W
Resistance Tolerance	±5%, ±10%
T.C.R.	±300ppm/°C
Flameproof Multi-layer Coating Meets	UL-94V-0
Flameproof Feature Meets Overload Test	UL-1412

DERATING CURVE

For resistors operated in ambient temperatures above 70°C, power rating must be derated in accordance with the curve below.

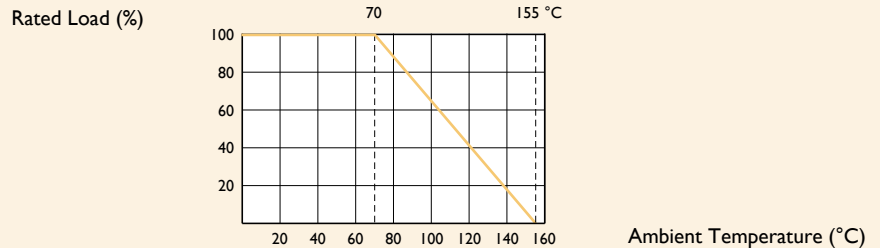

DIMENSIONS

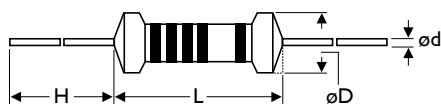

5th color code: blue

Unit: mm

STYLE		DIMENSION			
Normal	Miniature	L	øD	H	ød
LIR-25	LIR50S	6.3±0.5	2.4±0.2	28±2.0	0.55±0.05
LIR-50	LIR1WS	9.0±0.5	3.3±0.3	26±2.0	0.55±0.05
LIR100	LIR2WS	11.5±1.0	4.5±0.5	35±2.0	0.8±0.05
LIR200	LIR3WS	15.5±1.0	5.0±0.5	33±2.0	0.8±0.05

Note: LIR1WS (for MB Type) ød 0.8±0.0 mm

ELECTRICAL CHARACTERISTICS

NORMAL STYLE

STYLE	LIR-25	LIR-50	LIR100	LIR200
Power Rating at 70°C	1/4W	1/2W	1W	2W
Maximum Working Voltage	200V	250V	350V	
Maximum Overload Voltage	300V	400V	600V	
Voltage Proof	250V	350V	500V	
Resistance Range	1 Ω - 100K Ω & 0 Ω for E24 resistance value			
Operating Temp. Range	-55°C to +155°C			
Temperature Coefficient	±300ppm/°C			

MINIATURE STYLE

STYLE	LIR50S	LIR1WS	LIR2WS	LIR3WS
Power Rating at 70°C	1/2W	1W	2W	3W
Maximum Working Voltage	250V	300V	350V	
Maximum Overload Voltage	400V	500V	600V	
Voltage Proof	350V	400V	500V	
Resistance Range	1 Ω - 100K Ω & 0 Ω for E24 resistance value			
Operating Temp. Range	-55°C to +155°C			
Temperature Coefficient	±300ppm/°C			

Note: Special value is available on request

ENVIRONMENTAL CHARACTERISTICS

PERFORMANCE TEST	TEST METHOD		APPRAISE
Short Time Overload	IEC 60115-1 4.13	2.5 times RCWV for 5 Sec.	±1.0%+0.05 Ω for normal style ±2.0%+0.05 Ω for miniature style
Voltage Proof	IEC 60115-1 4.7	in V-block for 60 Sec., test voltage by type	By type
Temperature Coefficient	IEC 60115-1 4.8	-55°C to +155°C	By type
Insulation Resistance	IEC 60115-1 4.6	in V-block for 60 Sec.	>1,000M Ω
Solderability	IEC 60115-1 4.17	235±5°C for 3±0.5 Sec.	95% Min. coverage
Solvent Resistance of Marking	IEC 60115-1 4.30	IPA for 5±0.5 Min. with ultrasonic	No deterioration of coatings and markings
Robustness of Terminations	IEC 60115-1 4.16	Direct load for 10 Sec. in the direction of the terminal leads	≥2.5kg (24.5N)
Periodic-pulse Overload	IEC 60115-1 4.39	4 times RCWV 10,000 cycles (1 Sec. on, 25 Sec. off)	±2.0%+0.05 Ω
Damp Heat Steady State	IEC 60115-1 4.24	40±2°C, 90-95% RH for 56 days, loaded with 0.1 times RCWV	±5.0%+0.05 Ω
Endurance at 70°C	IEC 60115-1 4.25	70±2°C at RCWV for 1,000 Hr. (1.5 Hr. on, 0.5 Hr. off)	±5.0%+0.05 Ω
Temperature Cycling	IEC 60115-1 4.19	-55°C ⇌ Room Temp. ⇌ +155°C ⇌ Room Temp. (5 cycles)	±1.0%+0.05 Ω
Resistance to Soldering Heat	IEC 60115-1 4.18	260±3°C for 10±1 Sec., immersed to a point 3±0.5mm from the body	±1.0%+0.05 Ω
Accidental Overload Test	IEC 60115-1 4.26	4 times RCWV for 1 Min.	No evidence of flaming or arcing

Note: Rated Continuous Working Voltage (RCWV) = $\sqrt{\text{Power Rating} \times \text{Resistance Value}}$

Melf Metal Film Resistors

General Type

Normal & Miniature Style [MMF Series]



INTRODUCTION

The MMF Series Melf Metal Film Resistors are manufactured using a vacuum sputtering system to deposit multiple layers of mixed metal alloys and passivative materials onto a carefully treated high grade ceramic substrate. After a helical groove has been cut in the resistive layer, SMD enabled structure. The resistors are coated with layers of blue color lacquer.

FEATURES

Power Rating	1/6W, 1/4W, 0.4W, 1/2W, 0.6W, 1W
Resistance Tolerance	±0.1%, ±0.25%, ±0.5%, ±1%, ±2%, ±5%
T.C.R.	±15ppm/°C, ±25ppm/°C, ±50ppm/°C, ±100ppm/°C, ±200ppm/°C

DERATING CURVE

For resistors operated in ambient temperatures above 70°C, power rating must be derated in accordance with the curve below.

Rated Load (%)

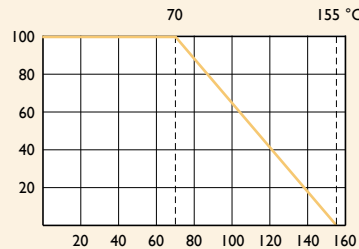

Ambient Temperature (°C)

DIMENSIONS

Unit: mm

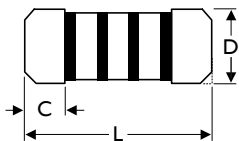

STYLE

DIMENSION

Normal	Miniature	L	D	C Min.
MMF-12	MMF25S / MMF204	3.50±0.2	1.40±0.15	0.5
MMF-25	MMF50S / MMF207	5.90±0.2	2.20±0.1	0.5
MMF-50	MMF1WS	8.50±0.2	3.20±0.2	0.5

Note:

ELECTRICAL CHARACTERISTICS

STYLE	MMF-12	MMF25S	MMF204	MMF-25	MMF50S	MMF207	MMF-50	MMFIWS
Power Rating at 70°C	1/6W	1/4W	0.4W	1/4W	1/2W	0.6W	1/2W	1W
Maximum Working Voltage	150V	200V		250V			350V	
Maximum Overload Voltage	300V	400V		500V			700V	
Voltage Proof	300V			500V			700V	
Resistance Range	1 Ω - 1M Ω & 0 Ω for E24 & E96 series value, 100 Ω - 100K Ω for E192 series value							
Operating Temp. Range	-55°C to +155°C							
Temperature Coefficient	±15ppm/°C, ±25ppm/°C, ±50ppm/°C, ±100ppm/°C, ±200ppm/°C							

Note: Special value is available on request

ENVIRONMENTAL CHARACTERISTICS

PERFORMANCE TEST	TEST METHOD	APPRAISE
Short Time Overload	IEC 60115-1 4.13 2.5 times RCWV for 5 Sec.	±0.5%+0.05 Ω
Voltage Proof	IEC 60115-1 4.7 in V-block for 60 Sec., test voltage by type	By type
Temperature Coefficient	IEC 60115-1 4.8 -55°C to +155°C	By type
Insulation Resistance	IEC 60115-1 4.6 in V-block for 60 Sec.	>10,000M Ω
Solderability	IEC 60115-1 4.17 235±5°C for 3±0.5 Sec.	95% Min. coverage
Solvent Resistance of Marking	IEC 60115-1 4.30 IPA for 5±0.5 Min. with ultrasonic	No deterioration of coatings and markings
Periodic-pulse Overload	IEC 60115-1 4.39 4 times RCWV 10,000 cycles (1 Sec. on, 25 Sec. off)	±1.0%+0.05 Ω
Damp Heat Steady State	IEC 60115-1 4.24 40±2°C, 90-95% RH for 56 days, loaded with 0.1 times RCWV	±2.0%+0.1 Ω
Endurance at 70°C	IEC 60115-1 4.25 70±2°C at RCWV for 1,000 Hr. (1.5 Hr. on, 0.5 Hr. off)	±2.0%+0.1 Ω
Temperature Cycling	IEC 60115-1 4.19 -55°C ⇌ Room Temp. ⇌ +155°C ⇌ Room Temp. (5 cycles)	±0.75%+0.05 Ω
Resistance to Soldering Heat	IEC 60115-1 4.18 260±3°C for 10±1 Sec., immersed to a point 3±0.5mm from the body	±0.5%+0.05 Ω

Note: Rated Continuous Working Voltage (RCWV) = $\sqrt{\text{Power Rating} \times \text{Resistance Value}}$

Melf Metal Film Resistors

High Power Type

Ultra Miniature Style [MMP Series]



INTRODUCTION

The MMP Series Melf Metal Film High Power Resistors are manufactured using a vacuum sputtering system to deposit multiple layers of mixed metal alloys and passivative materials onto a carefully treated high grade ceramic substrate. After a helical groove has been cut in the resistive layer, SMD enabled structure and high power in small packages. The resistors are coated with layers of lacquer.

FEATURES

Power Rating	1W, 2W
Resistance Tolerance	±1%, ±2%, ±5%
T.C.R.	±50ppm/°C, ±100ppm/°C, ±200ppm/°C

DERATING CURVE

For resistors operated in ambient temperatures above 70°C, power rating must be derated in accordance with the curve below.

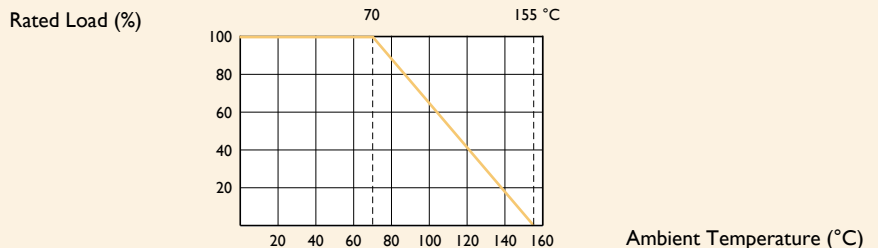

DIMENSIONS

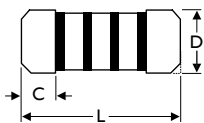

Unit: mm

STYLE	DIMENSION		
	L	D	C Min.
Ultra Miniature			
MMP100	5.9±0.2	2.2±0.1	0.5
MMP200	8.5±0.2	3.2±0.2	0.5

Note:

ELECTRICAL CHARACTERISTICS

STYLE	MMP100	MMP200
Power Rating at 70°C	1W	2W
Maximum Working Voltage	350V	
Maximum Overload Voltage	700V	
Voltage Proof	500V	
Resistance Range	1 Ω - 1M Ω & 0 Ω for E24 & E96 series value	
Operating Temp. Range	-55°C to +155°C	
Temperature Coefficient	±50ppm/°C, ±100ppm/°C, ±200ppm/°C	

Note: Special value is available on request

ENVIRONMENTAL CHARACTERISTICS

PERFORMANCE TEST	TEST METHOD	APPRAISE
Short Time Overload	IEC 60115-1 4.13 2.5 times RCWV for 5 Sec.	±0.5%+0.05 Ω
Voltage Proof	IEC 60115-1 4.7 in V-block for 60 Sec., test voltage by type	By type
Temperature Coefficient	IEC 60115-1 4.8 -55°C to +155°C	By type
Insulation Resistance	IEC 60115-1 4.6 in V-block for 60 Sec.	>10,000M Ω
Solderability	IEC 60115-1 4.17 235±5°C for 3±0.5 Sec.	95% Min. coverage
Solvent Resistance of Marking	IEC 60115-1 4.30 IPA for 5±0.5 Min. with ultrasonic	No deterioration of coatings and markings
Periodic-pulse Overload	IEC 60115-1 4.39 4 times RCWV 10,000 cycles (1 Sec. on, 25 Sec. off)	±1.0%+0.05 Ω
Damp Heat Steady State	IEC 60115-1 4.24 40±2°C, 90-95% RH for 56 days, loaded with 0.1 times RCWV	±2.0%+0.1 Ω
Endurance at 70°C	IEC 60115-1 4.25 70±2°C at RCWV for 1,000 Hr. (1.5 Hr. on, 0.5 Hr. off)	±2.0%+0.1 Ω
Temperature Cycling	IEC 60115-1 4.19 -55°C ⇄ Room Temp. ⇄ +155°C ⇄ Room Temp. (5 cycles)	±0.75%+0.05 Ω
Resistance to Soldering Heat	IEC 60115-1 4.18 260±3°C for 10±1 Sec., immersed to a point 3±0.5mm from the body	±0.5%+0.05 Ω

Note: Rated Continuous Working Voltage (RCWV) = $\sqrt{\text{Power Rating} \times \text{Resistance Value}}$

Carbon Film Resistors

General Type

Normal & Miniature Style [CFR Series]



INTRODUCTION

The CFR Series Carbon Film Resistors are manufactured by coating a homogeneous film of pure carbon on high grade ceramic rods. After a helical groove has been cut in the resistive layer, tinned connecting leads of electrolytic copper are welded to the end-caps. The resistors are coated with layers of tan color lacquer.

FEATURES

Power Rating	1/6W, 1/4W, 1/2W, 1W, 2W, 3W
Resistance Tolerance	±2%, ±5%
T.C.R.	see Table I

DERATING CURVE

For resistors operated in ambient temperatures above 70°C, power rating must be derated in accordance with the curve below.

Rated Load (%)

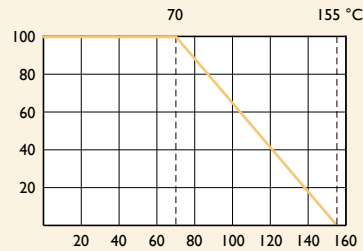

Ambient Temperature (°C)

TABLE I TEMPERATURE COEFFICIENT

STYLE	MAX. VALUE OF TEMP. COEFFICIENT PPM/°C		
	under 100K Ω	100K Ω - 1M Ω	1M Ω - 10M Ω
CFR100, CFR200, CFR2WS, CFR3WS	±350	-500	-1,500
CFR-12, CFR-25, CFR-50, CFR25S, CFR50S, CFR1WS	+350 / -500	-700	-1,500

DIMENSIONS

Unit: mm

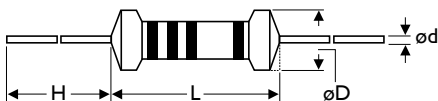

STYLE		DIMENSION			
Normal	Miniature	L	øD	H	ød
CFR-12	CFR25S	3.4±0.3	1.9±0.2	28±2.0	0.45±0.05
CFR-25	CFR50S	6.3±0.5	2.4±0.2	28±2.0	0.55±0.05
CFR-50	CFR1WS	9.0±0.5	3.3±0.3	26±2.0	0.55±0.05
CFR100	CFR2WS	11.5±1.0	4.5±0.5	35±2.0	0.8±0.05
CFR200	CFR3WS	15.5±1.0	5.0±0.5	33±2.0	0.8±0.05

Note:

ELECTRICAL CHARACTERISTICS

STYLE	CFR-12	CFR25S	CFR-25	CFR50S	CFR-50	CFRIWS	CFRI00	CFR2WS	CFR200	CFR3WS
Power Rating at 70°C	1/6W	1/4W		1/2W		1W		2W		3W
Maximum Working Voltage	150V	200V	250V	300V	350V	400V	500V			
Maximum Overload Voltage	300V	400V	500V	600V	700V	800V	1,000V			
Voltage Proof	300V	400V	500V			700V	1,000V			
Resistance Range	1 Ω - 10M Ω & 0 Ω for E24 series value									
Operating Temp. Range	-55°C to +155°C									
Temperature Coefficient	see Table I									

Note: Special value is available on request

ENVIRONMENTAL CHARACTERISTICS

PERFORMANCE TEST	TEST METHOD		APPRAISE
Short Time Overload	IEC 60115-1 4.13	2.5 times RCWV for 5 Sec.	±0.75%+0.05 Ω
Voltage Proof	IEC 60115-1 4.7	in V-block for 60 Sec., test voltage by type	By type
Temperature Coefficient	IEC 60115-1 4.8	-55°C to +155°C	By type
Insulation Resistance	IEC 60115-1 4.6	in V-block for 60 Sec.	>1,000M Ω
Solderability	IEC 60115-1 4.17	235±5°C for 3±0.5 Sec.	95% Min. coverage
Solvent Resistance of Marking	IEC 60115-1 4.30	IPA for 5±0.5 Min. with ultrasonic	No deterioration of coatings and markings
Robustness of Terminations	IEC 60115-1 4.16	Direct load for 10 Sec. in the direction of the terminal leads	≥2.5kg (24.5N)
Periodic-pulse Overload	IEC 60115-1 4.39	4 times RCWV 10,000 cycles (1 Sec. on, 25 Sec. off)	±1.0%+0.05 Ω
Damp Heat Steady State	IEC 60115-1 4.24	40±2°C, 90-95% RH for 56 days, loaded with 0.1 times RCWV	±3.0%+0.05 Ω
Endurance at 70°C	IEC 60115-1 4.25	70±2°C at RCWV for 1,000 Hr. (1.5 Hr. on, 0.5 Hr. off)	±3.0%+0.05 Ω
Temperature Cycling	IEC 60115-1 4.19	-55°C ⇌ Room Temp. ⇌ +155°C ⇌ Room Temp. (5 cycles)	±1.0%+0.05 Ω
Resistance to Soldering Heat	IEC 60115-1 4.18	260±3°C for 10±1 Sec., immersed to a point 3±0.5mm from the body	±1.0%+0.05 Ω

Note: Rated Continuous Working Voltage (RCWV) = $\sqrt{\text{Power Rating} \times \text{Resistance Value}}$

Carbon Film Resistors

Professional Type

Miniature Style [CF0 Series]

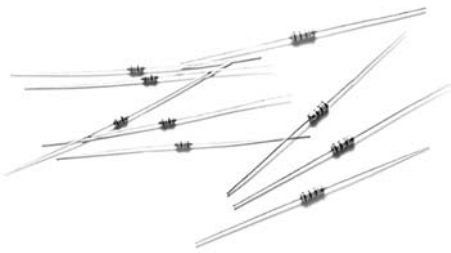

INTRODUCTION

The CF0 Series Carbon Film Professional Resistors are manufactured by coating a homogeneous film of pure carbon on high grade ceramic rods. After a helical groove has been cut in the resistive layer, tinned connecting leads of electrolytic copper are welded to the end-caps. The resistors are coated with layers of tan color lacquer.

FEATURES

Power Rating	0.4W, 0.6W
Resistance Tolerance	±2%, ±5%
T.C.R.	see Table I

DERATING CURVE

For resistors operated in ambient temperatures above 70°C, power rating must be derated in accordance with the curve below.

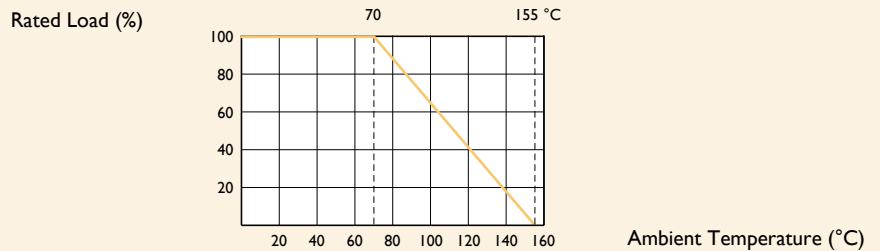
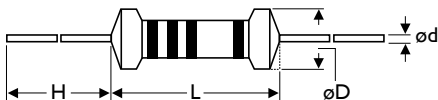

TABLE I TEMPERATURE COEFFICIENT

STYLE	MAX. VALUE OF TEMP. COEFFICIENT PPM/°C		
	under 100K Ω	100K Ω - 1M Ω	1M Ω - 10M Ω
CF0204, CF0207	+350 / -500	-700	-1,500

DIMENSIONS

Unit: mm



STYLE	DIMENSION			
	L	øD	H	ød
Miniature				
CF0204	3.4±0.3	1.9±0.2	28±2.0	0.45±0.05
CF0207	6.3±0.5	2.4±0.2	28±2.0	0.55±0.05

Note:

ELECTRICAL CHARACTERISTICS

STYLE	CF0204	CF0207
Power Rating at 70°C	0.4W	0.6W
Maximum Working Voltage	200V	300V
Maximum Overload Voltage	400V	600V
Voltage Proof	300V	500V
Resistance Range	1 Ω - 10M Ω & 0 Ω for E24 series value	
Operating Temp. Range	-55°C to +155°C	
Temperature Coefficient	see Table I	

Note: Special value is available on request

ENVIRONMENTAL CHARACTERISTICS

PERFORMANCE TEST	TEST METHOD	APPRAISE
Short Time Overload	IEC 60115-1 4.13 2.5 times RCWV for 5 Sec.	±0.75%+0.05 Ω
Voltage Proof	IEC 60115-1 4.7 in V-block for 60 Sec., test voltage by type	By type
Temperature Coefficient	IEC 60115-1 4.8 -55°C to +155°C	By type
Insulation Resistance	IEC 60115-1 4.6 in V-block for 60 Sec.	>1,000M Ω
Solderability	IEC 60115-1 4.17 235±5°C for 3±0.5 Sec.	95% Min. coverage
Solvent Resistance of Marking	IEC 60115-1 4.30 IPA for 5±0.5 Min. with ultrasonic	No deterioration of coatings and markings
Robustness of Terminations	IEC 60115-1 4.16 Direct load for 10 Sec. in the direction of the terminal leads	≥2.5kg (24.5N)
Periodic-pulse Overload	IEC 60115-1 4.39 4 times RCWV 10,000 cycles (1 Sec. on, 25 Sec. off)	±1.0%+0.05 Ω
Damp Heat Steady State	IEC 60115-1 4.24 40±2°C, 90-95% RH for 56 days, loaded with 0.1 times RCWV	±3.0%+0.05 Ω
Endurance at 70°C	IEC 60115-1 4.25 70±2°C at RCWV for 1,000 Hr. (1.5 Hr. on, 0.5 Hr. off)	±3.0%+0.05 Ω
Temperature Cycling	IEC 60115-1 4.19 -55°C ⇌ Room Temp. ⇌ +155°C ⇌ Room Temp. (5 cycles)	±1.0%+0.05 Ω
Resistance to Soldering Heat	IEC 60115-1 4.18 260±3°C for 10±1 Sec., immersed to a point 3±0.5mm from the body	±1.0%+0.05 Ω

Note: Rated Continuous Working Voltage (RCWV) = $\sqrt{\text{Power Rating} \times \text{Resistance Value}}$

Carbon Film Resistors

Flame-Proof Type

Normal & Miniature Style [FCR Series]

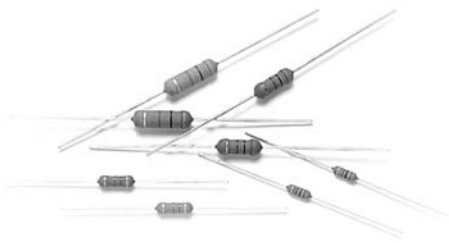

INTRODUCTION

The FCR Series Carbon Film Flame-Proof Resistors are manufactured by coating a homogeneous film of pure carbon on high grade ceramic rods. After a helical groove has been cut in the resistive layer, tinned connecting leads of electrolytic copper are welded to the end-caps. The resistors are coated with layers of gray color lacquer.

FEATURES

Power Rating	1/4W, 1/2W, 1W, 2W, 3W
Resistance Tolerance	±2%, ±5%
T.C.R.	see Table 1
Flameproof Multi-layer Coating Meets	UL-94V-0
Flameproof Feature Meets Overload Test	UL-1412

DERATING CURVE

For resistors operated in ambient temperatures above 70°C, power rating must be derated in accordance with the curve below.

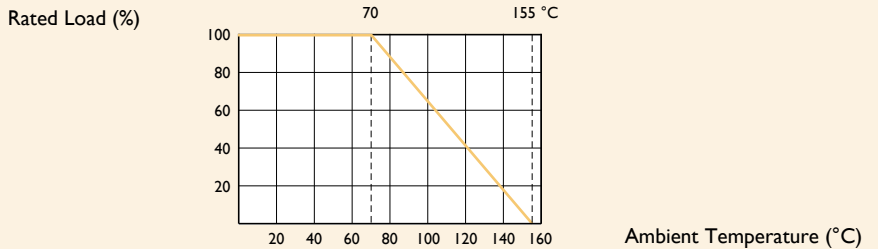
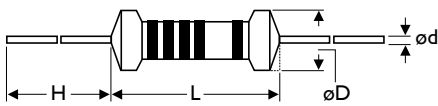

TABLE I TEMPERATURE COEFFICIENT

STYLE	MAX. VALUE OF TEMP. COEFFICIENT PPM/°C		
	under 100K Ω	100K Ω - 1M Ω	1M Ω - 10M Ω
FCR100, FCR200, FCR2WS, FCR3WS	±350	-500	-1,500
FCR-25, FCR-50, FCR50S, FCR1WS	+350 / -500	-700	-1,500

DIMENSIONS



5th color code: black

Unit: mm

STYLE		DIMENSION			
Normal	Miniature	L	øD	H	ød
FCR-25	FCR50S	6.3±0.5	2.4±0.2	28±2.0	0.55±0.05
FCR-50	FCR1WS	9.0±0.5	3.3±0.3	26±2.0	0.55±0.05
FCR100	FCR2WS	11.5±1.0	4.5±0.5	35±2.0	0.8±0.05
FCR200	FCR3WS	15.5±1.0	5.0±0.5	33±2.0	0.8±0.05

Note:

ELECTRICAL CHARACTERISTICS

STYLE	FCR-25	FCR50S	FCR-50	FCRIWS	FCRI00	FCR2WS	FCR200	FCR3WS
Power Rating at 70°C	1/4W	1/2W		1W		2W		3W
Maximum Working Voltage	250V	300V	350V	400V	500V			
Maximum Overload Voltage	500V	600V	700V	800V	1,000V			
Voltage Proof	400V		500V	600V	750V			
Resistance Range	1 Ω - 10M Ω & 0 Ω for E24 series value							
Operating Temp. Range	-55°C to +155°C							
Temperature Coefficient	see Table I							

Note: Special value is available on request

ENVIRONMENTAL CHARACTERISTICS

PERFORMANCE TEST	TEST METHOD	APPRAISE
Short Time Overload	IEC 60115-1 4.13 2.5 times RCWV for 5 Sec.	±0.75%+0.05 Ω
Voltage Proof	IEC 60115-1 4.7 in V-block for 60 Sec., test voltage by type	By type
Temperature Coefficient	IEC 60115-1 4.8 -55°C to +155°C	By type
Insulation Resistance	IEC 60115-1 4.6 in V-block for 60 Sec.	>1,000M Ω
Solderability	IEC 60115-1 4.17 235±5°C for 3±0.5 Sec.	95% Min. coverage
Solvent Resistance of Marking	IEC 60115-1 4.30 IPA for 5±0.5 Min. with ultrasonic	No deterioration of coatings and markings
Robustness of Terminations	IEC 60115-1 4.16 Direct load for 10 Sec. in the direction of the terminal leads	≥2.5kg (24.5N)
Periodic-pulse Overload	IEC 60115-1 4.39 4 times RCWV 10,000 cycles (1 Sec. on, 25 Sec. off)	±1.0%+0.05 Ω
Damp Heat Steady State	IEC 60115-1 4.24 40±2°C, 90-95% RH for 56 days, loaded with 0.1 times RCWV	±3.0%+0.05 Ω
Endurance at 70°C	IEC 60115-1 4.25 70±2°C at RCWV for 1,000 Hr. (1.5 Hr. on, 0.5 Hr. off)	±3.0%+0.05 Ω
Temperature Cycling	IEC 60115-1 4.19 -55°C ⇌ Room Temp. ⇌ +155°C ⇌ Room Temp. (5 cycles)	±1.0%+0.05 Ω
Resistance to Soldering Heat	IEC 60115-1 4.18 260±3°C for 10±1 Sec., immersed to a point 3±0.5mm from the body	±1.0%+0.05 Ω
Accidental Overload Test	IEC 60115-1 4.26 4 times RCWV for 1 Min.	No evidence of flaming or arcing

Note: Rated Continuous Working Voltage (RCWV) = $\sqrt{\text{Power Rating} \times \text{Resistance Value}}$

Carbon Film Resistors

Professional & Flame-Proof Type

Miniature Style [FC0 Series]

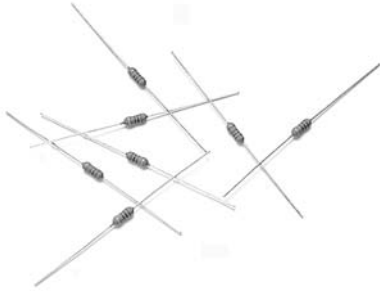

INTRODUCTION

The FC0 Series Carbon Film Professional & Flame-Proof Resistors are manufactured by coating a homogeneous film of pure carbon on high grade ceramic rods. After a helical groove has been cut in the resistive layer; tinned connecting leads of electrolytic copper are welded to the end-caps. The resistors are coated with layers of green color lacquer.

FEATURES

Power Rating	0.4W, 0.6W
Resistance Tolerance	±2%, ±5%
T.C.R.	see Table I
Flameproof Multi-layer Coating Meets	UL-94V-0
Flameproof Feature Meets Overload Test	UL-1412

DERATING CURVE

For resistors operated in ambient temperatures above 70°C, power rating must be derated in accordance with the curve below.

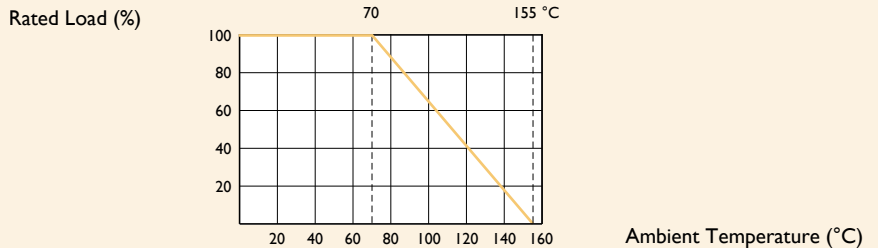
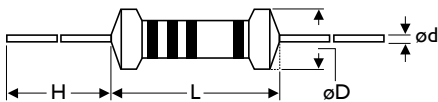

TABLE I TEMPERATURE COEFFICIENT

STYLE	MAX. VALUE OF TEMP. COEFFICIENT PPM/°C		
	under 100K Ω	100K Ω - 1M Ω	1M Ω - 10M Ω
FC0204, FC0207	+300 / -500	-700	-1,500

DIMENSIONS



Unit: mm

STYLE	DIMENSION			
	L	øD	H	ød
Miniature				
FC0204	3.4±0.3	1.9±0.2	28±2.0	0.45±0.05
FC0207	6.3±0.5	2.4±0.2	28±2.0	0.55±0.05

Note:

ELECTRICAL CHARACTERISTICS

STYLE	FC0204	FC0207
Power Rating at 70°C	0.4W	0.6W
Maximum Working Voltage	200V	300V
Maximum Overload Voltage	400V	600V
Voltage Proof	300V	500V
Resistance Range	1 Ω - 10M Ω & 0 Ω for E24 series value	
Operating Temp. Range	-55°C to +155°C	
Temperature Coefficient	see Table I	

Note: Special value is available on request

ENVIRONMENTAL CHARACTERISTICS

PERFORMANCE TEST	TEST METHOD	APPRAISE
Short Time Overload	IEC 60115-1 4.13 2.5 times RCWV for 5 Sec.	±0.75%+0.05 Ω
Voltage Proof	IEC 60115-1 4.7 in V-block for 60 Sec., test voltage by type	By type
Temperature Coefficient	IEC 60115-1 4.8 -55°C to +155°C	By type
Insulation Resistance	IEC 60115-1 4.6 in V-block for 60 Sec.	>1,000M Ω
Solderability	IEC 60115-1 4.17 235±5°C for 3±0.5 Sec.	95% Min. coverage
Solvent Resistance of Marking	IEC 60115-1 4.30 IPA for 5±0.5 Min. with ultrasonic	No deterioration of coatings and markings
Robustness of Terminations	IEC 60115-1 4.16 Direct load for 10 Sec. in the direction of the terminal leads	≥2.5kg (24.5N)
Periodic-pulse Overload	IEC 60115-1 4.39 4 times RCWV 10,000 cycles (1 Sec. on, 25 Sec. off)	±1.0%+0.05 Ω
Damp Heat Steady State	IEC 60115-1 4.24 40±2°C, 90-95% RH for 56 days, loaded with 0.1 times RCWV	±3.0%+0.05 Ω
Endurance at 70°C	IEC 60115-1 4.25 70±2°C at RCWV for 1,000 Hr. (1.5 Hr. on, 0.5 Hr. off)	±3.0%+0.05 Ω
Temperature Cycling	IEC 60115-1 4.19 -55°C ⇌ Room Temp. ⇌ +155°C ⇌ Room Temp. (5 cycles)	±1.0%+0.05 Ω
Resistance to Soldering Heat	IEC 60115-1 4.18 260±3°C for 10±1 Sec., immersed to a point 3±0.5mm from the body	±1.0%+0.05 Ω
Accidental Overload Test	IEC 60115-1 4.26 4 times RCWV for 1 Min.	No evidence of flaming or arcing

Note: Rated Continuous Working Voltage (RCWV) = $\sqrt{\text{Power Rating} \times \text{Resistance Value}}$

Carbon Film Resistors

Non-Inductive & Flame-Proof Type

Normal & Miniature Style [NCR Series]



INTRODUCTION

The NCR Series Carbon Film Non-Inductive & Flame-Proof Resistors are manufactured by coating a homogeneous film of pure carbon on high grade ceramic rods. Tinned connecting leads of electrolytic copper are welded to the end-caps. The inductance is $< 1 \mu\text{H}$.

The resistors are coated with layers of gray color lacquer for normal size & pink color lacquer for miniature size.

FEATURES

Power Rating	1/4W, 1/2W, 1W, 2W, 3W
Resistance Tolerance	$\pm 5\%$, $\pm 10\%$
T.C.R.	see Table I
Flameproof Multi-layer Coating Meets	UL-94V-0
Flameproof Feature Meets Overload Test	UL-1412

DERATING CURVE

For resistors operated in ambient temperatures above 70°C , power rating must be derated in accordance with the curve below.

Rated Load (%)

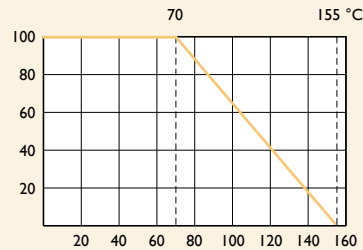

Ambient Temperature ($^\circ\text{C}$)

TABLE I TEMPERATURE COEFFICIENT

VALUE RANGE	MAX. VALUE OF TEMP. COEFFICIENT PPM/ $^\circ\text{C}$
Under $5\text{K } \Omega$	-500
$5\text{K} - 10\text{K } \Omega$	-800

DIMENSIONS

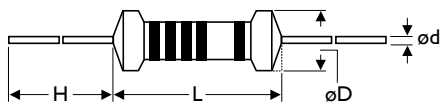

5th color code: green

Unit: mm

STYLE		DIMENSION			
Normal	Miniature	L	ϕD	H	ϕd
NCR-25	NCR50S	6.3 ± 0.5	2.4 ± 0.2	28 ± 2.0	0.55 ± 0.05
NCR-50	NCR1WS	9.0 ± 0.5	3.3 ± 0.3	26 ± 2.0	0.55 ± 0.05
NCR100	NCR2WS	11.5 ± 1.0	4.5 ± 0.5	35 ± 2.0	0.8 ± 0.05
NCR200	NCR3WS	15.5 ± 1.0	5.0 ± 0.5	33 ± 2.0	0.8 ± 0.05

Note:

ELECTRICAL CHARACTERISTICS

STYLE	NCR-25	NCR50S	NCR-50	NCRIWS	NCR100	NCR2WS	NCR200	NCR3WS
Power Rating at 70°C	1/4W	1/2W		1W		2W		3W
Maximum Working Voltage	250V	300V	350V	400V	500V			
Maximum Overload Voltage	500V	600V	700V	800V	1,000V			
Voltage Proof	500V		700V		1,000V			
Resistance Range	2.2 Ω - 10K Ω for E24 series value							
Operating Temp. Range	-55°C to +155°C							
Temperature Coefficient	see Table I							

Note: Special value is available on request

ENVIRONMENTAL CHARACTERISTICS

PERFORMANCE TEST	TEST METHOD	APPRAISE
Short Time Overload	IEC 60115-1 4.13 2.5 times RCWV for 5 Sec.	±0.75%+0.05 Ω for normal style ±2.0%+0.05 Ω for miniature style
Voltage Proof	IEC 60115-1 4.7 in V-block for 60 Sec., test voltage by type	By type
Temperature Coefficient	IEC 60115-1 4.8 -55°C to +155°C	By type
Insulation Resistance	IEC 60115-1 4.6 in V-block for 60 Sec.	>1,000M Ω
Solderability	IEC 60115-1 4.17 235±5°C for 3±0.5 Sec.	95% Min. coverage
Solvent Resistance of Marking	IEC 60115-1 4.30 IPA for 5±0.5 Min. with ultrasonic	No deterioration of coatings and markings
Robustness of Terminations	IEC 60115-1 4.16 Direct load for 10 Sec. in the direction of the terminal leads	≥2.5kg (24.5N)
Periodic-pulse Overload	IEC 60115-1 4.39 4 times RCWV 10,000 cycles (1 Sec. on, 25 Sec. off)	±1.0%+0.05 Ω
Damp Heat Steady State	IEC 60115-1 4.24 40±2°C, 90-95% RH for 56 days, loaded with 0.1 times RCWV	±3.0%+0.05 Ω
Endurance at 70°C	IEC 60115-1 4.25 70±2°C at RCWV for 1,000 Hr. (1.5 Hr. on, 0.5 Hr. off)	±3.0%+0.05 Ω
Temperature Cycling	IEC 60115-1 4.19 -55°C ⇌ Room Temp. ⇌ +155°C ⇌ Room Temp. (5 cycles)	±1.0%+0.05 Ω
Resistance to Soldering Heat	IEC 60115-1 4.18 260±3°C for 10±1 Sec., immersed to a point 3±0.5mm from the body	±1.0%+0.05 Ω
Accidental Overload Test	IEC 60115-1 4.26 4 times RCWV for 1 Min.	No evidence of flaming or arcing

Note: Rated Continuous Working Voltage (RCWV) = $\sqrt{\text{Power Rating} \times \text{Resistance Value}}$

Carbon Film Resistors

Biased Humidity Type

Normal & Miniature Style [CFN Series]

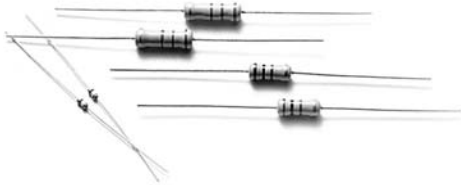

INTRODUCTION

The CFN Series Carbon Film Biased Humidity Resistors are manufactured by coating a homogeneous film of pure carbon on high grade ceramic rods. After a helical groove has been cut in the resistive layer, tinned connecting leads of electrolytic copper are welded to the end-caps. The resistors are coated with a specialized tan lacquer. Its processes and controls ensure the product is impervious to moisture.

FEATURES

Power Rating	1/6W, 1/4W, 1/2W, 1W, 2W, 3W
Resistance Tolerance	±2%, ±5%
T.C.R.	see Table I

DERATING CURVE

For resistors operated in ambient temperatures above 70°C, power rating must be derated in accordance with the curve below.

Rated Load (%)

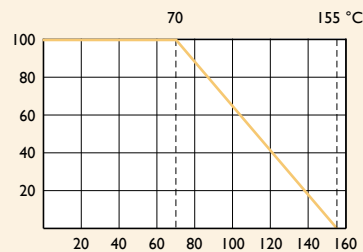

Ambient Temperature (°C)

TABLE I TEMPERATURE COEFFICIENT

STYLE	MAX. VALUE OF TEMP. COEFFICIENT PPM/°C		
	under 100K Ω	100K Ω - 1M Ω	1M Ω - 10M Ω
CFN100,CFN200,CFN2WS,CFN3WS	±350	-500	-1,500
CFN-12, CFN-25, CFN-50, CFN25S, CFN50S, CFN1WS	+350 / -500	-700	-1,500

Unit: mm

DIMENSIONS

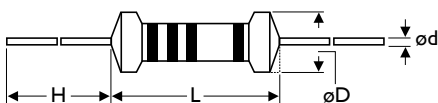

STYLE

DIMENSION

Normal	Miniature	L	øD	H	ød
CFN-12	CFN25S	3.4±0.3	1.9±0.2	28±2.0	0.45±0.05
CFN-25	CFN50S	6.3±0.5	2.4±0.2	28±2.0	0.55±0.05
CFN-50	CFN1WS	9.0±0.5	3.3±0.3	26±2.0	0.55±0.05
CFN100	CFN2WS	11.5±1.0	4.5±0.5	35±2.0	0.8±0.05
CFN200	CFN3WS	15.5±1.0	5.0±0.5	33±2.0	0.8±0.05

Note:

ELECTRICAL CHARACTERISTICS

STYLE	CFN-12	CFN25S	CFN-25	CFN50S	CFN-50	CFNIWS	CFN100	CFN2WS	CFN200	CFN3WS
Power Rating at 70°C	1/6W	1/4W		1/2W		1W		2W		3W
Maximum Working Voltage	150V	200V	250V	300V	350V	400V	500V			
Maximum Overload Voltage	300V	400V	500V	600V	700V	800V	1,000V			
Voltage Proof	300V	400V	500V			700V	1,000V			
Resistance Range	1 Ω - 10M Ω & 0 Ω for E24 series value									
Operating Temp. Range	-55°C to +155°C									
Temperature Coefficient	see Table I									

Note: Special value is available on request

ENVIRONMENTAL CHARACTERISTICS

PERFORMANCE TEST	TEST METHOD		APPRAISE
Short Time Overload	IEC 60115-1 4.13	2.5 times RCWV for 5 Sec.	±0.75%+0.05 Ω
Voltage Proof	IEC 60115-1 4.7	in V-block for 60 Sec., test voltage by type	No breakdown or flashover
Temperature Coefficient	IEC 60115-1 4.8	-55°C to +155°C	By type
Insulation Resistance	IEC 60115-1 4.6	in V-block for 60 Sec.	>1,000M
Solderability	IEC 60115-1 4.17	235±5°C for 3±0.5 Sec.	95% Min. coverage
Solvent Resistance of Marking	IEC 60115-1 4.30	IPA for 5±0.5 Min. with ultrasonic	No deterioration of coatings and markings
Robustness of Terminations	IEC 60115-1 4.16	Direct load for 10 Sec. in the direction of the terminal leads	≥2.5kg (24.5N)
Periodic-pulse Overload	IEC 60115-1 4.39	4 times RCWV 10,000 cycles (1 Sec. on, 25 Sec. off)	±1.0%+0.05 Ω
Damp Heat Steady State	IEC 60115-1 4.24	40±2°C, 90-95% RH for 56 days, loaded with 0.1 times RCWV	±3%+0.05 Ω
Endurance at 70°C	IEC 60115-1 4.25	70±2°C at RCWV for 1,000 Hr. (1.5 Hr. on, 0.5 Hr. off)	±3%+0.05 Ω
Temperature Cycling	IEC 60115-1 4.19	-55°C ⇌ Room Temp. ⇌ +155°C ⇌ Room Temp. (5 cycles)	±1%+0.05 Ω
Resistance to Soldering Heat	IEC 60115-1 4.18	260±3°C for 10±1 Sec., immersed to a point 3±0.5mm from the body	±1%+0.05 Ω

Note: Rated Continuous Working Voltage (RCWV) = $\sqrt{\text{Power Rating} \times \text{Resistance Value}}$

Melf Carbon Film Resistors

General Type

Normal & Miniature Style [MCF Series]



INTRODUCTION

The MCF Series Melf Carbon Film Resistors are manufactured by coating a homogeneous film of pure carbon on high grade ceramic rods. After a helical groove has been cut in the resistive layer, tinned connecting leads of electrolytic copper are welded to the end-caps. SMD enabled structure. The resistors are coated with layers of lacquer.

FEATURES

Power Rating	1/6W, 1/4W, 0.4W, 1/2W, 0.6W, 1W
Resistance Tolerance	±2%, ±5%
T.C.R.	see Table I

DERATING CURVE

For resistors operated in ambient temperatures above 70°C, power rating must be derated in accordance with the curve below.

Rated Load (%)

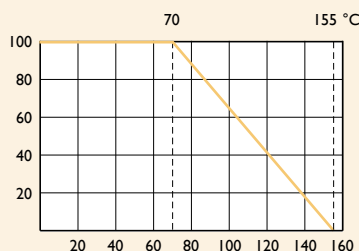

Ambient Temperature (°C)

TABLE I TEMPERATURE COEFFICIENT

STYLE	MAX. VALUE OF TEMP. COEFFICIENT PPM/°C			
	MCF-12, MCF25S, MCF204	under 1K Ω	1K1 Ω -47K Ω	51K Ω -470K Ω
	0 to -350	0 to -600	0 to -1,000	0 to -1,500
MCF-25, MCF50S, MCF207, MCF-50, MCF1WS	under 10K Ω	11K Ω -150K Ω	160K Ω -2M2 Ω	
	0 to -350	0 to -600	0 to -1,000	

DIMENSIONS

Unit: mm

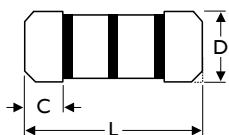

STYLE	DIMENSION	DIMENSION		
		Normal	Miniature	L
MCF-12	MCF25S / MCF204	3.50±0.2	1.40±0.15	0.5
MCF-25	MCF50S / MCF207	5.90±0.2	2.20±0.1	0.5
MCF-50	MCF1WS	8.50±0.2	3.20±0.2	0.5

Note:

ELECTRICAL CHARACTERISTICS

STYLE	MCF-12	MCF25S	MCF204	MCF-25	MCF50S	MCF207	MCF-50	MCFIWS
Power Rating at 70°C	1/6W	1/4W	0.4W	1/4W	1/2W	0.6W	1/2W	1W
Maximum Working Voltage	200V	250V		300V			350V	
Maximum Overload Voltage	400V	500V		600V			700V	
Voltage Proof	200V			500V			700V	
Resistance Range	10 Ω - 1M Ω & 0 Ω for E24 series value							
Operating Temp. Range	-55°C to +155°C							
Temperature Coefficient	see Table I							

Note: Special value is available on request

ENVIRONMENTAL CHARACTERISTICS

PERFORMANCE TEST	TEST METHOD	APPRAISE
Short Time Overload	IEC 60115-1 4.13 2.5 times RCWV for 5 Sec.	±1.0%+0.05 Ω
Voltage Proof	IEC 60115-1 4.7 in V-block for 60 Sec., test voltage by type	By type
Temperature Coefficient	IEC 60115-1 4.8 -55°C to +155°C	By type
Insulation Resistance	IEC 60115-1 4.6 in V-block for 60 Sec.	>10,000M Ω
Solderability	IEC 60115-1 4.17 235±5°C for 3±0.5 Sec.	95% Min. coverage
Solvent Resistance of Marking	IEC 60115-1 4.30 IPA for 5±0.5 Min. with ultrasonic	No deterioration of coatings and markings
Periodic-pulse Overload	IEC 60115-1 4.39 4 times RCWV 10,000 cycles (1 Sec. on, 25 Sec. off)	±1.0%+0.05 Ω
Damp Heat Steady State	IEC 60115-1 4.24 40±2°C, 90-95% RH for 56 days, loaded with 0.1 times RCWV	±5.0%+0.1 Ω
Endurance at 70°C	IEC 60115-1 4.25 70±2°C at RCWV for 1,000 Hr. (1.5 Hr. on, 0.5 Hr. off)	±3.0%+0.1 Ω
Temperature Cycling	IEC 60115-1 4.19 -55°C ⇄ Room Temp. ⇄ +155°C ⇄ Room Temp. (5 cycles)	±0.75%+0.05 Ω
Resistance to Soldering Heat	IEC 60115-1 4.18 260±3°C for 10±1 Sec., immersed to a point 3±0.5mm from the body	±1.0%+0.05 Ω

Note: Rated Continuous Working Voltage (RCWV) = $\sqrt{\text{Power Rating} \times \text{Resistance Value}}$

Melf Carbon Film Resistors

High Power Type

Ultra Miniature Style [MCP Series]



INTRODUCTION

The MCP Series Melf Carbon Film High Power Resistors are manufactured by coating a homogeneous film of pure carbon on high grade ceramic rods. After a helical groove has been cut in the resistive layer, tinned connecting leads of electrolytic copper are welded to the end-caps. SMD enabled structure and high power in small packages. The resistors are coated with layers of lacquer.

FEATURES

Power Rating	1W, 2W
Resistance Tolerance	±2%, ±5%
T.C.R.	see Table I

DERATING CURVE

For resistors operated in ambient temperatures above 70°C, power rating must be derated in accordance with the curve below.

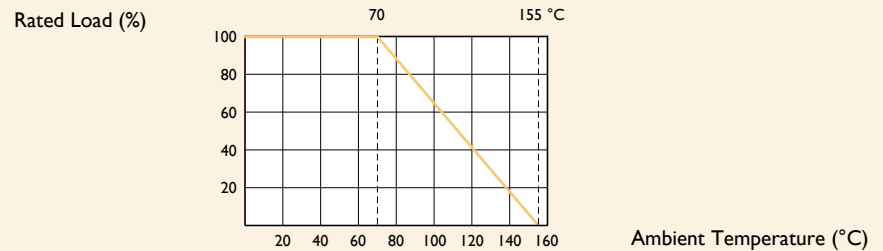
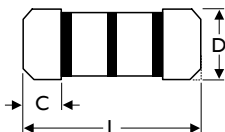

TABLE I TEMPERATURE COEFFICIENT

STYLE	MAX. VALUE OF TEMP. COEFFICIENT PPM/°C		
	under 10K Ω	11K Ω -150K Ω	160K Ω -2M2 Ω
MCP100, MCP200	0 to -350	0 to -600	0 to -1,000

DIMENSIONS

Unit: mm



STYLE	DIMENSION		
	L	D	C Min.
Ultra Miniature			
MCP100	5.9±0.2	2.2±0.1	0.5
MCP200	8.5±0.2	3.2±0.2	0.5

Note:

ELECTRICAL CHARACTERISTICS

STYLE	MCP100	MCP200
Power Rating at 70°C	1W	2W
Maximum Working Voltage	350V	
Maximum Overload Voltage	700V	
Voltage Proof	500V	
Resistance Range	1 Ω - 1M Ω & 0 Ω for E24 & E96 series value	
Operating Temp. Range	-55°C to +155°C	
Temperature Coefficient	See Table I	

Note: Special value is available on request

ENVIRONMENTAL CHARACTERISTICS

PERFORMANCE TEST	TEST METHOD	APPRAISE
Short Time Overload	IEC 60115-1 4.13 2.5 times RCWV for 5 Sec.	±1.0%+0.05 Ω
Voltage Proof	IEC 60115-1 4.7 in V-block for 60 Sec., test voltage by type	By type
Temperature Coefficient	IEC 60115-1 4.8 -55°C to +155°C	By type
Insulation Resistance	IEC 60115-1 4.6 in V-block for 60 Sec.	>10,000M Ω
Solderability	IEC 60115-1 4.17 235±5°C for 3±0.5 Sec.	95% Min. coverage
Solvent Resistance of Marking	IEC 60115-1 4.30 IPA for 5±0.5 Min. with ultrasonic	No deterioration of coatings and markings
Periodic-pulse Overload	IEC 60115-1 4.39 4 times RCWV 10,000 cycles (1 Sec. on, 25 Sec. off)	±1.0%+0.05 Ω
Damp Heat Steady State	IEC 60115-1 4.24 40±2°C, 90-95% RH for 56 days, loaded with 0.1 times RCWV	±5.0%+0.1 Ω
Endurance at 70°C	IEC 60115-1 4.25 70±2°C at RCWV for 1,000 Hr. (1.5 Hr. on, 0.5 Hr. off)	±3.0%+0.1 Ω
Temperature Cycling	IEC 60115-1 4.19 -55°C ⇄ Room Temp. ⇄ +155°C ⇄ Room Temp. (5 cycles)	±0.75%+0.05 Ω
Resistance to Soldering Heat	IEC 60115-1 4.18 260±3°C for 10±1 Sec., immersed to a point 3±0.5mm from the body	±1.0%+0.05 Ω

Note: Rated Continuous Working Voltage (RCWV) = $\sqrt{\text{Power Rating} \times \text{Resistance Value}}$

Metal Glazed Film Resistors

High Voltage & High Ohmic Type

Normal & Miniature Style [HHV Series]

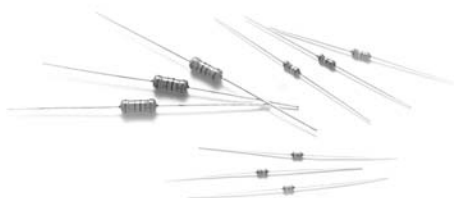

INTRODUCTION

The HHV Series High Voltage & High Ohmic Resistors are made of metal glaze film, with tinned connecting leads of electrolytic copper welded to the end of caps. The resistors are coated with layers of pink color lacquer.

FEATURES

Power Rating	1/4W, 1/2W, 1W, 2W, 3W
Resistance Tolerance	±1%, ±5%
T.C.R.	±200ppm/°C
Flameproof Multi-layer Coating Meets	UL-94V-0
Flameproof Feature Meets Overload Test	UL-1412

DERATING CURVE

For resistors operated in ambient temperatures above 70°C, power rating must be derated in accordance with the curve below.

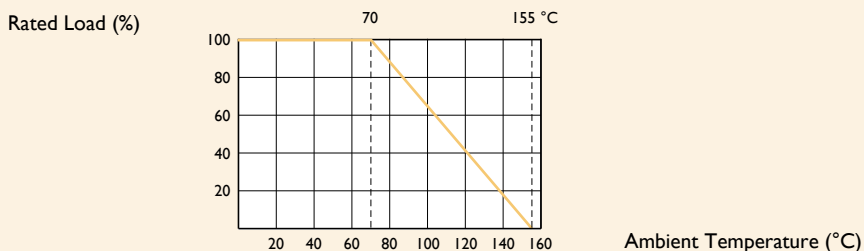

DIMENSIONS

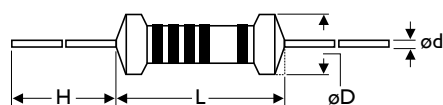

5th color code: yellow

Unit: mm

STYLE		DIMENSION			
Normal	Miniature	L	øD	H	ød
HHV-25	HHV50S	6.3±0.5	2.4±0.2	28±2.0	0.55±0.05
HHV-50	HHV1SS	9.0±0.5	3.3±0.3	26±2.0	0.55±0.05
HHV1WS	HHV2SS	11.5±1.0	4.5±0.5	35±2.0	0.8±0.05
HHV2WS	HHV3SS	15.5±1.0	5.0±0.5	33±2.0	0.8±0.05

Note:

ELECTRICAL CHARACTERISTICS

STYLE	HHV-25	HHV50S	HHV-50	HHVISS	HHVIWS	HHV2SS	HHV2WS	HHV3SS
Power Rating at 70°C	1/4W	1/2W		1W		2W		3W
Maximum Working Voltage (DC)	1,600V		3,500V		5,000V		7,000V	
Maximum Overload Voltage (DC)	3,000V		7,000V		10,000V		14,000V	
Voltage Proof	300V		500V		600V			
Resistance Range	100K Ω - 68M Ω for E24 & E96 series value							
Operating Temp. Range	-55°C to +155°C							
Temperature Coefficient	±200pm/°C							

Note: Special value is available on request

ENVIRONMENTAL CHARACTERISTICS

PERFORMANCE TEST	TEST METHOD		APPRAISE
Short Time Overload	IEC 60115-1 4.13	2.5 times RCWV for 5 Sec.	±2.0%+0.05 Ω
Voltage Proof	IEC 60115-1 4.7	in V-block for 60 Sec., test voltage by type	By type
Temperature Coefficient	IEC 60115-1 4.8	-55°C to +155°C	By type
Insulation Resistance	IEC 60115-1 4.6	in V-block for 60 Sec.	>10,000M Ω
Solderability	IEC 60115-1 4.17	235±5°C for 3±0.5 Sec.	95% Min. coverage
Solvent Resistance of Marking	IEC 60115-1 4.30	IPA for 5±0.5 Min. with ultrasonic	No deterioration of coatings and markings
Robustness of Terminations	IEC 60115-1 4.16	Direct load for 10 Sec. in the direction of the terminal leads	≥2.5kg (24.5N)
Periodic-pulse Overload	IEC 60115-1 4.39	4 times RCWV 10,000 cycles (1 Sec. on, 25 Sec. off)	±1.0%+0.05 Ω
Damp Heat Steady State	IEC 60115-1 4.24	40±2°C, 90-95% RH for 56 days, loaded with 0.1 times RCWV	±5.0%+0.05 Ω
Endurance at 70°C	IEC 60115-1 4.25	70±2°C at RCWV for 1,000 Hr. (1.5 Hr. on, 0.5 Hr. off)	±5.0%+0.05 Ω
Temperature Cycling	IEC 60115-1 4.19	-55°C ⇌ Room Temp. ⇌ +155°C ⇌ Room Temp. (5 cycles)	±1.0%+0.05 Ω
Resistance to Soldering Heat	IEC 60115-1 4.18	260±3°C for 10±1 Sec., immersed to a point 3±0.5mm from the body	±1.0%+0.05 Ω
Accidental Overload Test	IEC 60115-1 4.26	4 times RCWV for 1 Min.	No evidence of flaming or arcing

Note: Rated Continuous Working Voltage (RCWV) = $\sqrt{\text{Power Rating} \times \text{Resistance Value}}$

Pulse-Loading Resistors

Anti-Pulse Type

Normal & Miniature Style [APR Series]

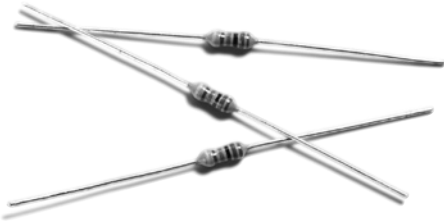

INTRODUCTION

The APR Series Pulse-Loading Resistors have excellent capability in withstanding pulse; tinned connecting leads of electrolytic copper are welded to the end-caps. The resistors are coated with layers of gray color lacquer. The 5th color band is yellow to represent APR series.

FEATURES

Power Rating	1/4W, 1/2W, 1W, 2W, 3W
Resistance Tolerance	5%
T.C.R.	±300ppm/°C
Flameproof Multi-layer Coating Meets	UL-94V-0
Flameproof Feature Meets Overload Test	UL-1412

DERATING CURVE

For resistors operated in ambient temperatures above 70°C, power rating must be derated in accordance with the curve below.

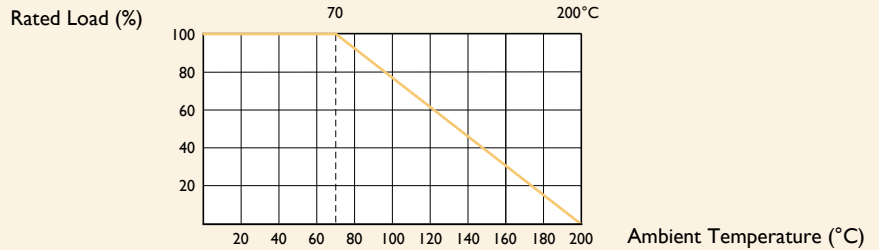

DIMENSIONS

Unit: mm

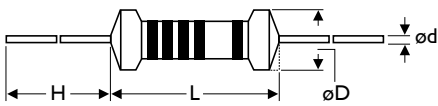

5th color code: yellow

STYLE		DIMENSION			
Normal	Miniature	L	øD	H	ød
APR-25	APR50S	6.3±0.5	2.4±0.2	28±2.0	0.55±0.05
APR-50	APR1WS	9.0±0.5	3.3±0.3	26±2.0	0.55±0.05
APR100	APR2WS	11.5±1.0	4.5±0.5	35±2.0	0.80±0.05
APR200	APR3WS	15.5±1.0	5.0±0.5	33±2.0	0.80±0.05

Note:

ELECTRICAL CHARACTERISTICS

STYLE	APR-25	APR50S	APR-50	APRIWS	APRI00	APR2WS	APR200	APR3WS
Power Rating at 70°C	1/4W	1/2W		1W		2W		3W
Maximum Working Voltage	250V	350V		400V	500V			
Maximum Overload Voltage	500V	600V	700V	800V	1,000V			
Voltage Proof	400V		500V	600V	750V			
Resistance Range	1 Ω - 100K Ω & 0 Ω for E24 series value							
Operating Temp. Range	-55°C to +200°C							
Temperature Coefficient	±300ppm/°C							

Note: Special value is available on request

ENVIRONMENTAL CHARACTERISTICS

PERFORMANCE TEST	TEST METHOD	APPRAISE
Short Time Overload	IEC 60115-1 4.13 2.5 times RCWV for 5 Sec.	±0.75%+0.05 Ω
Voltage Proof	IEC 60115-1 4.7 in V-block for 60 Sec., test voltage by type	By type
Temperature Coefficient	IEC 60115-1 4.8 -55°C to +155°C	By type
Insulation Resistance	IEC 60115-1 4.6 in V-block for 60 Sec.	>10,000M
Solderability	IEC 60115-1 4.17 235±5°C for 3±0.5 Sec.	95% Min. coverage
Solvent Resistance of Marking	IEC 60115-1 4.30 IPA for 5±0.5 Min. with ultrasonic	No deterioration of coatings and markings
Robustness of Terminations	IEC 60115-1 4.16 Direct load for 10 Sec. in the direction of the terminal leads	≥2.5kg (24.5N)
Periodic-pulse Overload	IEC 60115-1 4.39 4 times RCWV 10,000 cycles (1 Sec. on, 25 Sec. off)	±1.0%+0.05 Ω
Damp Heat Steady State	IEC 60115-1 4.24 40±2°C, 90-95% RH for 56 days, loaded with 0.1 times RCWV	±3.0%+0.05 Ω
Endurance at 70°C	IEC 60115-1 4.25 70±2°C at RCWV for 1,000 Hr. (1.5 Hr. on, 0.5 Hr. off)	±3.0%+0.05 Ω
Temperature Cycling	IEC 60115-1 4.19 -55°C ⇌ Room Temp. ⇌ +155°C ⇌ Room Temp. (5 cycles)	±1.0%+0.05 Ω
Resistance to Soldering Heat	IEC 60115-1 4.18 260±3°C for 10±1 Sec., immersed to a point 3±0.5mm from the body	±1.0%+0.05 Ω
Accidental Overload Test	IEC 60115-1 4.26 4 times RCWV for 1 Min.	No evidence of flaming or arcing

Note: Rated Continuous Working Voltage (RCWV) = $\sqrt{\text{Power Rating} \times \text{Resistance Value}}$

Zero Ohm Resistors

Coating Type

Normal Style [ZOR Series]



INTRODUCTION

- Similar to a 1/4W resistor (1/6W size also available)
- Ideal for automatic insertion or Cut and Form
- Available in Tape/Reel, Tape/Box and Bulk
- Products meet EU-RoHS requirements

SPECIFICATIONS

Power Rating	1/6W, 1/4W	
Maximum Resistance	20m Ω or less	
Min. Insulation Resistance	Dry	10,000M Ω
	Wet	100M Ω
Min. Dielectric Withstanding Voltage	Atmospheric	500V RMS
	Reduced	325V RMS
Insulation Flammability	Resistor insulation is self extinguishing within 10 Sec. after externally applied flame is removed	
Current Rating	2.5 AMPS at 70°C for 1/4W	
	1.5 AMPS at 70°C for 1/6W	

DERATING CURVE

For resistors operated in ambient temperatures above 70°C, power rating must be derated in accordance with the curve below.

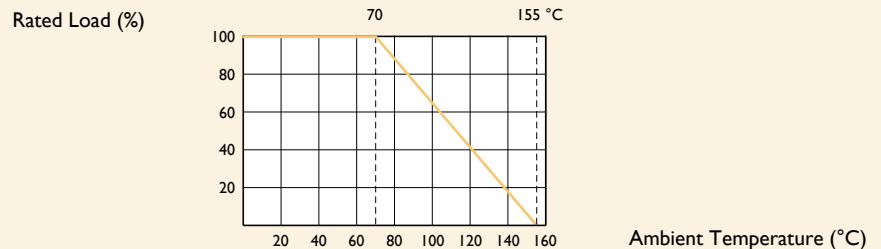

DIMENSIONS

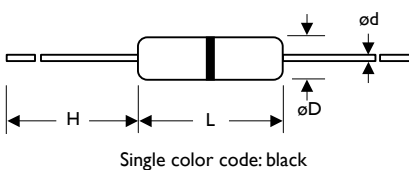

Unit: mm

STYLE	DIMENSION			
	L	øD	H	ød
Normal				
ZOR-12	3.3±0.4	1.8±0.3	28±2.0	0.45±0.05
ZOR-25	6.3±0.5	2.3±0.3	28±2.0	0.55±0.05

Tinned-Copper Wire Type

Normal Style [JPW Series]

Jumper Wires

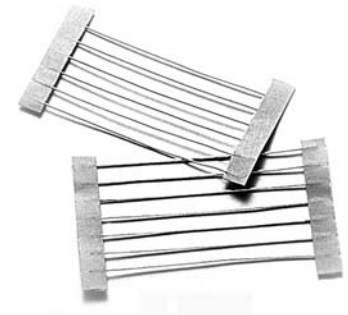

INTRODUCTION

Jumper wires or crossovers, as they are sometimes called, are basically interconnection devices between points on a PC Board. Generally they are used for the following reasons:

- Inability to connect two points on a PC Board due to other circuit paths which must be crossed over
 - An After-the-Fact design change that requires new point connections
 - Circuit tuning by changing point connections
- Jumper wires offers a quick simple solution to these problems. They are especially suited for automatic machine insertion on lead tape , and are available in all packaging styles, including pre-cut and formed leads, for manual insertion.
- Products meet EU-RoHS requirements

SPECIFICATIONS

Material of Jumper Wire	Soft copper wire with tin plating		
Wire Diameter	$\varnothing 0.5, \varnothing 0.6, \varnothing 0.7, \varnothing 0.8, \varnothing 1.0 (\pm 0.05\text{mm})$		
Tension Strength	CNS 8938 within 28kg/mm ²		
Extension Rate	CNS 8938 $\varnothing 0.5$ to $\varnothing 0.6\text{mm}$	over 24%	
	CNS 8938 $\varnothing 0.7$ to $\varnothing 1.0\text{mm}$	over 26%	
Conductivity	$\varnothing 0.5\text{mm}$	Minimum 94%	
	$\varnothing 0.6$ to $\varnothing 1.0\text{mm}$	Minimum 96%	
Twisting Strength	CNS 8938 $\varnothing 0.5\text{mm}$	Load 250g	3 cycles
	CNS 8938 $\varnothing 0.6$ to $\varnothing 0.8\text{mm}$	Load 500g	3 cycles
	CNS 8938 $\varnothing 1.0\text{mm}$	Load 1.0kg	3 cycles
Solderability	235 \pm 5°C, 3 \pm 0.5 Sec. coverage 95%		
Element of Plating	Tin Minimum 99.9%		
Thickness of Plating	4 \pm 1 μm		
	$\varnothing 0.5\text{mm}$	6 AMPS at 70°C	
	$\varnothing 0.6\text{mm}$	7.5 AMPS at 70°C	
	$\varnothing 0.7\text{mm}$	8.5 AMPS at 70°C	
	$\varnothing 0.8\text{mm}$	10 AMPS at 70°C	
Current Rating	$\varnothing 1.0\text{mm}$	15 AMPS at 70°C	
	Appearance		
	Smooth and shining		

DIMENSIONS

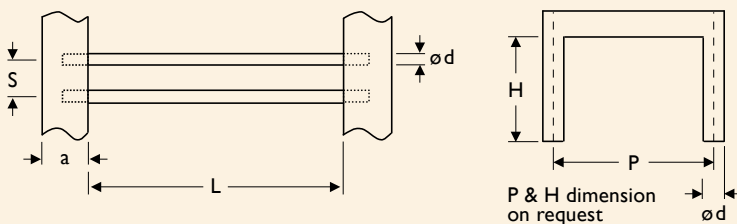

Unit: mm

STYLE	DIMENSION				
	Normal	$\varnothing d$	L	S	a
JPW-05		0.5 \pm 0.05			
JPW-06		0.6 \pm 0.05	26.0 \pm 1.0		
JPW-07		0.7 \pm 0.05	52.4 \pm 1.0	5.0 \pm 0.1	6.0 \pm 0.5
JPW-08		0.8 \pm 0.05	73.0 \pm 1.5		
JPW-10		1.0 \pm 0.05			

Low Ohmic Wire Resistors

Alloy-Wire Type

Normal Style [MCW Series]



FEATURES

Material	Manganese-copper; Nickel-copper; others upon request
Resistance Tolerance	±2%, ±5%
T.C.R.	±50ppm/°C, ±100ppm/°C, ±200ppm/°C

INTRODUCTION

- The Low Ohmic Alloy-Wire Resistors are suitable for high power current detection, it is non-inductive type
- Low Ohmic Wire Resistors meet EU-RoHS requirements

DIMENSIONS

Unit: mm

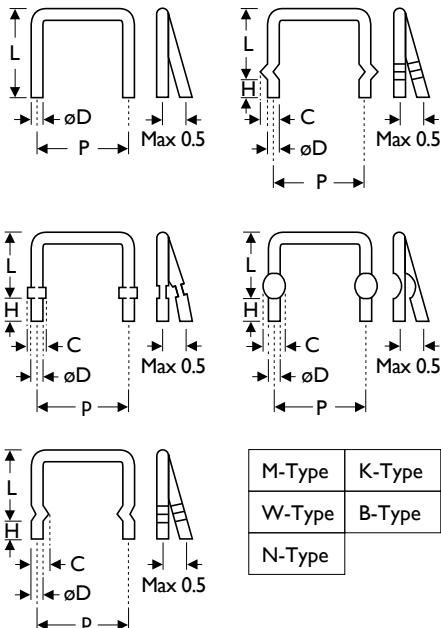

STYLE	DIMENSION			
	øD	C	H	P, L
MCW-06	0.6±0.02	0.9±0.1	3.0±0.5	P & L could be designed by customer's requirement
MCW-08	0.8±0.02	1.1±0.1	3.0±0.5	
MCW-10	1.0±0.02	1.3±0.1	3.0±0.5	
MCW-12	1.2±0.02	1.5±0.1	3.0±0.5	
MCW-14	1.4±0.02	1.7±0.1	3.0±0.5	
MCW-16	1.6±0.02	1.9±0.2	3.0±0.5	
MCW-18	1.8±0.02	2.2±0.2	3.0±0.5	
MCW-20	2.0±0.02	2.5±0.2	3.0±0.5	
MCW-26	2.6±0.02	3.2±0.2	3.0±0.5	

Note:

ELECTRICAL CHARACTERISTICS

STYLE	MCW-06	MCW-08	MCW-10	MCW-12	MCW-14	MCW-16	MCW-18	MCW-20	MCW-26
Maximum Current Rating	3A	4.5A	5.5A	7.0A	8.0A	9.5A	11A	12A	18A
Resistance Range	0.0014 Ω - 0.078 Ω								
Operating Temp. Range	-55°C to +125°C								
Temperature Coefficient	±50ppm/°C, ±100ppm/°C, ±200ppm/°C								

Note: Below or over this resistance value is available on request

ENVIRONMENTAL CHARACTERISTICS

PERFORMANCE TEST	TEST METHOD		APPRAISE
Short Time Overload	IEC 60115-1 4.13	2.5 times RCWV for 5 Sec.	±2%
Temperature Coefficient	IEC 60115-1 4.8	-55°C to +125°C	By type
Solderability	IEC 60115-1 4.17	235±5°C for 3±0.5 Sec.	95% Min. coverage
Damp Heat Steady State	IEC 60115-1 4.24	40±2°C, 90-95% RH for 56 days, loaded with 0.1 times RCWV	±2.0%
Endurance at 70°C	IEC 60115-1 4.25	70±2°C at RCWV for 1,000 Hr: (1.5 Hr: on, 0.5 Hr: off)	±3.0%
Temperature Cycling	IEC 60115-1 4.19	-55°C ⇌ Room Temp. ⇌ +155°C ⇌ Room Temp. (5 cycles)	±1.0%
Resistance to Soldering Heat	IEC 60115-1 4.18	260±3°C for 10±1 Sec., immersed to a point 3±0.5mm from the body	±1.0%

Note: Rated Continuous Working Voltage (RCWV) = $\sqrt{\text{Power Rating} \times \text{Resistance Value}}$

Wirewound Resistors

Flame-Proof Type

Normal & Miniature Style [KNP Series]

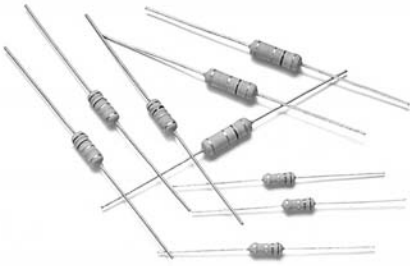

INTRODUCTION

The resistor element is a resistive wire which is wound in a single layer on a ceramic rod, with tinned connecting wires of electrolytic copper welded to the end-caps. The ends of the resistive wire and the leads are connected to the caps by welding. The resistors are coated with layers of green color flame-proof lacquer.

FEATURES

Power Rating	1/4W, 1/2W, 1W, 2W, 3W, 4W, 5W, 7W
Resistance Tolerance	±1%, ±5%
T.C.R.	±300ppm/°C
Flameproof Multi-layer Coating Meets	UL-94V-0
Flameproof Feature Meets Overload Test	UL-1412

DERATING CURVE

For resistors operated in ambient temperatures above 40°C, power rating must be derated in accordance with the curve below.

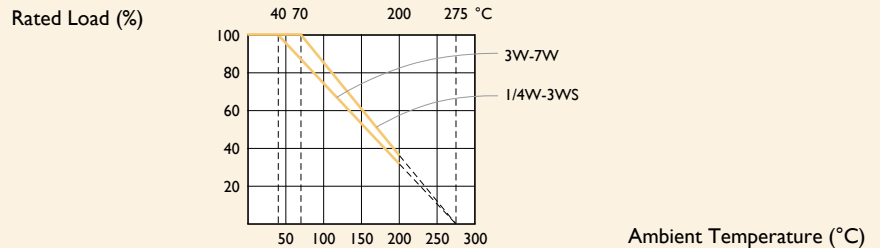

DIMENSIONS

Unit: mm

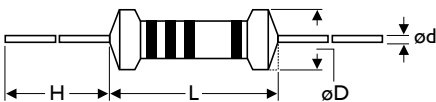

STYLE		DIMENSION			
Normal	Miniature	L	øD	H	ød
KNP-25	NP50S	6.3±0.5	2.4±0.2	28±2.0	0.55±0.05
KNP-50	KNP1WS	9.0±0.5	3.3±0.3	26±2.0	0.55±0.05
KNP100	KNP2WS	11.5±1.0	4.5±0.5	35±2.0	0.8±0.05
KNP200	KNP3WS	15.5±1.0	5.0±0.5	33±2.0	0.8±0.05
KNP300	KNP5WS	17.5±1.0	6.5±0.5	32±2.0	0.8±0.05
KNP400					
KNP500	KNP7WS	24.5±1.0	8.0±0.5	38±2.0	0.8±0.05
KNP700	-	24.5±1.0	8.0±0.5	38±2.0	0.8±0.05

Note: KNP1WS (for MBType) ød = 0.8±0.05 mm

ELECTRICAL CHARACTERISTICS

NORMAL STYLE

STYLE	KNP-25	KNP-50	KNP100	KNP200	KNP300	KNP400	KNP500	KNP700
Power Rating at 40°C					3W	4W	5W	7W
Power Rating at 70°C	1/4W	1/2W	1W	2W				
Voltage Proof	250V	300V	400V					
Resistance Range (±1%)	0.22 Ω - 150 Ω	0.1 Ω - 800 Ω	0.1 Ω - 1.8K Ω	0.1 Ω - 2.8K Ω	0.1 Ω - 7.5K Ω		0.1 Ω - 6.5K Ω	
Resistance Range (±5%)	0.05 Ω - 200 Ω	0.03 Ω - 800 Ω	0.015 Ω - 2.2K Ω	0.015 Ω - 2.8K Ω	0.02 Ω - 7.5K Ω		0.03 Ω - 6.8K Ω	
Operating Temp. Range	-40°C to +200°C							
Temperature Coefficient	±300ppm/°C							

Note: Special value is available on request

MINIATURE STYLE

STYLE	KNP50S	KNPIWS	KNP2WS	KNP3WS	KNP5WS	KNP7WS
Power Rating at 40°C					5W	7W
Power Rating at 70°C	1/2W	1W	2W	3W		
Voltage Proof	200V	300V	400V			
Resistance Range (±1%)	0.22 Ω - 150 Ω	0.1 Ω - 800 Ω	0.1 Ω - 1.8K Ω	0.1 Ω - 2.8K Ω	0.1 Ω - 7.5K Ω	0.1 Ω - 6.5K Ω
Resistance Range (±5%)	0.05 Ω - 200 Ω	0.03 Ω - 800 Ω	0.015 Ω - 2.2K Ω	0.015 Ω - 2.8K Ω	0.02 Ω - 7.5K Ω	0.03 Ω - 6.8K Ω
Operating Temp. Range	-40°C to +200°C					
Temperature Coefficient	±300ppm/°C					

Note: Special value is available on request

ENVIRONMENTAL CHARACTERISTICS

PERFORMANCE TEST	TEST METHOD		APPRAISE
Short Time Overload	IEC 60115-1 4.13	10 times rated power for 5 Sec.	±2.0%+0.05 Ω
Voltage Proof	IEC 60115-1 4.7	in V-block for 60 Sec., test voltage by type	By type
Temperature Coefficient	IEC 60115-1 4.8	-55°C to +155°C	By type
Insulation Resistance	IEC 60115-1 4.6	in V-block for 60 Sec.	>100M Ω
Solderability	IEC 60115-1 4.17	235±5°C for 3±0.5 Sec	95% Min. coverage
Solvent Resistance of Marking	IEC 60115-1 4.30	IPA for 5±0.5 Min. with ultrasonic	No deterioration of coatings and markings
Robustness of Terminations	IEC 60115-1 4.16	Direct load for 10 Sec. in the direction of the terminal leads	≥2.5kg (24.5N)
Damp Heat Steady State	IEC 60115-1 4.24	40±2°C, 90-95% RH for 56 days, loaded with 0.1 times RCWV	±5.0%+0.05 Ω
Endurance at 70°C	IEC 60115-1 4.25	70±2°C at RCWV for 1,000 Hr. (1.5 Hr. on, 0.5 Hr. off)	±5.0%+0.05 Ω
Temperature Cycling	IEC 60115-1 4.19	-55°C ⇌ Room Temp. ⇌ +155°C ⇌ Room Temp. (5 cycles)	±1.0%+0.05 Ω
Resistance to Soldering Heat	IEC 60115-1 4.18	260±3°C for 10±1 Sec., immersed to a point 3±0.5mm from the body	±1.0%+0.05 Ω
Accidental Overload Test	IEC 60115-1 4.26	4 times RCWV for 1 Min.	No evidence of flaming or arcing

Note: Rated Continuous Working Voltage (RCWV) = $\sqrt{\text{Power Rating} \times \text{Resistance Value}}$

Wirewound Resistors

Flame-Proof & Non-Inductive Type

Normal & Miniature Style [NKN Series]

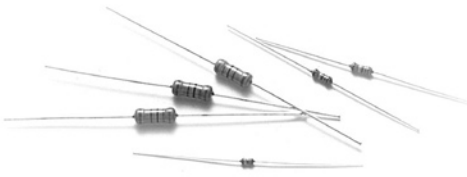

INTRODUCTION

The resistor element is a resistive wire which is wound in a single layer on a ceramic rod, with tinned connecting wires of electrolytic copper welded to the end-caps. The ends of the resistive wire and the leads are connected to the caps by welding. The resistors are coated with layers of green color flame-proof lacquer. The 5th color band is black to represent NKN series.

FEATURES

Power Rating	1/2W, 1W, 2W, 3W, 4W, 5W, 7W
Resistance Tolerance	±5%
T.C.R.	±300ppm/°C
Flameproof Multi-layer Coating Meets	UL-94V-0
Flameproof Feature Meets Overload Test	UL-1412

DERATING CURVE

For resistors operated in ambient temperatures above 40°C, power rating must be derated in accordance with the curve below.

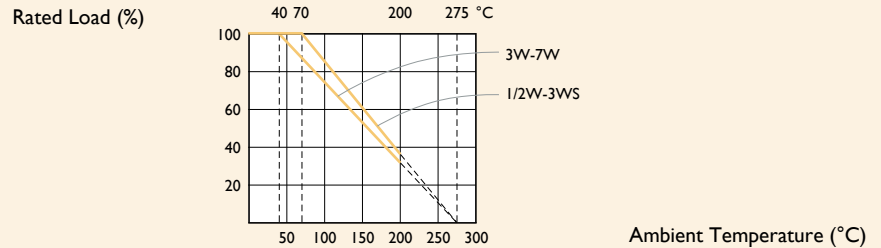

DIMENSIONS

Unit: mm

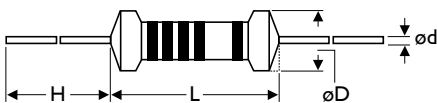

5th color code: black

STYLE		DIMENSION			
Normal	Miniature	L	øD	H	ød
NKN-50	NKN1WS	9.0±0.5	3.3±0.3	26±2.0	0.55±0.05
NKN100	NKN2WS	11.5±1.0	4.5±0.5	35±2.0	0.8±0.05
NKN200	NKN3WS	15.5±1.0	5.0±0.5	33±2.0	0.8±0.05
NKN300					
NKN400	NKN5WS	17.5±1.0	6.5±0.5	32±2.0	0.8±0.05
NKN500	NKN7WS	24.5±1.0	8.0±0.5	38±2.0	0.8±0.05

ELECTRICAL CHARACTERISTICS

NORMAL STYLE

STYLE	NKN-50	NKN100	NKN200	NKN300	NKN400	NKN500
Power Rating at 40°C				3W	4W	5W
Power Rating at 70°C	1/2W	1W	2W			
Voltage Proof	250V	400V				
Resistance Range	0.08 Ω - 15 Ω	0.05 Ω - 40 Ω	0.03 Ω - 90 Ω	0.1 Ω - 120 Ω		0.18 Ω - 220 Ω
Operating Temp. Range	-40°C to +200°C					
Temperature Coefficient	±300ppm/°C					

Note: Special value is available on request

MINIATURE STYLE

STYLE	NKNIWS	NKN2WS	NKN3WS	NKN5WS	NKN7WS
Power Rating at 40°C				5W	7W
Power Rating at 70°C	1W	2W	3W		
Voltage Proof	250V	400V			
Resistance Range	0.08 Ω - 15 Ω	0.05 Ω - 40 Ω	0.03 Ω - 90 Ω	0.1 Ω - 120 Ω	0.18 Ω - 220 Ω
Operating Temp. Range	- 40°C to +200°C				
Temperature Coefficient	±300ppm/°C				

Note: Special value is available on request

ENVIRONMENTAL CHARACTERISTICS

PERFORMANCE TEST	TEST METHOD		APPRAISE
Short Time Overload	IEC 60115-1 4.13	10 times rated power for 5 Sec.	±2.0%+0.05 Ω
Voltage Proof	IEC 60115-1 4.7	in V-block for 60 Sec., test voltage by type	By type
Temperature Coefficient	IEC 60115-1 4.8	-55°C to +155°C	By type
Insulation Resistance	IEC 60115-1 4.6	in V-block for 60 Sec.	>100M Ω
Solderability	IEC 60115-1 4.17	235±5°C for 3±0.5 Sec.	95% Min. coverage
Solvent Resistance of Marking	IEC 60115-1 4.30	IPA for 5±0.5 Min. with ultrasonic	No deterioration of coatings and markings
Robustness of Terminations	IEC 60115-1 4.16	Direct load for 10 Sec. in the direction of the terminal leads	≥2.5kg (24.5N)
Damp Heat Steady State	IEC 60115-1 4.24	40±2°C, 90-95% RH for 56 days, loaded with 0.1 times RCWV	±5.0%+0.05 Ω
Endurance at 70°C	IEC 60115-1 4.25	70±2°C at RCWV for 1,000 Hr. (1.5 Hr. on, 0.5 Hr. off)	±5.0%+0.05 Ω
Temperature Cycling	IEC 60115-1 4.19	-55°C ⇄ Room Temp. ⇄ +155°C ⇄ Room Temp. (5 cycles)	±1.0%+0.05 Ω
Resistance to Soldering Heat	IEC 60115-1 4.18	260±3°C for 10±1 Sec., immersed to a point 3±0.5mm from the body	±1.0%+0.05 Ω
Accidental Overload Test	IEC 60115-1 4.26	4 times RCWV for 1 Min.	No evidence of flaming or arcing

Note: Rated Continuous Working Voltage (RCWV) = $\sqrt{\text{Power Rating} \times \text{Resistance Value}}$

Wirewound Resistors

Fusible & Flame-Proof Type

Normal & Miniature Style [FKN Series]

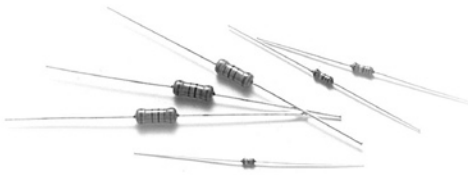

INTRODUCTION

The resistor element is a resistive wire which is wound in a single layer on a ceramic rod, with tinned connecting wires of electrolytic copper welded to the end-caps. The ends of the resistive wire and the leads are connected to the caps by welding. The resistors are coated with layers of green color flame-proof lacquer. Overload protection without risk of fire. Wide range of overload currents.

FEATURES

Power Rating	1/4W, 1/2W, 1W, 2W, 3W, 4W, 5W, 7W
Resistance Tolerance	±1%, ±5%
T.C.R.	±350ppm/°C
Flameproof Multi-layer Coating Meets	UL-94V-0
Flameproof Feature Meets Overload Test	UL-1412

DERATING CURVE

For resistors operated in ambient temperatures above 40°C, power rating must be derated in accordance with the curve below.

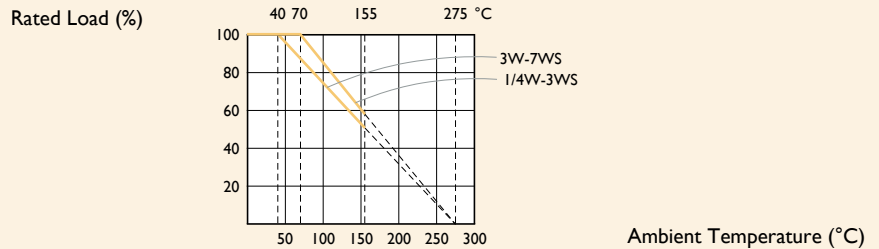

FUSING CHARACTERISTICS

$R \leq 2.0 \Omega$ Fusing time within 60 seconds at 36 times of rated power

$R > 2.0 \Omega$ Fusing time within 60 seconds at 25 times of rated power

Fusing residual resistive value at least 100 times rated resistance

DIMENSIONS

Unit: mm

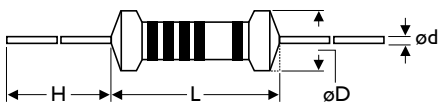

5th color code: white

STYLE	DIMENSION					
	Normal	Miniature	L	øD	H	ød
FKN-25		FKN50S	6.3±0.5	2.4±0.2	28±2.0	0.55±0.05
FKN-50		FKN1WS	9.0±0.5	3.3±0.3	26±2.0	0.55±0.05
FKN-100		FKN2WS	11.5±1.0	4.5±0.5	35±2.0	0.8±0.05
FKN-200		FKN3WS	15.5±1.0	5.0±0.5	33±2.0	0.8±0.05
FKN-300						
FKN-400		FKN5WS	17.5±1.0	6.5±0.5	32±2.0	0.8±0.05
FKN-500		FKN7WS	24.5±1.0	8.0±0.5	38±2.0	0.8±0.05

Note: FKN1WS (for MBType) ød = 0.8±0.05 mm

ELECTRICAL CHARACTERISTICS

NORMAL STYLE

STYLE	FKN-25	FKN-50	FKN100	FKN200	FKN300	FKN400	FKN500
Power Rating at 40°C					3W	4W	5W
Power Rating at 70°C	1/4W	1/2W	1W	2W			
Voltage Proof	200V	300V					
Resistance Range (±1%)			0.5 Ω - 100 Ω	0.47 Ω - 150 Ω	0.56 Ω - 330 Ω		1 Ω - 620 Ω
Resistance Range (±5%)	2.5 Ω - 22 Ω	0.5 Ω - 47 Ω	0.5 Ω - 100 Ω	0.47 Ω - 150 Ω	0.56 Ω - 330 Ω		1 Ω - 620 Ω
Operating Temp. Range	-40°C to +155°C						
Temperature Coefficient	±350ppm/°C						

Note: Special value is available on request

MINIATURE STYLE

STYLE	FKN50S	FKNIWS	FKN2WS	FKN3WS	FKN5WS	FKN7WS
Power Rating at 40°C					5W	7W
Power Rating at 70°C	1/2W	1W	2W	3W		
Voltage Proof	200V	300V				
Resistance Range (±1%)		0.47 Ω - 62 Ω	0.47 Ω - 150 Ω	0.47 Ω - 240 Ω	0.56 Ω - 330 Ω	1 Ω - 620 Ω
Resistance Range (±5%)	2.5 Ω - 22 Ω	0.47 Ω - 62 Ω	0.47 Ω - 150 Ω	0.47 Ω - 240 Ω	0.56 Ω - 330 Ω	1 Ω - 620 Ω
Operating Temp. Range	-40°C to +155°C					
Temperature Coefficient	±350ppm/°C					

Note: Special value is available on request

ENVIRONMENTAL CHARACTERISTICS

PERFORMANCE TEST	TEST METHOD		APPRAISE
Short Time Overload	IEC 60115-1 4.13	10 times rated power for 5 Sec.	±2.0%+0.05 Ω
Voltage Proof	IEC 60115-1 4.7	in V-block for 60 Sec., test voltage by type	By type
Temperature Coefficient	IEC 60115-1 4.8	-55°C to +155°C	By type
Insulation Resistance	IEC 60115-1 4.6	in V-block for 60 Sec.	>100M Ω
Solderability	IEC 60115-1 4.17	235±5°C for 3±0.5 Sec.	95% Min. coverage
Solvent Resistance of Marking	IEC 60115-1 4.30	IPA for 5±0.5 Min. with ultrasonic	No deterioration of coatings and markings
Robustness of Terminations	IEC 60115-1 4.16	Direct load for 10 Sec. in the direction of the terminal leads	≥2.5kg (24.5N)
Damp Heat Steady State	IEC 60115-1 4.24	40±2°C, 90-95% RH for 56 days, loaded with 0.1 times RCWV	±5.0%+0.05 Ω
Endurance at 70°C	IEC 60115-1 4.25	70±2°C at RCWV for 1,000 Hr. (1.5 Hr. on, 0.5 Hr. off)	±5.0%+0.05 Ω
Temperature Cycling	IEC 60115-1 4.19	-55°C ⇄ Room Temp. ⇄ +155°C ⇄ Room Temp. (5 cycles)	±1.0%+0.05 Ω
Resistance to Soldering Heat	IEC 60115-1 4.18	260±3°C for 10±1 Sec., immersed to a point 3±0.5mm from the body	±1.0%+0.05 Ω
Accidental Overload Test	IEC 60115-1 4.26	4 times RCWV for 1 Min.	No evidence of flaming or arcing

Note: Rated Continuous Working Voltage (RCWV) = $\sqrt{\text{Power Rating} \times \text{Resistance Value}}$

Wirewound Resistors

High Power Type

Ultra Miniature Style [PNP Series]

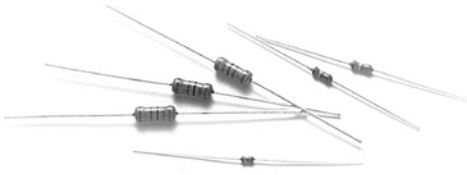

INTRODUCTION

The resistor element is a resistive wire which is wound in a single layer on a ceramic rod, with tinned connecting wires of electrolytic copper welded to the end-caps. The ends of the resistive wire and the leads are connected to the caps by welding. The resistors are coated with layers of green color flame-proof lacquer. High power in small packages.

FEATURES

Power Rating	1W, 2W, 3W, 4W
Resistance Tolerance	±1%, ±5%
T.C.R.	±300ppm/°C
Flameproof Multi-layer Coating Meets	UL-94V-0
Flameproof Feature Meets Overload Test	UL-1412

DERATING CURVE

For resistors operated in ambient temperatures above 70°C, power rating must be derated in accordance with the curve below.

Rated Load (%)

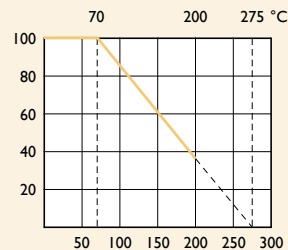

Ambient Temperature (°C)

DIMENSIONS

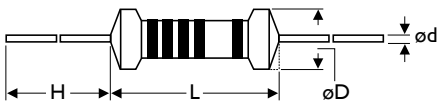

5th color code: violet

Unit: mm

STYLE	DIMENSION			
	L	øD	H	ød
Ultra Miniature				
PNP100	6.3±0.5	2.4±0.2	28±2.0	0.55±0.05
PNP200	9.0±0.5	3.3±0.3	26±2.0	0.55±0.05
PNP300	11.5±1.0	4.5±0.5	35±2.0	0.8±0.05
PNP400	15.5±1.0	5.0±0.5	33±2.0	0.8±0.05

Note:

ELECTRICAL CHARACTERISTICS

STYLE	PNP100	PNP200	PNP300	PNP400
Power Rating at 70°C	1W	2W	3W	4W
Dielectric Withstanding Voltage	300V			
Resistance Range (±1%)	0.22 Ω - 130 Ω	0.1 Ω - 820 Ω	0.1 Ω - 2.2K Ω	0.1 Ω - 2.8K Ω
Resistance Range (±5%)	0.1 Ω - 130 Ω	0.068 Ω - 820 Ω	0.025 Ω - 2.2K Ω	0.03 Ω - 2.8K Ω
Operating Temp. Range	-40°C to +200°C			
Temperature Coefficient	±300ppm/°C			

Note: Special value is available on request

ENVIRONMENTAL CHARACTERISTICS

PERFORMANCE TEST	TEST METHOD	APPRAISE
Short Time Overload	IEC 60115-1 4.13 10 times rated power for 5 Sec.	±2.0%+0.05 Ω
Voltage Proof	IEC 60115-1 4.7 in V-block for 60 Sec., test voltage by type	By type
Temperature Coefficient	IEC 60115-1 4.8 -55°C to +155°C	By type
Insulation Resistance	IEC 60115-1 4.6 in V-block for 60 Sec.	>100M Ω
Solderability	IEC 60115-1 4.17 235±5°C for 3±0.5 Sec.	95% Min. coverage
Solvent Resistance of Marking	IEC 60115-1 4.30 IPA for 5±0.5 Min. with ultrasonic	No deterioration of coatings and markings
Robustness of Terminations	IEC 60115-1 4.16 Direct load for 10 Sec. in the direction of the terminal leads	≥2.5kg (24.5N)
Damp Heat Steady State	IEC 60115-1 4.24 40±2°C, 90-95% RH for 56 days, loaded with 0.1 times RCWV	±5.0%+0.05 Ω
Endurance at 70°C	IEC 60115-1 4.25 70±2°C at RCWV for 1,000 Hr. (1.5 Hr. on, 0.5 Hr. off)	±5.0%+0.05 Ω
Temperature Cycling	IEC 60115-1 4.19 -55°C ⇌ Room Temp. ⇌ +155°C ⇌ Room Temp. (5 cycles)	±1.0%+0.05 Ω
Resistance to Soldering Heat	IEC 60115-1 4.18 260±3°C for 10±1 Sec., immersed to a point 3±0.5mm from the body	±1.0%+0.05 Ω
Accidental Overload Test	IEC 60115-1 4.26 4 times RCWV for 1 Min.	No evidence of flaming or arcing

Note: Rated Continuous Working Voltage (RCWV) = $\sqrt{\text{Power Rating} \times \text{Resistance Value}}$

Wirewound Resistors

High Power Type

Normal Style [PNP V Series]

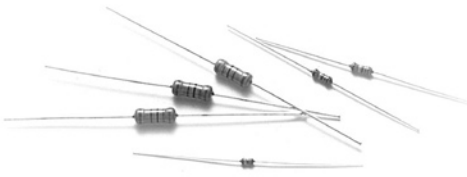

INTRODUCTION

The resistor element is a resistive wire which is wound in a single layer on a ceramic rod, with tinned connecting wires of electrolytic copper welded to the end-caps. The ends of the resistive wire and the leads are connected to the caps by welding. The resistors are coated with layers of green color flame-proof lacquer. High power in small package. The 5th color band is violet to represent PNPV series.

FEATURES

Power Rating	1W, 3W, 4W, 5W, 7W, 10W
Resistance Tolerance	±1%, ±5%
T.C.R.	±100ppm/°C, ±300ppm/°C
Flameproof Multi-layer Coating Meets	UL-94V-0
Flameproof Feature Meets Overload Test	UL-1412

DERATING CURVE

For resistors operated in ambient temperatures above 40°C, power rating must be derated in accordance with the curve below.

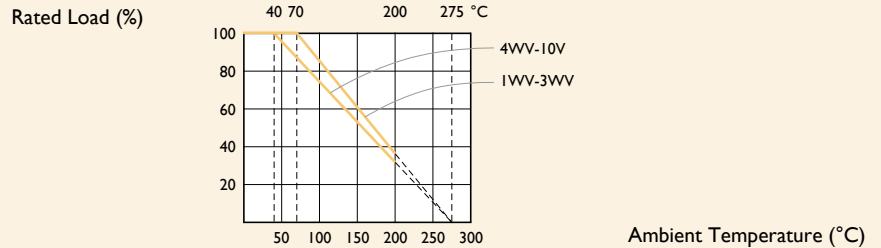

DIMENSIONS

Unit: mm

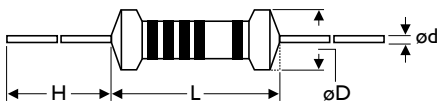

5th color code: violet

STYLE	DIMENSION			
	L	øD	H	ød
PNP1WV	10±1.0	4.3±0.5	26±2.0	0.8±0.05
PNP3WV	13±1.0	5.5±0.5	34±2.0	0.8±0.05
PNP4WV	17±1.0	5.5±0.5	32±2.0	0.8±0.05
PNP5WV	17±1.0	7.5±0.5	32±2.0	0.8±0.05
PNP7WV	25±1.0	7.5±0.5	38±2.0	0.8±0.05
PNP10V	44±1.0	8.0±0.5	28±2.0	0.8±0.05

Note:

ELECTRICAL CHARACTERISTICS

STYLE	PNPIWV	PNP3WV	PNP4WV	PNP5WV	PNP7WV	PNPI0V
Power Rating at 40°C			4W	5W	7W	10W
Power Rating at 70°C	1W	3W				
Voltage Proof	300V					
Resistance Range (±1%)	0.1 Ω - 1K Ω	0.1 Ω - 2.8K Ω	0.1 Ω - 4.3K Ω	0.1 Ω - 8.2K Ω	0.1 Ω - 10K Ω	0.1 Ω - 17K Ω
Resistance Range (±5%)	0.03 Ω - 1K Ω	0.015 Ω - 2.8K Ω	0.02 Ω - 4.3K Ω	0.025 Ω - 8.2K Ω	0.03 Ω - 10K Ω	0.1 Ω - 17K Ω
Operating Temp. Range	-40°C to +200°C					
Temperature Coefficient	±300ppm/°C					

Note: Special value is available on request

ENVIRONMENTAL CHARACTERISTICS

PERFORMANCE TEST	TEST METHOD		APPRAISE
Short Time Overload	IEC 60115-1 4.13	10 times rated power for 5 Sec.	±2.0%+0.05 Ω
Voltage Proof	IEC 60115-1 4.7	in V-block for 60 Sec., test voltage by type	By type
Temperature Coefficient	IEC 60115-1 4.8	-55°C to +155°C	By type
Insulation Resistance	IEC 60115-1 4.6	in V-block for 60 Sec.	>100M Ω
Solderability	IEC 60115-1 4.17	235±5°C for 3±0.5 Sec.	95% Min. coverage
Solvent Resistance of Marking	IEC 60115-1 4.30	IPA for 5±0.5 Min. with ultrasonic	No deterioration of coatings and markings
Robustness of Terminations	IEC 60115-1 4.16	Direct load for 10 Sec. in the direction of the terminal leads	≥2.5kg (24.5N)
Damp Heat Steady State	IEC 60115-1 4.24	40±2°C, 90-95% RH for 56 days, loaded with 0.1 times RCWV	±5.0%+0.05 Ω
Endurance at 70°C	IEC 60115-1 4.25	70±2°C at RCWV for 1,000 Hr. (1.5 Hr. on, 0.5 Hr. off)	±5.0%+0.05 Ω
Temperature Cycling	IEC 60115-1 4.19	-55°C ⇌ Room Temp. ⇌ +155°C ⇌ Room Temp. (5 cycles)	±1.0%+0.05 Ω
Resistance to Soldering Heat	IEC 60115-1 4.18	260±3°C for 10±1 Sec., immersed to a point 3±0.5mm from the body	±1.0%+0.05 Ω
Accidental Overload Test	IEC 60115-1 4.26	4 times RCWV for 1 Min.	No evidence of flaming or arcing

Note: Rated Continuous Working Voltage (RCWV) = $\sqrt{\text{Power Rating} \times \text{Resistance Value}}$

Cement Resistors

Axial Lead Type

Normal Style [SQP Series]
 Non-Inductive Style [NSP Series]

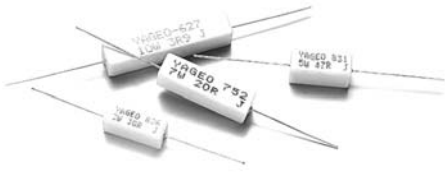

INTRODUCTION

The materials used and the construction techniques ensure excellent flame resistance, arc resistance and moisture resistance as well as self-extinguishing capabilities. They will withstand the most rigorous loading test.

As resistors in radio and television receivers, hazardous conditions such as smoking and redheat can be completely prevented by the proper choice of power resistors.

FEATURES

Power Rating	2W, 3W, 5W, 7W, 10W, 15W, 20W, 25W, 30W, 40W
Resistance Tolerance	±5%
T.C.R.	±300ppm/°C

DERATING CURVE

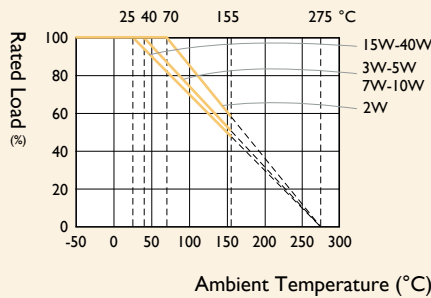

TEMPERATURE RISE

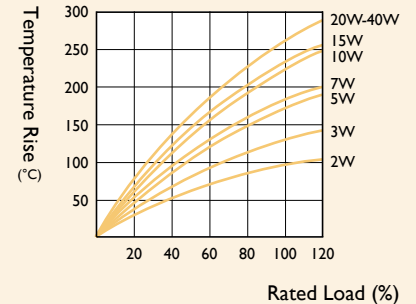

DIMENSIONS

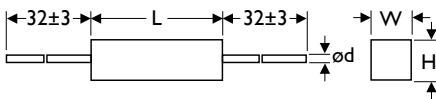

Unit: mm

STYLE		DIMENSION			
Normal	Non-Inductive	L	W	H	ød
SQP200	NSP200	18±1.0	7.0±1.0	7.0±1.0	0.65±0.05
SQP300	NSP300	22±1.5	8.0±1.0	8.0±1.0	0.8±0.05
SQP500	NSP500	22±1.5	9.5±1.0	9.0±1.0	0.8±0.05
SQP700	NSP700	35±1.5	9.5±1.0	9.0±1.0	0.8±0.05
SQP10A	NSP10A	48±1.5	9.5±1.0	9.0±1.0	0.8±0.05
SQP15A	NSP15A	48±1.5	12.5±1.0	12.5±1.0	0.8±0.05
SQP20A	NSP20A	60±5.0	12.5±1.0	12.5±1.0	0.8±0.05
SQP25A	NSP25A	60±5.0	14.0±1.5	13.0±1.5	0.8±0.05
SQP30A	NSP30A	77±5.0	18.0±1.5	17.0±1.5	0.8±0.05
SQP40A	NSP40A	90±5.0	19.0±1.5	18.0±1.5	0.8±0.05

ELECTRICAL CHARACTERISTICS

NORMAL STYLE

STYLE	SQP200	SQP300	SQP500	SQP700	SQP10A	SQP15A	SQP20A	SQP25A	SQP30A	SQP40A
Power Rating at 25°C						15W	20W	25W	30W	40W
Power Rating at 40°C		3W	5W	7W	10W					
Power Rating at 70°C	2W									
Maximum Working Voltage	250V	350V		500V				1,000V		
Maximum Overload Voltage	500V	700V		1,000V				2,000V		
Voltage Proof	500V	700V		1,000V				2,000V		
Resistance Range (Wirewound)	0.03 Ω - 36 Ω	0.015 Ω - 68 Ω	0.015 Ω - 130 Ω	0.05 Ω - 330 Ω	0.08 Ω - 510 Ω	0.1 Ω - 680 Ω	0.15 Ω - 1K Ω			
Resistance Range (Metal Oxide Film)	39 Ω - 1M Ω	75 Ω - 1M Ω	150 Ω - 1M Ω	360 Ω - 1M Ω	560 Ω - 1M Ω	750 Ω - 1M Ω	1.2K Ω - 1M Ω			
Operating Temp. Range	-55°C to +155°C									
Temperature Coefficient	±300ppm/°C									

NON-INDUCTIVE STYLE

STYLE	NSP200	NSP300	NSP500	NSP700	NSP10A	NSP15A	NSP20A	NSP25A	NSP30A	NSP40A
Power Rating at 25°C						15W	20W	25W	30W	40W
Power Rating at 40°C		3W	5W	7W	10W					
Power Rating at 70°C	2W									
Maximum Working Voltage	250V	350V		500V				1,000V		
Maximum Overload Voltage	500V	700V		1,000V				2,000V		
Voltage Proof	500V	700V		1,000V				2,000V		
Resistance Range (Wirewound)	0.08 Ω - 10 Ω	0.033 Ω - 30 Ω	0.03 Ω - 40 Ω	0.15 Ω - 65 Ω	0.25 Ω - 100 Ω	0.25 Ω - 120 Ω	0.36 Ω - 160 Ω			
Operating Temp. Range	-55°C to +155°C									
Temperature Coefficient	±300ppm/°C									

Note: Special value is available on request

ENVIRONMENTAL CHARACTERISTICS

PERFORMANCE TEST	TEST METHOD		APPRAISE
Short Time Overload	IEC 60115-1 4.13	2.5 times RCWV for 5 Sec.	±2.0%+0.05 Ω
Voltage Proof	IEC 60115-1 4.7	in V-block for 60 Sec., test voltage by type	By type
Temperature Coefficient	IEC 60115-1 4.8	-55°C to +155°C	By type
Insulation Resistance	IEC 60115-1 4.6	in V-block for 60 Sec.	>1,000M Ω
Solderability	IEC 60115-1 4.17	235±5°C for 3±0.5 Sec.	95% Min. coverage
Solvent Resistance of Marking	IEC 60115-1 4.30	IPA for 5±0.5 Min. with ultrasonic	No deterioration of coatings and markings
Robustness of Terminations	IEC 60115-1 4.16	Direct load for 10 Sec. in the direction of the terminal leads	≥2.5kg (24.5N)
Periodic-pulse Overload	IEC 60115-1 4.39	4 times RCWV 10,000 cycles (1 Sec. on, 25 Sec. off)	±2.0%+0.05 Ω
Damp Heat Steady State	IEC 60115-1 4.24	40±2°C, 90-95% RH for 56 days, loaded with 0.1 times RCWV	±5.0%+0.05 Ω
Endurance at 70°C	IEC 60115-1 4.25	70±2°C at RCWV for 1,000 Hr. (1.5 Hr. on, 0.5 Hr. off)	±5.0%+0.05 Ω
Temperature Cycling	IEC 60115-1 4.19	-55°C ⇌ Room Temp. ⇌ +155°C ⇌ Room Temp. (5 cycles)	±2.0%+0.05 Ω
Resistance to Soldering Heat	IEC 60115-1 4.18	260±3°C for 10±1 Sec., immersed to a point 3±0.5mm from the body	±1.0%+0.05 Ω

Note: Rated Continuous Working Voltage (RCWV) = $\sqrt{\text{Power Rating} \times \text{Resistance Value}}$

Cement Resistors

Vertical Lead Type

Normal Style [SQM Series]

Non-Inductive Style [NSM Series]



INTRODUCTION

The materials used and the construction techniques ensure excellent flame resistance, arc resistance and moisture resistance as well as self-extinguishing capabilities. They will withstand the most rigorous loading test.

As resistors in radio and television receivers, hazardous conditions such as smoking and redheat can be completely prevented by the proper choice of power resistors.

FEATURES

Power Rating	2W, 3W, 5W, 7W, 10W
Resistance Tolerance	±5%
T.C.R.	±300ppm/°C

DERATING CURVE

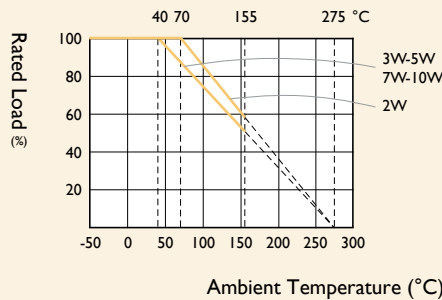

TEMPERATURE RISE

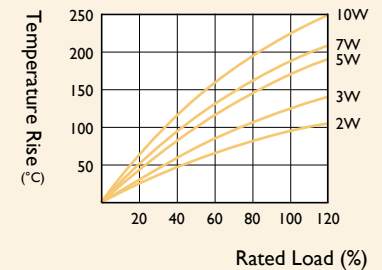

DIMENSIONS

Unit: mm

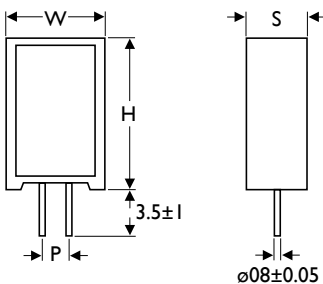

STYLE		DIMENSION			
Normal	Non-Ind.	H	W	S	P
SQM200	NSM200	20±1.5	11.0±1.0	7.0±1.0	5 ⁺²⁻¹
SQM300	NSM300	25±1.5	12.0±1.0	8.0±1.0	5 ⁺²⁻¹
SQM500	NSM500	25±1.5	13.0±1.0	9.0±1.0	5 ⁺²⁻¹
SQM700	NSM700	39±1.5	13.0±1.0	9.0±1.0	5 ⁺²⁻¹
SQM10A	NSM10A	51±1.5	13.0±1.0	9.0±1.0	5 ⁺²⁻¹
SQM10S	NSM10S	35±1.5	16.0±1.0	12.0±1.0	7 ⁺²⁻¹

ELECTRICAL CHARACTERISTICS

NORMAL STYLE

STYLE	SQM200	SQM300	SQM500	SQM700	SQM10A	SQM10S
Power Rating at 40°C		3W	5W	7W	10W	
Power Rating at 70°C	2W					
Maximum Working Voltage	250V	350V		500V		
Maximum Overload Voltage	500V	700V		1,000V		
Voltage Proof	500V	700V		1,000V		
Resistance Range (Wirewound)	0.03 Ω - 36 Ω	0.015 Ω - 68 Ω	0.015 Ω - 130 Ω	0.05 Ω - 330 Ω	0.08 Ω - 510 Ω	0.03 Ω - 270 Ω
Resistance Range (Metal Oxide Film)	12 Ω - 1M Ω	75 Ω - 1M Ω	150 Ω - 1M Ω	360 Ω - 1M Ω	560 Ω - 1M Ω	300 Ω - 1M Ω
Operating Temp. Range	-55°C to +155°C					
Temperature Coefficient	±300ppm/°C					

NON-INDUCTIVE STYLE

STYLE	NSM200	NSM300	NSM500	NSM700	NSM10A	NSM10S
Power Rating at 40°C		3W	5W	7W	10W	
Power Rating at 70°C	2W					
Maximum Working Voltage	250V	350V		500V		
Maximum Overload Voltage	500V	700V		1,000V		
Voltage Proof	500V	700V		1,000V		
Resistance Range (Wirewound)	0.08 Ω - 10 Ω	0.033 Ω - 30 Ω	0.15 Ω - 65 Ω	0.25 Ω - 100 Ω	0.12 Ω - 100 Ω	0.12 Ω - 50 Ω
Operating Temp. Range	-55°C to +155°C					
Temperature Coefficient	±300ppm/°C					

Note: Special value is available on request

ENVIRONMENTAL CHARACTERISTICS

PERFORMANCE TEST	TEST METHOD		APPRAISE
Short Time Overload	IEC 60115-1 4.13	2.5 times RCWV for 5 Sec.	±2.0%+0.05 Ω
Voltage Proof	IEC 60115-1 4.7	in V-block for 60 Sec., test voltage by type	By type
Temperature Coefficient	IEC 60115-1 4.8	-55°C to +155°C	By type
Insulation Resistance	IEC 60115-1 4.6	in V-block for 60 Sec.	>1,000M Ω
Solderability	IEC 60115-1 4.17	235±5°C for 3±0.5 Sec.	95% Min. coverage
Solvent Resistance of Marking	IEC 60115-1 4.30	IPA for 5±0.5 Min. with ultrasonic	No deterioration of coatings and markings
Robustness of Terminations	IEC 60115-1 4.16	Direct load for 10 Sec. in the direction of the terminal leads	≥2.5kg (24.5N)
Periodic-pulse Overload	IEC 60115-1 4.39	4 times RCWV 10,000 cycles (1 Sec. on, 25 Sec. off)	±2.0%+0.05 Ω
Damp Heat Steady State	IEC 60115-1 4.24	40±2°C, 90-95% RH for 56 days, loaded with 0.1 times RCWV	±5.0%+0.05 Ω
Endurance at 70°C	IEC 60115-1 4.25	70±2°C at RCWV for 1,000 Hr. (1.5 Hr. on, 0.5 Hr. off)	±5.0%+0.05 Ω
Temperature Cycling	IEC 60115-1 4.19	-55°C ⇄ Room Temp. ⇄ +155°C ⇄ Room Temp. (5 cycles)	±2.0%+0.05 Ω
Resistance to Soldering Heat	IEC 60115-1 4.18	260±3°C for 10±1 Sec., immersed to a point 3±0.5mm from the body	±1.0%+0.05 Ω

Note: Rated Continuous Working Voltage (RCWV) = $\sqrt{\text{Power Rating} \times \text{Resistance Value}}$

Cement Resistors

Radial Terminals Type

Normal Style [SQZ Series]

Non-Inductive Style [NSZ Series]



INTRODUCTION

The materials used and the construction techniques ensure excellent flame resistance, arc resistance and moisture resistance as well as self-extinguishing capabilities. They will withstand the most rigorous loading test.

As resistors in radio and television receivers, hazardous conditions such as smoking and redheat can be completely prevented by the proper choice of power resistors.

FEATURES

Power Rating	3W, 5W, 7W, 10W, 15W, 20W
Resistance Tolerance	±5%
T.C.R.	±300ppm/°C

DERATING CURVE

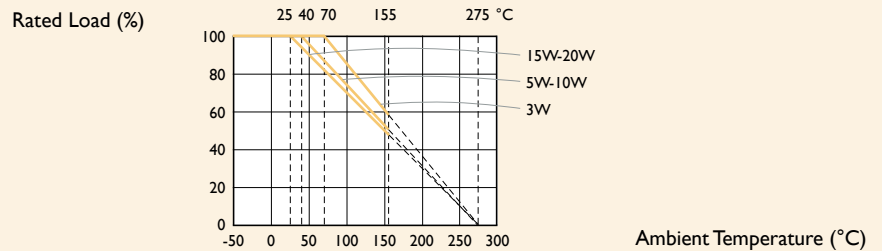

TEMPERATURE RISE

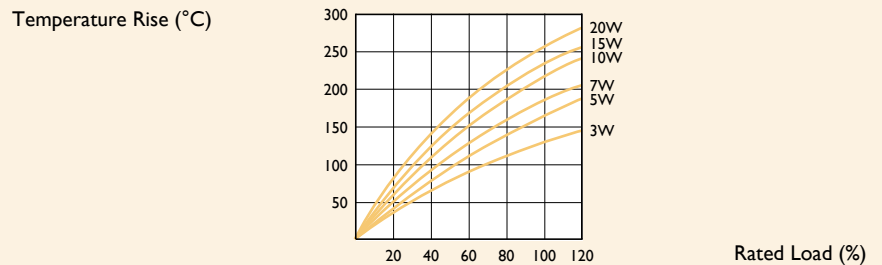

DIMENSIONS

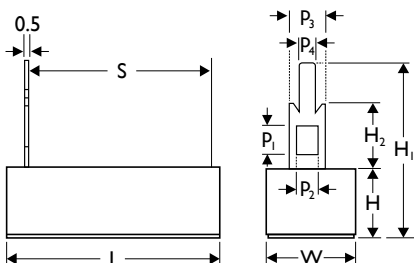

Unit: mm

STYLE	DIMENSION	DIMENSION											
		Normal	Non-Ind.	L	H	W	S	H ₁	H ₂	P ₁	P ₂	P ₃	P ₄
SQZ300	NSZ300			24.0±1.5	9.0±1	9.0±1	10.0±1	24.0±1	9.5±1.0	4.0±0.2	2.0±0.2	5.0±0.2	1.4±0.1
SQZ500	NSZ500			27.0±1.5	9.5±1	9.5±1	15.0±1	24.0±1	9.5±1.0	4.0±0.2	2.0±0.2	5.0±0.2	1.4±0.1
SQZ700	NSZ700			35.0±1.5	9.5±1	9.5±1	22.5±1	24.0±1	9.5±1.0	4.0±0.2	2.0±0.2	5.0±0.2	1.4±0.1
SQZ10A	NSZ10A			48.0±1.5	9.5±1	9.5±1	32.5±1	24.0±1	9.5±1.0	4.0±0.2	2.0±0.2	5.0±0.2	1.4±0.1
SQZ15A	NSZ15A			48.0±1.5	12.5±1	12.5±1	32.5±1	34.5±1	15.0±1.5	7.0±0.2	6.0±0.2	10.0±0.2	2.7±0.1
SQZ20A	NSZ20A			63.5±2.0	12.5±1	12.5±1	42.5±1	34.5±1	15.0±1.5	7.0±0.2	6.0±0.2	10.0±0.2	2.7±0.1

ELECTRICAL CHARACTERISTICS

NORMAL STYLE

STYLE	SQZ300	SQZ500	SQZ700	SQZ10A	SQZ15A	SQZ20A
Power Rating at 25°C					15W	20W
Power Rating at 40°C		5W	7W	10W		
Power Rating at 70°C	3W					
Maximum Working Voltage	250V	350V	500V			
Maximum Overload Voltage	500V	700V	1,000V			
Voltage Proof	500V	700V	1,000V			
Resistance Range (Wirewound)	0.3 Ω - 130 Ω	0.36 Ω - 200 Ω		0.56 Ω - 430 Ω	1 Ω - 560 Ω	1.5 Ω - 750 Ω
Resistance Range (Metal Oxide Film)	150 Ω - 1M Ω	220 Ω - 1M Ω	300 Ω - 1M Ω	470 Ω - 1M Ω	750 Ω - 1M Ω	820 Ω - 1M Ω
Operating Temp. Range	-55°C to +155°C					
Temperature Coefficient	±300ppm/°C					

NON-INDUCTIVE STYLE

STYLE	NSZ300	NSZ500	NSZ700	NSZ10A	NSZ15A	NSZ20A
Power Rating at 25°C					15W	20W
Power Rating at 40°C		5W	7W	10W		
Power Rating at 70°C	3W					
Maximum Working Voltage	250V	350V	500V			
Maximum Overload Voltage	500V	700V	1,000V			
Voltage Proof	500V	700V	1,000V			
Resistance Range (Wirewound)	0.1 Ω - 10 Ω			0.1 Ω - 20 Ω		0.1 Ω - 30 Ω
Operating Temp. Range	-55°C to +155°C					
Temperature Coefficient	±300ppm/°C					

Note: Special value is available on request

ENVIRONMENTAL CHARACTERISTICS

PERFORMANCE TEST	TEST METHOD		APPRAISE
Short Time Overload	IEC 60115-1 4.13	2.5 times RCWV for 5 Sec.	±2.0%+0.05 Ω
Voltage Proof	IEC 60115-1 4.7	in V-block for 60 Sec., test voltage by type	By type
Temperature Coefficient	IEC 60115-1 4.8	-55°C to +155°C	By type
Insulation Resistance	IEC 60115-1 4.6	in V-block for 60 Sec.	>1,000M Ω
Solderability	IEC 60115-1 4.17	235±5°C for 3±0.5 Sec.	95% Min. coverage
Solvent Resistance of Marking	IEC 60115-1 4.30	IPA for 5±0.5 Min. with ultrasonic	No deterioration of coatings and markings
Robustness of Terminations	IEC 60115-1 4.16	Direct load for 10 Sec. in the direction of the terminal leads	≥2.5kg (24.5N)
Periodic-pulse Overload	IEC 60115-1 4.39	4 times RCWV 10,000 cycles (1 Sec. on, 25 Sec. off)	±2.0%+0.05 Ω
Damp Heat Steady State	IEC 60115-1 4.24	40±2°C, 90-95% RH for 56 days, loaded with 0.1 times RCWV	±5.0%+0.05 Ω
Endurance at 70°C	IEC 60115-1 4.25	70±2°C at RCWV for 1,000 Hr. (1.5 Hr. on, 0.5 Hr. off)	±5.0%+0.05 Ω
Temperature Cycling	IEC 60115-1 4.19	-55°C ⇄ Room Temp. ⇄ +155°C ⇄ Room Temp. (5 cycles)	±2.0%+0.05 Ω
Resistance to Soldering Heat	IEC 60115-1 4.18	260±3°C for 10±1 Sec., immersed to a point 3±0.5mm from the body	±1.0%+0.05 Ω

Note: Rated Continuous Working Voltage (RCWV) = $\sqrt{\text{Power Rating} \times \text{Resistance Value}}$

Cement Resistors

Power Wirewound & Axial Lead Type

Normal & Miniature Style [PSP Series]

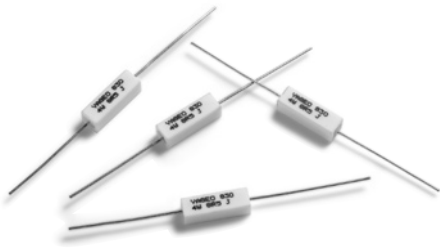

INTRODUCTION

The materials used and the construction techniques ensure excellent flame resistance, arc resistance and moisture resistance as well as self-extinguishing capabilities. They will withstand the most rigorous loading test.

As resistors in radio and television receivers, hazardous conditions such as smoking and redheat can be completely prevented by the proper choice of power resistors.

FEATURES

Power Rating	4W, 5W, 7W, 9W
Resistance Tolerance	±5%, ±10%
T.C.R.	±400ppm/°C

DERATING CURVE

For resistors operated in ambient temperatures above 70°C, power rating must be derated in accordance with the curve below.

Rated Load (%)

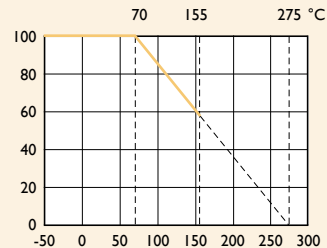

Ambient Temperature (°C)

DIMENSIONS

Unit: mm

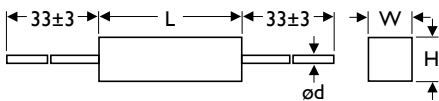

STYLE

DIMENSION

Normal	Miniature	L	W	H	ød
PSP400	-	20±1.0	6.4±0.3	6.4±0.3	0.8±0.02
PSP500	-	25±1.0	6.4±0.3	6.4±0.3	0.8±0.02
-	PSP7WS	25±1.0	9.0±0.3	9.0±0.3	0.8±0.02
PSP700	-	38±1.0	6.4±0.3	6.4±0.3	0.8±0.02
PSP900	-	38±1.0	9.0±0.3	9.0±0.3	0.8±0.02

Note:

ELECTRICAL CHARACTERISTICS

STYLE	PSP400	PSP500	PSP7WS	PSP700	PSP900
Power Rating at 70°C	4W	5W	7W		9W
Resistance Range	0.1 Ω - 2.2K Ω		0.1 Ω - 2.5K Ω	0.5 Ω - 3.9K Ω	
Operating Temp. Range	-55°C to +155°C				
Temperature Coefficient	±400ppm/°C				

Note: Special value is available on request

ENVIRONMENTAL CHARACTERISTICS

PERFORMANCE TEST	TEST METHOD		APPRAISE
Short Time Overload	IEC 60115-1 4.13	2.5 times RCWV for 5 Sec.	±2.0%+0.05 Ω
Voltage Proof	IEC 60115-1 4.7	in V-block for 60 Sec., test voltage by type	By type
Temperature Coefficient	IEC 60115-1 4.8	-55°C to +155°C	By type
Insulation Resistance	IEC 60115-1 4.6	in V-block for 60 Sec.	>1,000M Ω
Solderability	IEC 60115-1 4.17	235±5°C for 3±0.5 Sec.	95% Min. coverage
Solvent Resistance of Marking	IEC 60115-1 4.30	IPA for 5±0.5 Min. with ultrasonic	No deterioration of coatings and markings
Robustness of Terminations	IEC 60115-1 4.16	Direct load for 10 Sec. in the direction of the terminal leads	≥2.5kg (24.5N)
Periodic-pulse Overload	IEC 60115-1 4.39	4 times RCWV 10,000 cycles (1 Sec. on, 25 Sec. off)	±2.0%+0.05 Ω
Damp Heat Steady State	IEC 60115-1 4.24	40±2°C, 90-95% RH for 56 days, loaded with 0.1 times RCWV	±5.0%+0.05 Ω
Endurance at 70°C	IEC 60115-1 4.25	70±2°C at RCWV for 1,000 Hr. (1.5 Hr. on, 0.5 Hr. off)	±5.0%+0.05 Ω
Temperature Cycling	IEC 60115-1 4.19	-55°C ⇄ Room Temp. ⇄ +155°C ⇄ Room Temp. (5 cycles)	±2.0%+0.05 Ω
Resistance to Soldering Heat	IEC 60115-1 4.18	260±3°C for 10±1 Sec., immersed to a point 3±0.5mm from the body	±1.0%+0.05 Ω

Note: Rated Continuous Working Voltage (RCWV) = $\sqrt{\text{Power Rating} \times \text{Resistance Value}}$

Cement Resistors

Power Wirewound & Vertical Lead Type

Normal & Miniature Style [PSM Series]

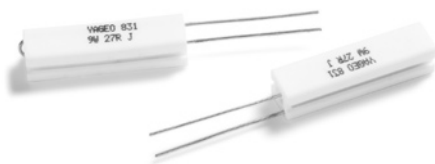

INTRODUCTION

The materials used and the construction techniques ensure excellent flame resistance, arc resistance and moisture resistance as well as self-extinguishing capabilities. They will withstand the most rigorous loading test.

As resistors in radio and television receivers, hazardous conditions such as smoking and redheat can be completely prevented by the proper choice of power resistors.

FEATURES

Power Rating	4W, 5W, 7W, 9W
Resistance Tolerance	±5%, ±10%
T.C.R.	±400ppm/°C

DERATING CURVE

For resistors operated in ambient temperatures above 70°C, power rating must be derated in accordance with the curve below.

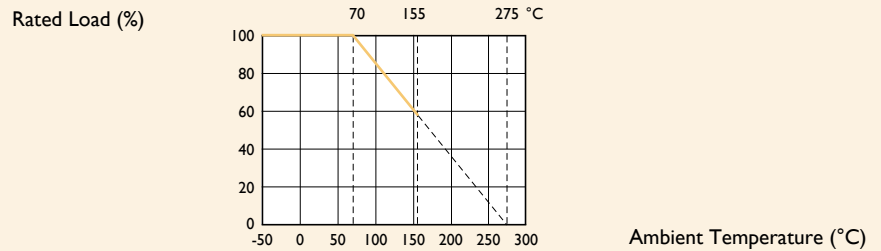

DIMENSIONS

Unit: mm

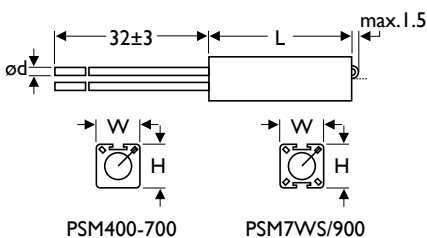

STYLE		DIMENSION			
Normal	Miniature	L	W	H	ød
PSM400	-	20±1.0	7.0±0.5	8.0±0.4	0.8±0.02
PSM500	-	25±1.0	7.0±0.5	8.0±0.4	0.8±0.02
-	PSM7WS	25±1.0	9.0±0.4	10.0±0.4	0.8±0.02
PSM700	-	38±1.0	7.0±0.5	8.0±0.4	0.8±0.02
PSM900	-	38±1.0	10.0±0.4	10.0±0.4	0.8±0.02

Note:

ELECTRICAL CHARACTERISTICS

STYLE	PSM400	PSM500	PSM7WS	PSM700	PSM900
Power Rating at 70°C	4W	5W	7W		9W
Resistance Range	0.1 Ω - 2.2K Ω		0.1 Ω - 2.5K Ω	0.5 Ω - 3.9K Ω	
Operating Temp. Range	-55°C to +155°C				
Temperature Coefficient	±400ppm/°C				

Note: Special value is available on request

ENVIRONMENTAL CHARACTERISTICS

PERFORMANCE TEST	TEST METHOD		APPRAISE
Short Time Overload	IEC 60115-1 4.13	2.5 times RCWV for 5 Sec.	±2.0%+0.05 Ω
Voltage Proof	IEC 60115-1 4.7	in V-block for 60 Sec., test voltage by type	By type
Temperature Coefficient	IEC 60115-1 4.8	-55°C to +155°C	By type
Insulation Resistance	IEC 60115-1 4.6	in V-block for 60 Sec.	>1,000M Ω
Solderability	IEC 60115-1 4.17	235±5°C for 3±0.5 Sec.	95% Min. coverage
Solvent Resistance of Marking	IEC 60115-1 4.30	IPA for 5±0.5 Min. with ultrasonic	No deterioration of coatings and markings
Robustness of Terminations	IEC 60115-1 4.16	Direct load for 10 Sec. in the direction of the terminal leads	≥2.5kg (24.5N)
Periodic-pulse Overload	IEC 60115-1 4.39	4 times RCWV 10,000 cycles (1 Sec. on, 25 Sec. off)	±2.0%+0.05 Ω
Damp Heat Steady State	IEC 60115-1 4.24	40±2°C, 90-95% RH for 56 days, loaded with 0.1 times RCWV	±5.0%+0.05 Ω
Endurance at 70°C	IEC 60115-1 4.25	70±2°C at RCWV for 1,000 Hr. (1.5 Hr. on, 0.5 Hr. off)	±5.0%+0.05 Ω
Temperature Cycling	IEC 60115-1 4.19	-55°C ⇄ Room Temp. ⇄ +155°C ⇄ Room Temp. (5 cycles)	±2.0%+0.05 Ω
Resistance to Soldering Heat	IEC 60115-1 4.18	260±3°C for 10±1 Sec., immersed to a point 3±0.5mm from the body	±1.0%+0.05 Ω

Note: Rated Continuous Working Voltage (RCWV) = $\sqrt{\text{Power Rating} \times \text{Resistance Value}}$

Cement Resistors

Fusible Thermal & Vertical Lead Type

Normal Style [FTR Series]

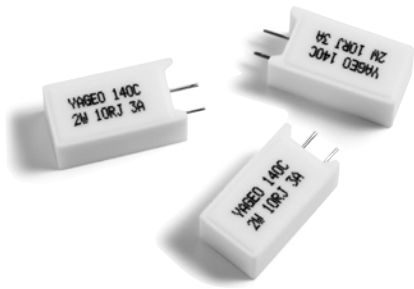

INTRODUCTION

The material used and the construction techniques ensure excellent flame resistance, arc resistance and moisture resistance as well as self-extinguishing capabilities. They will withstand the most rigorous loading test.

Apply fusible thermal resistors, respond quickly to overloading as external overheating. These resistors also provide outstanding feature against surges, suitable for the prevention of inrush current for switching regulators.

FEATURES

Rated Current	2A, 3A, 5A, 10A
Resistance Tolerance	±5%, ±10%
T.C.R.	±250ppm/°C

DIMENSIONS

Unit: mm

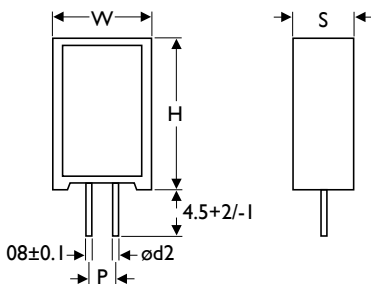

STYLE	DIMENSION				
	H	W	S	P	$\phi d2$
FTR100	25±1.5	13±1.0	9.0±1.0	5.0±1.0	0.6±0.1
FTR200	38±1.5	13±1.0	9.0±1.0	5.0±1.0	
FTR300	35±1.5	16±1.0	12±1.0	7.5±1.0	

Note:

ELECTRICAL CHARACTERISTICS

STYLE	STANDARD CURRENT (A)	FUSING TEMPERATURE (°C)	STANDARD VOLTAGE (V)	RESISTANCE RANGE	POWER RATING AT 70°C		
					FTR100	FTR200	FTR300
FTR100 / 200 / 300	10A	109+1/-3	250	1 Ω - 10K Ω	1.2	1.4	2.0
		129±4			1.6	2.0	2.5
		152±4			1.6	2.0	2.5
		188+3/-1			2.0	2.4	3.5
		226+1/-3			2.0	2.4	3.5
	5A	129±3			1.6	2.2	-
		187+1/-3			2.1	2.4	-
	3A	145±4			1.6	2.2	-
	2A	95+3/0			0.8	1.2	-
		110±4			1.2	1.4	-
		126±4			1.4	1.6	-
		130±4			1.6	2.1	-
		135±4			1.8	2.2	-
					145±4	2.1	2.4

Note: Special value is available on request

ENVIRONMENTAL CHARACTERISTICS

PERFORMANCE TEST	TEST METHOD		APPRAISE
Short Time Overload	IEC 60115-1 4.13	2.5 times RCWV for 5 Sec.	±2.0%+0.05 Ω
Temperature Coefficient	IEC 60115-1 4.8	-25°C to +125°C	By type
Robustness of Terminations	IEC 60115-1 4.16	Direct load for 10 Sec. In the direction of the terminal leads	≥25N
Damp Heat Steady State	IEC 60115-1 4.24	40±2°C, 90-95% RH for 56 days, loaded with 0.1 times RCWV	±5.0%+0.1 Ω

Note: Rated Continuous Working Voltage (RCWV) = $\sqrt{\text{Power Rating} \times \text{Resistance Value}}$

Cement Resistors

Low Ohmic Metal Plate Type Normal Style [SLR Series]



INTRODUCTION

The materials used and the construction techniques ensure excellent flame resistance, arc resistance and moisture resistance as well as self-extinguishing capabilities. They will withstand the most rigorous loading test.

As resistors in radio and television receivers, hazardous conditions such as smoking and redheat can be completely prevented by the proper choice of power resistors.

FEATURES

Power Rating	2W, 3W, 5W, 7W, 10W
Resistance Tolerance	±5%, ±10%
T.C.R.	±250ppm/°C

DERATING CURVE

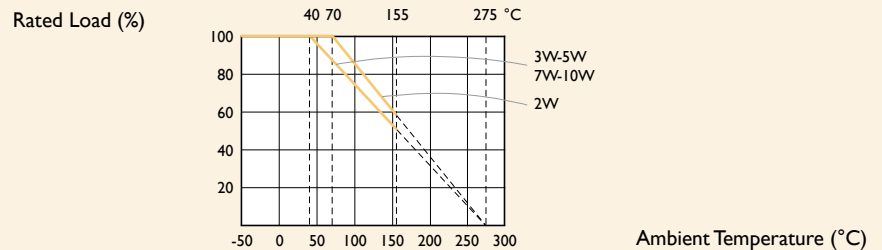

TEMPERATURE RISE

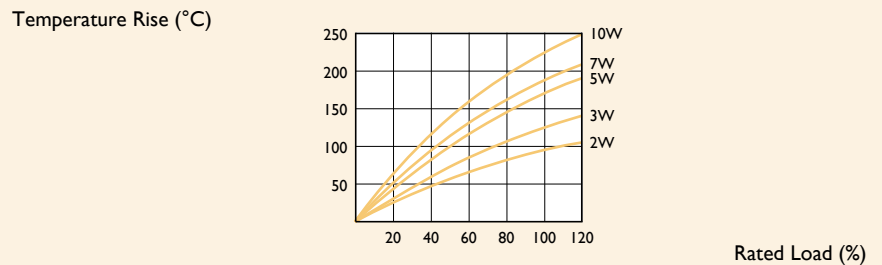

DIMENSIONS

Unit: mm

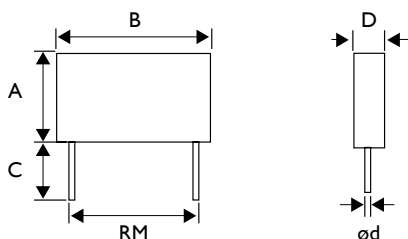

STYLE	DIMENSION					
	A	B	C	D	ød	RM
Normal						
SLR200	8±1	13±1	3.5±1	5±1	0.6±0.05	9±1
SLR300	13±1	13±1	3.5±1	5±1	0.6±0.05	8±1
SLR500	18±1	14±1	3.5±1	5±1	0.6±0.05	10±1
SLR700	18±1	26±1	3.5±1	5±1	0.8±0.05	20±1
SLR10A	20±1	26±1	3.5±1	5±1	0.8±0.05	20±1

Note:

ELECTRICAL CHARACTERISTICS

STYLE	SLR200	SLR300	SLR500	SLR700	SLR10A
Power Rating at 40°C		3W	5W	7W	10W
Power Rating at 70°C	2W				
Maximum Working Voltage	250V	350V		500V	
Maximum Overload Voltage	500V	700V		1,000V	
Dielectric Withstanding Voltage	500V	700V		1,000V	
Resistance range	0.10 Ω - 0.68 Ω	0.01 Ω - 1 Ω	0.01 Ω - 3.3 Ω		
Operating Temp. Range	-55°C to +155°C				
Temperature Coefficient	±250ppm/°C				

Note: Special value is available on request

ENVIRONMENTAL CHARACTERISTICS

PERFORMANCE TEST	TEST METHOD		APPRAISE
Short Time Overload	IEC 60115-1 4.13	2.5 times RCWV for 5 Sec.	±2.0%+0.05 Ω
Voltage Proof	IEC 60115-1 4.7	in V-block for 60 Sec., test voltage by type	By type
Temperature Coefficient	IEC 60115-1 4.8	-55°C to +155°C	By type
Insulation Resistance	IEC 60115-1 4.6	in V-block for 60 Sec.	>1,000M Ω
Solderability	IEC 60115-1 4.17	235±5°C for 3±0.5 Sec.	95% Min. coverage
Solvent Resistance of Marking	IEC 60115-1 4.30	IPA for 5±0.5 Min. with ultrasonic	No deterioration of coatings and markings
Robustness of Terminations	IEC 60115-1 4.16	Direct load for 10 Sec. in the direction of the terminal leads	≥2.5kg (24.5N)
Periodic-pulse Overload	IEC 60115-1 4.39	4 times RCWV 10,000 cycles (1 Sec. on, 25 Sec. off)	±2.0%+0.05 Ω
Damp Heat Steady State	IEC 60115-1 4.24	40±2°C, 90-95% RH for 56 days, loaded with 0.1 times RCWV	±5.0%+0.1 Ω
Endurance at 70°C	IEC 60115-1 4.25	70±2°C at RCWV for 1,000 Hr. (1.5 Hr. on, 0.5 Hr. off)	±5.0%+0.1 Ω
Temperature Cycling	IEC 60115-1 4.19	-55°C ⇄ Room Temp. ⇄ +155°C ⇄ Room Temp. (5 cycles)	±2.0%+0.05 Ω
Resistance to Soldering Heat	IEC 60115-1 4.18	260±3°C for 10±1 Sec., immersed to a point 3±0.5mm from the body	±1.0%+0.05 Ω

Note: Rated Continuous Working Voltage (RCWV) = $\sqrt{\text{Power Rating} \times \text{Resistance Value}}$

Aluminum Housed Resistors

Power Wirewound Type

Lug / Threaded Style [AHA Series]
Straight Leadwire Style [AHP Series]

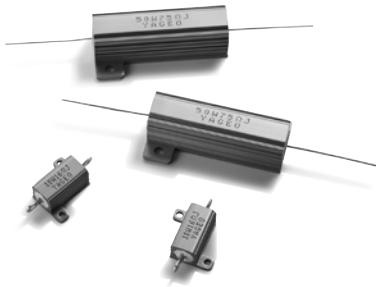

FEATURES

Power Rating	5W, 10W, 25W, 50W, 80W, 100W, 250W
Resistance Tolerance	±0.25%, ±0.5%, ±1%, ±5%, ±10%
T.C.R.	±200ppm/°C

DIMENSIONS

Unit: mm

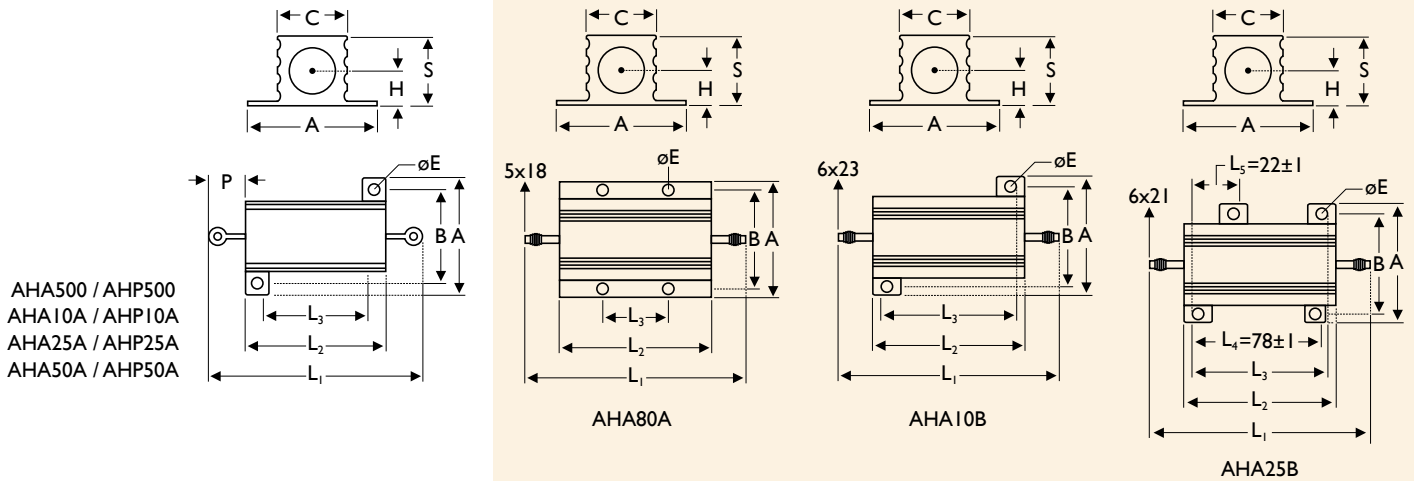

STYLE	DIMENSION									
	L ₁	L ₂	L ₃	A	B	C	øE	S	H	P
Normal										
AHA500 / AHP500	25±2	15±1	10±1	16.5±1	12.5±1	8.5±1	2±0.3	8±1	4±0.5	5±2
AHA10A / AHP10A	32±2	19±1	14±1	20±1	15.5±1	10.5±1	2±0.3	10±1	5±0.5	6±2
AHA25A / AHP25A	47±2	27±1	18±1	27±1	19±1	15±1	3.2±0.3	15.5±1	7±0.5	10±2
AHA50A / AHP50A	70±2	50±1	39±1	29±1	21±1	15±1	3.2±0.3	15.5±1	7±0.5	10±2
AHA80A	102±2	66±1	35±1	47±1	37±1	28±1	4.5±0.3	25±1	12±0.5	-
AHA10B	135±2	89±1	69±1	70±1	48±1	46±1	5±0.3	44.5±1	19.5±0.5	-
AHA25B	155±2	114±1	98±1	77±1	64±1	53±1	5±0.3	55.5±1	25±0.5	-

TEMPERATURE RISE

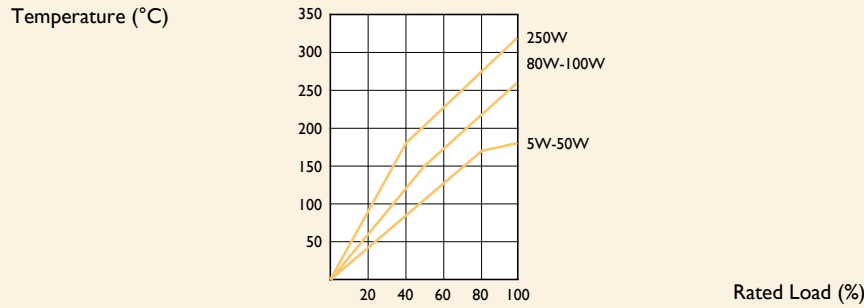

ELECTRICAL CHARACTERISTICS

STYLE	AHA500 AHP500	AHA10A AHP10A	AHA25A AHP25A	AHA50A AHP50A	AHA80A	AHA10B	AHA25B
Power Rating at 70°C	5W	10W	25W	50W	80W	100W	250W
Voltage Proof	1,000V			2,000V		4,500V	
Resistance Range	0.1 Ω - 100 Ω				0.1 Ω - 3K Ω		
Operating Temp. Range	-55°C to +250°C						
Temperature Coefficient	±200ppm/°C						

Note: Special value is available on request.

ENVIRONMENTAL CHARACTERISTICS

PERFORMANCE TEST	TEST METHOD		APPRAISE
Short Time Overload	IEC 60115-1 4.13	2.5 times RCWV for 5 Sec.	±0.5%+0.05 Ω
Voltage Proof	IEC 60115-1 4.7	in V-block for 60 Sec., test voltage by type	By type
Temperature Coefficient	IEC 60115-1 4.8	-55°C to +250°C	By type
Insulation Resistance	IEC 60115-1 4.6	in V-block for 60 Sec.	>100M Ω
Solderability	IEC 60115-1 4.17	235±5°C for 3±0.5 Sec.	95% Min. coverage
Solvent Resistance of Marking	IEC 60115-1 4.30	IPA for 5±0.5 Min. with ultrasonic	No deterioration of coatings and markings
Robustness of Terminations	IEC 60115-1 4.16	Pull test (30 Sec. Min): 5W: 1kg, 10W: 2.3kg, 25 - 50W: 4.5kg Torque test (5 - 15 Sec): 80W: 2N, 100W: 2.7N, 250W: 3.7N	±0.2%+0.05 Ω
Damp Heat Steady State	IEC 60115-1 4.24	40±2°C, 90-95% RH for 56 days, loaded with 0.1 times RCWV	±0.5%+0.05 Ω
Endurance at 70°C	IEC 60115-1 4.25	70±2°C at RCWV for 1,000 Hr. (1.5 Hr. on, 0.5 Hr. off)	±1.5%+0.05 Ω
Temperature Cycling	IEC 60115-1 4.19	-55°C ⇌ Room Temp. ⇌ +155°C ⇌ Room Temp. (5 cycles)	±1.0%+0.05 Ω
Resistance to Soldering Heat	IEC 60115-1 4.18	260±3°C for 10±1 Sec., immersed to a point 3±0.5mm from the body	±1.0%+0.05 Ω

Note: Rated Continuous Working Voltage (RCWV) = $\sqrt{\text{Power Rating} \times \text{Resistance Value}}$

GENERAL INFORMATION**PACKING METHODS**

The resistors are supplied on bandolier; either 1,000 resistors in ammpack or 5,000 resistors on reel.

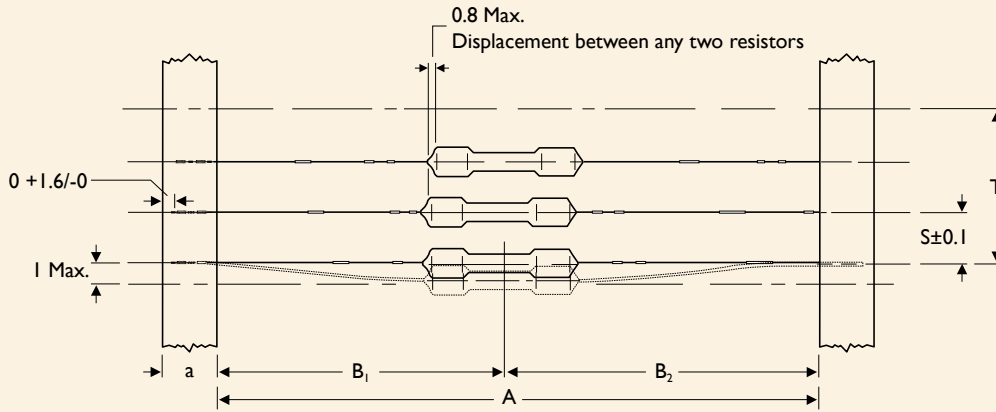

Bandolier for Axial Leads

STYLE		DIMENSIONS					Unit: mm
Normal	Miniature	a	A ⁽¹⁾	B ₁ - B ₂	S (Spacing)	T (Max. Deviation of Spacing)	
TYPE-12	TYPE25S / 204	6±0.5	52.4±1.5 26.0±1.5	1.2 1	5		
TYPE-25	TYPE50S / 207	6±0.5	52.4±1.5 26.0±1.5	1.2 1	5		
TYPE-50	TYPE1WS	6±0.5	52.4±1.5	1.2	5	1mm Per 10 Spacings, 0.5mm Per 5 Spacings	
TYPE100	TYPE2WS	6±0.5	73.0±1.5 52.4±1.5	1.5 1.2	5		
TYPE200	TYPE3WS	6±0.5	73.0±1.5	1.5	10		
KNP300	KNP5WS		52.4±1.5	1.2			
RSF300	RSF5WS	6±0.5	91.0±1.5	1.5	10		
RSF500 / KNP500	KNP7WS		73.0±1.5	1.5			

Note: 1. Optional please refer to table "Exception"

EXCEPTION

Unit: mm

SERIES	POWER RATING	STANDARD LEAD LENGTH	MINIATURE LEAD LENGTH
RSF	3WM, 5SS	73	52.4
KNP / NKN / FKN	3W, 4W, 5WS	73	
RSF / KNP / NKN / FKN	5W, 7W on T/R	73	52.4

TAPE ON REEL PACKING

Bandoliers can be reeled; dimension a differ with type.

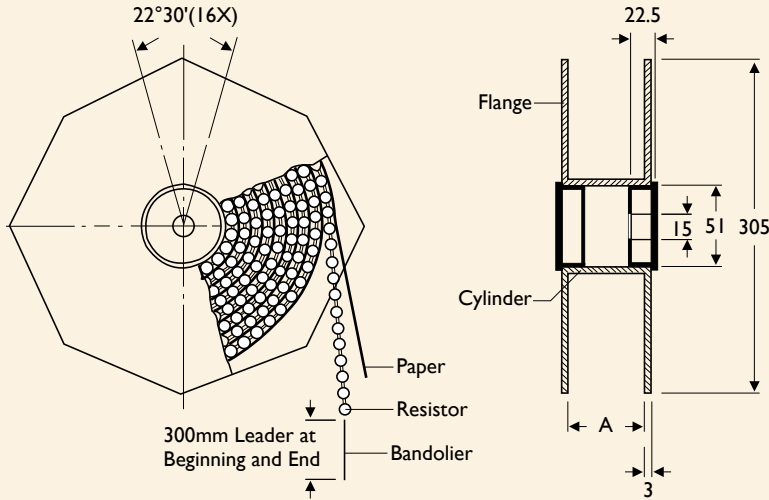

TAPE ON BOX PACKING

Bandoliers may also be supplied in a cardboard box ("ammopack").

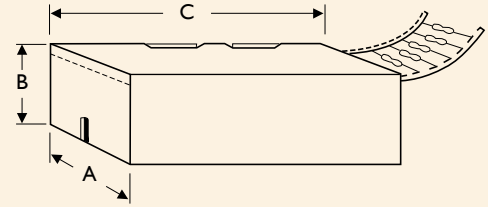

"Ammopack" is an abbreviation of "ammunition packing"
The dimensions of A-B-C vary with type and quantity.

STYLE		TAPE ON REEL		TAPE ON BOX			Unit: mm/pcs
Normal	Miniature	Across Flange (A)	Q'TY Per Reel	W (A)	H (B)	L (C)	Q'TY Per Box
TYPE-12	TYPE25S / 204	72	5,000	78/81	24/70	260	2,000/5,000
TYPE-25	TYPE50S / 207	48/72	5,000	78/81	24/104	260	1,000/5,000
TYPE-50	TYPE1WS	72	2,500	73	45	258	1,000
TYPE100	TYPE2WS	95	2,000	103	78	260	1,000
TYPE200	TYPE3WS	95	1,000	103	94	260	1,000
KNP300	KNP5WS	95	1,000	103	78	260	500
RSF300	RSF5WS	95	250	116	79	255	250
RSF500 / KNP500	KNP7WS						

BULK PACKING

POWER RATING	PCS/PER INNER BOX	BAG/PER INNER BOX	PCS/PER BAG
1/6W, 1/4WS, 0.4W	10,000	10	1,000
1/4W, 1/2WS, 0.6W	10,000	10	1,000
1/2W, 1WS	5,000	5	1,000
1W, 2WS	2,000	4	500
2W, 3WS	1,000	2	500
3W	1,000	2	500
5W	500	10	50
7W	500	10	50

PACKING QUANTITIES

TYPE	POWER	PACKAGE	Q'TY	WEIGHT	CARTON Q'TY	NW	GW	CARTON SIZE	CUBIC FIT
(Unit)	(Watt)		(Pcs)	(Kg)	(Pcs)	(Kg)	(Kg)	(cm)	(Cu.ft.)
Coating Type	1/6W	Tape / Reel	5,000	1.1	50,000	11	13	60×30.5×43.5	3
	1/4WS	Tape / Box	5,000	0.74	100,000	15	16	42.5×28×35	1.5
	0.4W	Bulk	10,000	1.18	160,000	19	20	42.5×28×35	1.5
	1/4W	Tape / Reel	5,000	1.5	50,000	16	18	60×30.5×43.5	3
	1/2WS	Tape / Box	5,000	1.1	75,000	18	19	42.5×28×35	1.5
	0.6W	Bulk	10,000	1.6	80,000	12	13	42.5×28×35	1.5
	1/2W	Tape / Reel	2,500	1.1	25,000	11	13	60×30.5×43.5	3
	1WS	Tape / Box	1,000	0.43	30,000	13	14	40.5×28×33	1.4
	1SS	Bulk	5,000	1.86	40,000	14	15	42.5×28×35	1.5
	1W	Tape / Reel	2,000	2.2	20,000	22	24	60×30.5×43.5	3
	2WS	Tape / Box	1,000	0.9	20,000	17	18	42.5×28×35	1.5
	2SS	Bulk	2,000	1.4	32,000	22	23	42.5×28×35	1.5
	2W	Tape / Reel	1,000	1.6	10,000	13	14	60×30.5×43.5	3
	3WS	Tape / Box	1,000	1.12	12,000	14	15	42.5×28×35	1.5
	3WV	Bulk	1,000	1.02	16,000	22	24	42.5×28×35	1.5
	3W	Tape / Reel	250	1.4	2,000	11	13	60×30.5×43.5	3
	5WS	Tape / Box	250	1.02	4,000	16	17	42.5×28×35	1.5
		Bulk	500	1.85	4,000	14	15	42.5×28×35	1.5
	5W, 7WS	Tape / Box	250	1	4,000	16	17	42.5×28×35	1.5
	5SS	Tape / Reel	1,000	2.5	8,000	21	23	60×30.5×43.5	3
3WM	Tape / Box	500	0.93	8,000	15	16	42.5×28×35	1.5	
	Bulk	1,000	1.7	16,000	27	28	42.5×28×35	1.5	
Jumper Wire	JPW-05	Tape / Reel	10,000	1.4	100,000	15	17	60×30.5×43.5	3
		Tape / Box	10,000	1.06	150,000	16	17	42.5×28×35	1.5
		Bulk	10,000	0.98	160,000	16	17	42.5×28×35	1.5
	JPW-06	Tape / Reel	10,000	1.9	100,000	22	24	60×30.5×43.5	3
		Tape / Box	10,000	1.5	150,000	24	25	42.5×28×35	1.5
		Bulk	10,000	1.4	160,000	23	24	42.5×28×35	1.5
	JPW-07	Tape / Reel	10,000	3	100,000	32	34	60×30.5×43.5	3
	JPW-08	Tape / Box	5,000	2.7	100,000	27	28	42.5×28×35	1.5
		Bulk	10,000	2.5	160,000	40	41	42.5×28×35	1.5
	JPW-10	Tape / Reel	10,000	5	100,000	50	52	60×30.5×43.5	3
Tape / Box		5,000	2.33	75,000	35	36	42.5×28×35	1.5	
Bulk		10,000	4.7	160,000	75	76	42.5×28×35	1.5	

PACKING QUANTITIES

SERIES	POWER	PACKAGE	Q'TY	WEIGHT	CARTON Q'TY	NW	GW	CARTON SIZE	CUBIC FIT
(Unit)	(Watt)		(Pcs)	(Kg)	(Pcs)	(Kg)	(Kg)	(cm)	(Cu.ft.)
SQP / NSP	2W	Bulk	1,000	3.8	4,000	15	16	42.5×28×35	1.5
	3W	Bulk	1,000	4.6	2,000	9	10	42.5×28×35	1.5
	5W	Bulk	900	4.8	1,800	10	10.5	42.5×28×35	1.5
	7W	Bulk	500	4.5	2,000	18	19	42.5×28×35	1.5
	10W	Bulk	500	5.8	2,000	23	24	42.5×28×35	1.5
	15W	Bulk	50	1.1	1,000	20	21	42.5×28×35	1.5
	20W	Bulk	50	1.4	1,000	27	28	42.5×28×35	1.5
	25W	Bulk	50	1.5	250	7	8	42.5×28×35	1.5
	30W	Bulk	50	3.3	250	16	17	42.5×28×35	1.5
	40W	Bulk	50	3.9	250	19	20	42.5×28×35	1.5
SQM / NSM	2W	Bulk	1,500	8.3	3,000	16.5	18	42.5×28×35	1.5
	3W	Bulk	1,500	9.1	3,000	18	19	42.5×28×35	1.5
	5W	Bulk	1,000	6.6	2,000	13	14	42.5×28×35	1.5
	7W	Bulk	800	8.1	3,200	32	33	42.5×28×35	1.5
	10W	Bulk	500	8.6	2,000	34	35	42.5×28×35	1.5
	10WS	Bulk	90	1.5	2,700	42	43	42.5×28×35	1.5
SQZ / NSZ	3W	Bulk	150	0.9	2,400	14	15	42.5×28×35	1.5
	5W	Bulk	150	1.0	2,400	16	16.5	42.5×28×35	1.5
	7W	Bulk	150	1.6	2,400	24	25	42.5×28×35	1.5
	10W	Bulk	150	2.1	2,400	33	34	42.5×28×35	1.5
	15W	Bulk	50	1.1	800	17	18	42.5×28×35	1.5
	20W	Bulk	50	1.4	800	21	22	42.5×28×35	1.5
SLR	2W	Bulk	1,000	1.6	8,000	12	13	42.5×28×35	1.5
	3W	Bulk	1,000	2.2	8,000	17	18.3	42.5×28×35	1.5
	5W	Bulk	240	0.9	4,800	17	18	42.5×28×35	1.5



FORMING DIMENSION (SPECIAL TYPE)

M TYPE

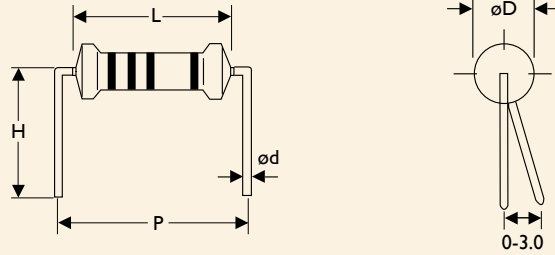

STYLE		DIMENSIONS					Unit: mm
Normal	Miniature	L	P	$\varnothing D$	$\varnothing d$	H	
TYPE-12	TYPE25S	3.4 ± 0.3	6.0 ± 1	1.9 ± 0.2	0.45 ± 0.05	10.0 ± 1	
TYPE-25	TYPE50S	6.3 ± 0.5	10.0 ± 1	2.4 ± 0.2	0.55 ± 0.05	10.0 ± 1	
TYPE-50	TYPE1WS	9.0 ± 0.5	12.5 ± 1	3.3 ± 0.3	0.55 ± 0.05	10.0 ± 1	
TYPE100	TYPE2WS	11.5 ± 1.0	15.0 ± 1	4.5 ± 0.5	0.8 ± 0.05	12.5 ± 1	
TYPE200	TYPE3WS	15.5 ± 1.0	20.0 ± 1	5.0 ± 0.5	0.8 ± 0.05	15.0 ± 1	

MB TYPE

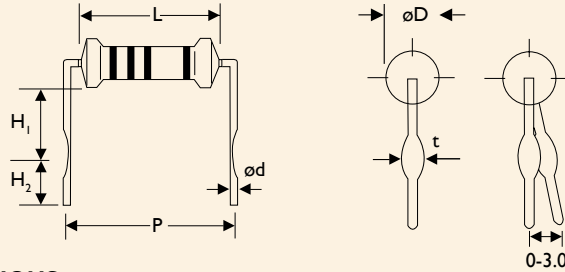

STYLE		DIMENSIONS							Unit: mm
Normal	Miniature	L	P	$\varnothing D$	$\varnothing d$	H_1	H_2	t	
TYPE-25	TYPE50S	6.3 ± 0.5	10.0 ± 1	2.4 ± 0.2	0.55 ± 0.05	6.0 ± 1	5.0 ± 1	1.2 ± 0.2	
TYPE-50	-	9.0 ± 0.5	12.5 ± 1	3.3 ± 0.3	0.55 ± 0.05	6.0 ± 1	5.0 ± 1	1.2 ± 0.2	
-	TYPE1WS	9.0 ± 0.5	12.5 ± 1	3.3 ± 0.3	0.8 ± 0.05	6.0 ± 1	5.0 ± 1	1.4 ± 0.2	
TYPE100	TYPE2WS	11.5 ± 1.0	15.0 ± 1	4.5 ± 0.5	0.8 ± 0.05	6.0 ± 1	5.0 ± 1	1.4 ± 0.2	
TYPE200	TYPE3WS	15.5 ± 1.0	20.0 ± 1	5.0 ± 0.5	0.8 ± 0.05	10.0 ± 1	5.0 ± 1	1.4 ± 0.2	
TYPE300	TYPE5WS	24.5 ± 1.0	30.0 ± 1	8.0 ± 0.5	0.8 ± 0.05	15.0 ± 1	5.0 ± 1	1.4 ± 0.2	
TYPE500	-	24.5 ± 1.0	30.0 ± 1	8.0 ± 0.5	0.8 ± 0.05	15.0 ± 1	5.0 ± 1	1.4 ± 0.2	

MR TYPE

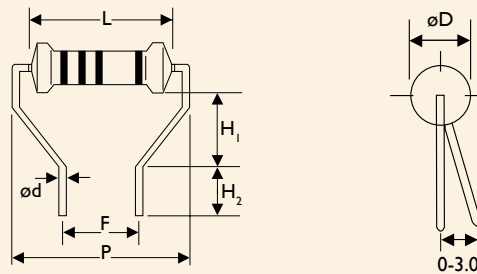

STYLE		DIMENSIONS							Unit: mm
Normal	Miniature	L	P	F	$\varnothing D$	$\varnothing d$	H_1	H_2	
TYPE-50	TYPE1WS	9.0 ± 0.5	14.5 ± 1	7.0 ± 0.5	3.3 ± 0.3	0.55 ± 0.05	7.0 ± 1	5.0 ± 1	
TYPE100	TYPE2WS	11.5 ± 1.0	17.5 ± 1	7.0 ± 0.5	4.5 ± 0.5	0.8 ± 0.05	8.0 ± 1	5.0 ± 1	
TYPE200	TYPE3WS	15.5 ± 1.0	21.5 ± 1	7.0 ± 0.5	5.0 ± 0.5	0.8 ± 0.05	9.0 ± 1	5.0 ± 1	

F TYPE

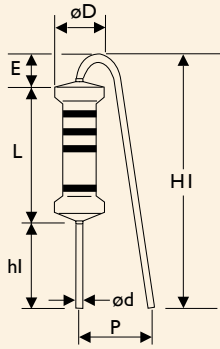

FK TYPE

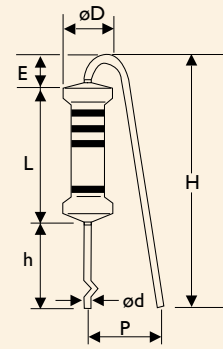

FFK TYPE

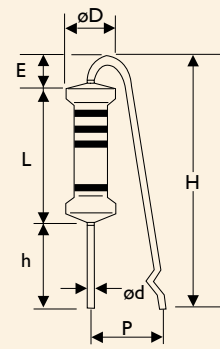

FFK TYPE

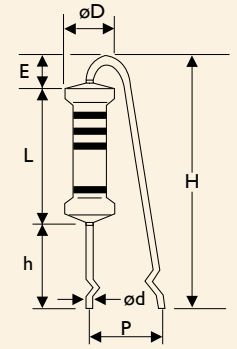

STYLE		DIMENSIONS								
Normal	Miniature	L	P	øD	ød	h	H Max.	hl	HI Max.	E Max.
TYPE100	TYPE2WS	11.5±1	6±1	4.5±0.5	0.8±0.05	10.0±1	25	5.0±1	20	3.5
TYPE200	TYPE3WS	15.5±1	6±1	5.0±0.5	0.8±0.05	10.0±1	30	5.0±1	25	3.5

Unit: mm

Note: TYPE-25/50S is available.

FT Type Forming for Taping

Rated Watts 1/4W, 1/2WS & 0.6W
 Body Dimension : L = 6.3±0.5mm
 øD = 2.4±0.2mm

Rated Watts : 1/2W & 1WS

Body Dimension : L = 9±0.5mm
 øD = 3.3±0.3mm

Rated Watts : 1W & 2WS

Body Dimension : L = 11.5±1.0mm
 øD = 4.5±0.5mm

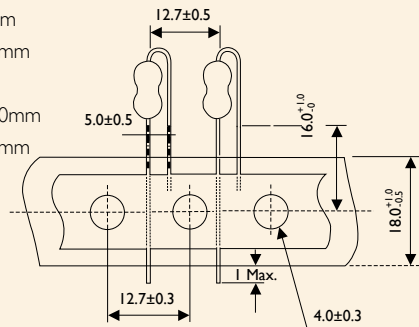

MT Type Forming for Taping

Rated Watts 1/6W, 1/4WS & 0.4W
 Body Dimension : L = 3.4±0.3mm
 øD = 1.9±0.2mm

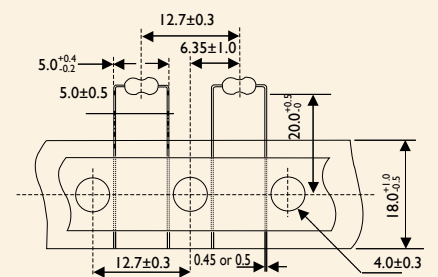

PN Type Forming for Taping

Rated Watts 1/4W, 1/2WS & 0.6W
 Body Dimension : L = 6.3±0.5mm
 øD = 2.4±0.2mm

Rated Watts : 1/2W & 1WS

Body Dimension : L = 9±0.5mm
 øD = 3.3±0.3mm

Rated Watts : 1W & 2WS

Body Dimension : L = 11.5±1.0mm
 øD = 4.5±0.5mm

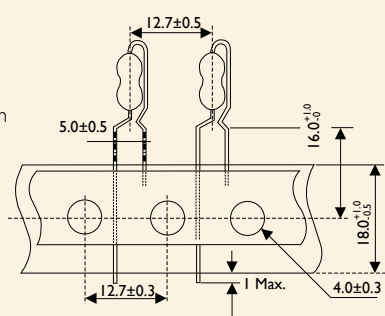

AV Type Forming for Taping

Rated Watts 1/4W, 1/2WS & 0.6W
 Body Dimension : L = 6.3±0.5mm
 øD = 2.4±0.2mm

Rated Watts : 1/2W & 1WS

Body Dimension : L = 9±0.5mm
 øD = 3.3±0.3mm

Rated Watts : 1W & 2WS

Body Dimension : L = 11.5±1.0mm
 øD = 4.5±0.5mm

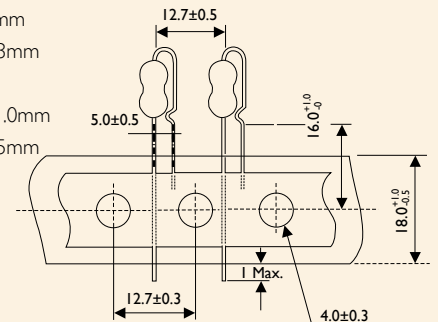



EXPLANATIONS OF ORDERING CODE

MFR	-12	F	T	F	52-	100R
Code 1 - 3 Series Name See Index	Code 4 - 6 Power Rating -05 = \varnothing d0.5mm -06 = \varnothing d0.6mm -07 = \varnothing d0.7mm -08 = \varnothing d0.8mm -10 = \varnothing d1.0mm -14 = \varnothing d1.4mm -12 = 1/6W -25 = 1/4W 25S = 1/4WS -50 = 1/2W 50S = 1/2WS 100 = 1W 1WS = 1WS 200 = 2W 2WS = 2WS 204 = 0.4W 207 = 0.6W 300 = 3W 3WS = 3WS 3WM = 3WM 400 = 4W 500 = 5W 5WS = 5WS 5SS = 5WSS 700 = 7W 7WS = 7WS 10A = 10W 20A = 20W 30A = 30W 40A = 40W 50A = 50W 10S = 10WS 15A = 15W 25A = 25W 10B = 100W 25B = 250W	Code 7 Tolerance P = ± 0.02 % A = ± 0.05 % B = ± 0.1 % C = ± 0.25 % D = ± 0.5 % F = ± 1 % G = ± 2 % J = ± 5 % K = ± 10 % - = Base on Spec.	Code 8 Packing Style T = Tape/Box R = Tape/Reel B = Bulk	Code 9 Temperature Coefficient of Resistance - = Base on Spec. A = ± 5 ppm/ $^{\circ}$ C B = ± 10 ppm/ $^{\circ}$ C C = ± 15 ppm/ $^{\circ}$ C D = ± 25 ppm/ $^{\circ}$ C E = ± 50 ppm/ $^{\circ}$ C F = ± 100 ppm/ $^{\circ}$ C G = ± 200 ppm/ $^{\circ}$ C H = ± 250 ppm/ $^{\circ}$ C I = ± 300 ppm/ $^{\circ}$ C J = ± 350 ppm/ $^{\circ}$ C	Code 10 - 12 Forming Type 26- = 26mm 52- = 52.4mm 73- = 73mm 81- = 81mm 91- = 91mm F = F Type FK = FK Type FKK = FKK Type FFK = F-form Kink M = M-Type Forming MB = M-form W/flat MT = MT Type Forming MR = MR Type AV = AVIsert PN = PANAsert	Code 13 - 17 Resistance Value 0R1 = 0.1 100R = 100 10K = 10,000 10M = 10,000,000

EXCEPTION:

• Cement series:

<Code 8>: Special packing style code

B: Bulk with wirewound or metal oxide sub-assembly for resistance value

W: Bulk with wirewound sub-assembly for resistance value

M: Bulk with metal oxide sub-assembly for resistance value

<Code 10-12>: Without forming code

Example: **SQP500JB-10R**

• JPW series:

<Code 13-17>: without resistance value code

Example: **JPW-06-T-52-**

Note:

A blank sheet of lined paper with horizontal ruling lines, set against a solid orange background. The paper has rounded corners and a white background. The lines are evenly spaced and extend across the width of the page. The word "Note:" is printed at the top left corner.

YAGEO - A GLOBAL COMPANY

ASIA

Beijing, China

Tel. +86 10 851 20810
Fax. +86 10 851 20200

Dongguan, China

Tel. +86 769 8772 0275
Fax. +86 769 8791 0053

Hong Kong, China

Tel. +852 2342 6833
Fax. +852 2342 6588

Mudu, China

Tel. +86 512 6651 8889
Fax. +86 512 6651 9889

Qingdao, China

Tel. +86 157 2525 4907
Fax. +86 512 6825 5568 x 2688

Suzhou, China

Tel. +86 512 6825 5568
Fax. +86 512 6825 5386

Wuhan, China

Tel. +86 27 5983 8939
Fax. +86 27 5983 8939

Saitama, Japan

Tel. +81 48 795 8953
Fax. +81 48 795 8954

Kyunggi-Do, Korea

Tel. +82 31 712 4797
Fax. +82 31 712 5866

Kuala Lumpur, Malaysia

Tel. +60 3 8063 8864
Fax. +60 3 8063 7376

Singapore

Tel. +65 6244 7800
Fax. +65 6244 4943

Taipei, Taiwan

Tel. +886 2 2917 7555
Fax. +886 2 2917 4286

EUROPE

Roermond, Benelux

Tel. +31 475 385 555
Fax. +31 475 385 589

Suresnes, France

Tel. +33 1 46 14 87 91
Fax. +33 1 46 14 87 92

Hamburg, Germany

Tel. +49 4121 870 189
Fax. +49 4121 870 271

Szombathely, Hungary

Tel. +36 30 3777 441
Fax. +36 94 517 701

Milan, Italy

Tel. +39 02 6129 1017
Fax. +39 02 6601 7490

Moscow, Russian Federation

Tel. +7 916 625 92 38
Fax. +7 498 610 07 07

Barcelona, Spain

Tel. +34 93 212 3929
Fax. +39 02 6601 7490

Berkshire, UK

Tel. +44 7767 346 607
Fax. +31 475 385 589

NORTH AMERICA

San Jose, U.S.A.

Tel. +1 408 240 6200
Fax. +1 408 240 6201

For more detailed and always up-to-date contact details of sales offices, distributors and representatives, please go to our website at

www.yageo.com

© YAGEO Corporation

All rights are reserved. Reproduction in whole or in part is prohibited without the prior written consent of the copyright owner.

The information presented in this document does not form part of any quotation or contract, is believed to be accurate and reliable and may be changed without notice.

No liability will be accepted by the publisher for any consequence of its use. Publication thereof does not convey nor imply any license under patent or other industrial or intellectual property rights.

X-ON Electronics

Largest Supplier of Electrical and Electronic Components

Click to view similar products for [Metal Film Resistors - Through Hole](#) category:

Click to view products by [Yageo](#) manufacturer:

Other Similar products are found below :

[MF2S-6K8JI](#) [GP55S-1002-FTW](#) [GP55S-1004-FTW](#) [GP55S-4753-FTW](#) [QW210](#) [RCFH-0.5-5TA](#) [RCFH-100-5TA](#) [RCFH-10-5TA](#) [RCFH-110-5TA](#) [RCFH-11K-5TA](#) [RCFH-11M-5TA](#) [RCFH-12K-5TA](#) [RCFH-130K-5TA](#) [RCFH-13-5TA](#) [RCFH-13K-5TA](#) [RCFH-13M-5TA](#) [RCFH-150K-5TA](#) [RCFH-15-5TA](#) [RCFH-160-5TA](#) [RCFH-160K-5TA](#) [RCFH-16-5TA](#) [RCFH-180K-5TA](#) [RCFH-18K-5TA](#) [RCFH-1M-5TA](#) [RCFH-200-5TA](#) [RCFH-200K-5TA](#) [RCFH-20K-5TA](#) [RCFH-220-5TA](#) [RCFH-220K-5TA](#) [RCFH-22K-5TA](#) [RCFH-2.2M-5TA](#) [RCFH-240K-5TA](#) [RCFH-24K-5TA](#) [RCFH-2-5TA](#) [RCFH-27-5TA](#) [RCFH-27K-5TA](#) [RCFH-2M-5TA](#) [RCFH-330-5TA](#) [RCFH-33-5TA](#) [RCFH-3.3M-5TA](#) [RCFH-360-5TA](#) [RCFH-360K-5TA](#) [RCFH-3.6M-5TA](#) [RCFH-39-5TA](#) [RCFH-39K-5TA](#) [RCFH-3.9M-5TA](#) [RCFH-430-5TA](#) [RCFH-47K-5TA](#) [RCFH-510K-5TA](#) [RCFH-51-5TA](#)