

DATA SHEET

METAL LOW OHMIC JUMPER

PA series

sizes 0201/ 0402/ 0603/ 0805

RoHS compliant & Halogen free



SCOPE

This specification describes PA0201/0402/0603/0805 series current sensor - low TCR with metal alloy layer.

APPLICATIONS

- Consumer goods
- Computer
- Telecom / Datacom
- Industrial / Power supply
- Alternative Energy
- Car electronics

FEATURES

- AEC-Q200 qualified
- Halogen-free Epoxy
- RoHS compliant
- Reduce environmentally hazardous wastes
- High component and equipment reliability
- Non-forbidden materials used in products/production
- Low resistances applied to current sensing
- Moisture sensitivity level: MSL 1

ORDERING INFORMATION - GLOBAL PART NUMBER

Global part numbers are identified by the series, size, tolerance, packing type, temperature coefficient, taping reel and resistance value.

GLOBAL PART NUMBER

PA XXXX X X X XX XXXX L
 (1) (2) (3) (4) (5) (6) (7)

(1) SIZE

0201 / 0402 / 0603 / 0805

(2) TOLERANCE

-

(3) PACKAGING TYPE

R = Paper taping reel

(4) TEMPERATURE COEFFICIENT OF RESISTANCE

-

(5) TAPING REEL

07 = 7 inch dia. Reel
 7W = 7 inch dia. Reel, (0402 only)
 47 = 7 inch dia. Reel, (0805 only)

(6) RESISTANCE VALUE

0 Ω

(7) DEFAULT CODE

Letter L is the system default code for ordering only. ^(Note)

Resistance rule of global part number

Resistance code rule	Example
0R (0 Ω)	0R = 0 Ω

ORDERING EXAMPLE

The ordering code for a PA0603 chip resistor, value 0 Ω, supplied in 7-inch tape reel with 5Kpcs quantify is: PA0603-R-070RL.

NOTE

1. All our RChip products are RoHS compliant. "LFP" of the internal 2D reel label mentions "Lead-Free Process"

MARKING

PA0201

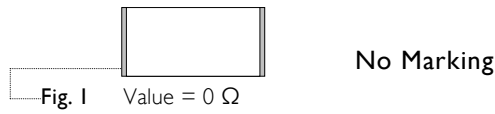

PA0402 / 0603 / 0805



CONSTRUCTION

The resistors are constructed using outstanding TCR level material, which makes Yageo PA resistors excellent for current sensing application in battery charger circuit & DC-DC converter.

The composition of the resistive material is adjusted to give the approximate required resistance and is covered with a protective coating. Marking is printed on the top side of the resistor.

Finally, the three external terminations (Cu / Ni / matte Tin) are added, as shown in Fig. 3.

Outlines

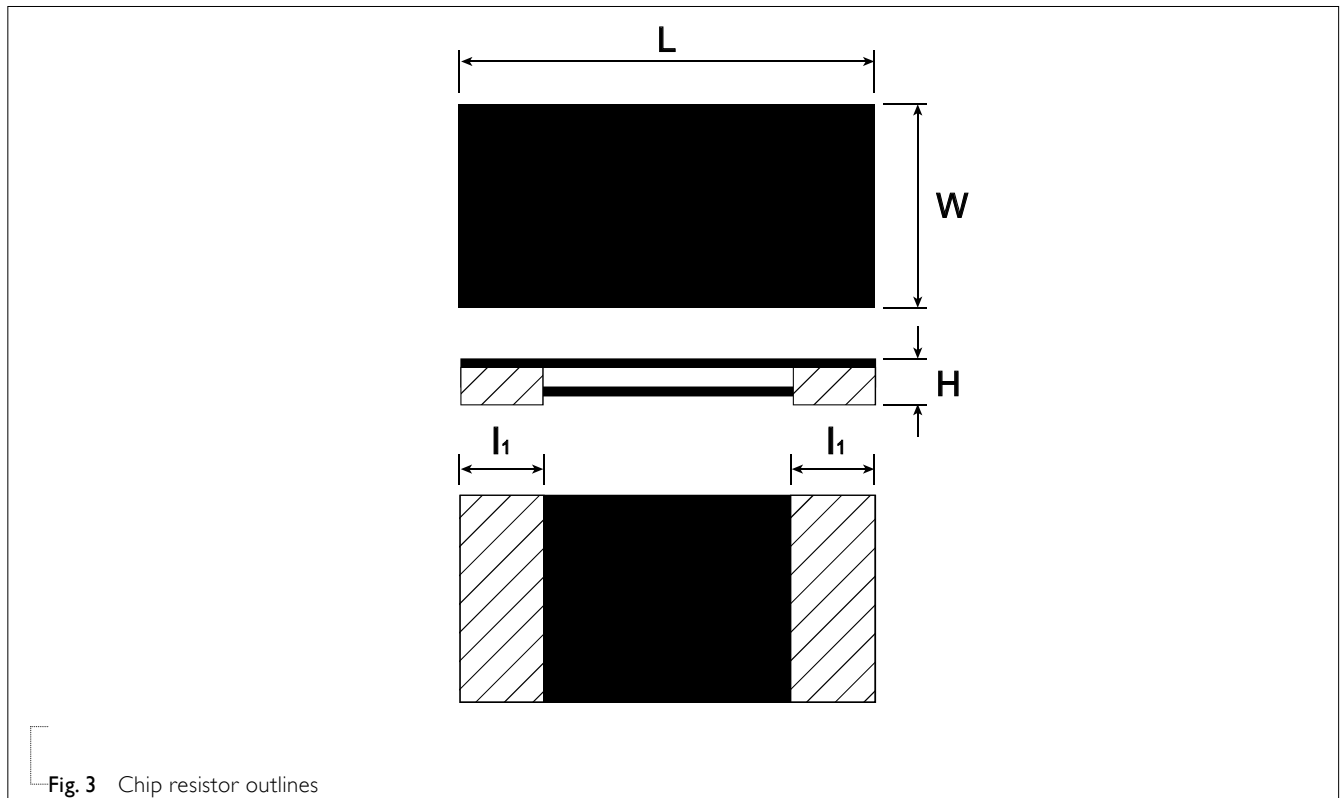

Fig. 3 Chip resistor outlines

DIMENSION

Table 1 For outlines, please refer to Fig. 4

TYPE	L (mm)	W (mm)	H (mm)	l ₁ (mm)
PA0201	0.60±0.03	0.31±0.04	Max. 0.35	0.15±0.06
PA0402	1.00±0.10	0.55±0.10	Max. 0.35	0.25±0.10
PA0603	1.60±0.20	0.8+0.10/-0.20	0.45±0.15	0.38±0.12
PA0805	2.00±0.15	1.20±0.15	Max. 0.40	0.35±0.25

Note:

1. For relevant physical dimensions, please refer to construction outlines.
2. Please contact with sales offices, distributors and representatives in your region before ordering.

ELECTRICAL CHARACTERISTICS

Table 2

		PA0201	PA0402		PA0603	PA0805
Jumper Criteria	Maximum Resistance	<5mΩ	<1mΩ	<0.5mΩ	<0.2mΩ	<0.2mΩ
	Maximum Current	4.5A	11A	20A	23A	50A
Operating Temperature Range		-55°C to +125°C			-55°C to +155°C	

Note: Please contact with sales offices, distributors and representatives in your region before ordering.

FUNCTIONAL DESCRIPTION

OPERATING TEMPERATURE RANGE

PA0201/ PA0402:-55°C to +125°C

PA0603/ PA0805:-55°C to +155°C

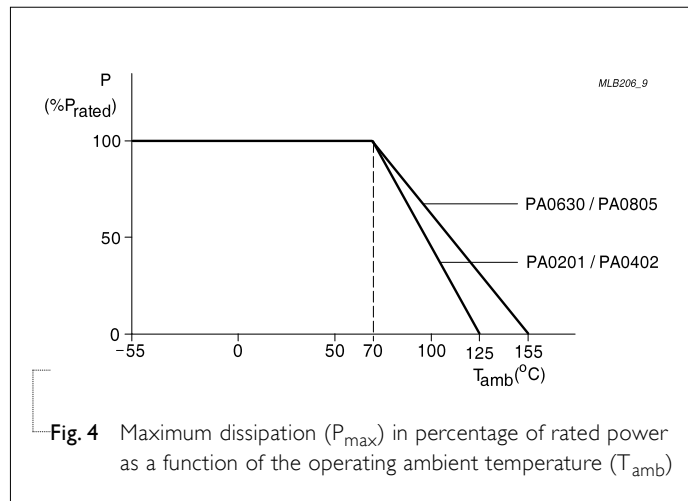

Fig. 4 Maximum dissipation (P_{max}) in percentage of rated power as a function of the operating ambient temperature (T_{amb})

PACKING STYLE AND PACKAGING QUANTITY

Table 3 Packing style and packaging quantity

PACKING STYLE	REEL DIMENSION	PA0201	PA0402	PA0603	PA0805
Paper taping reel (R)	7" (178 mm)	10,000	10,000	5,000	5,000

PAPER TAPE

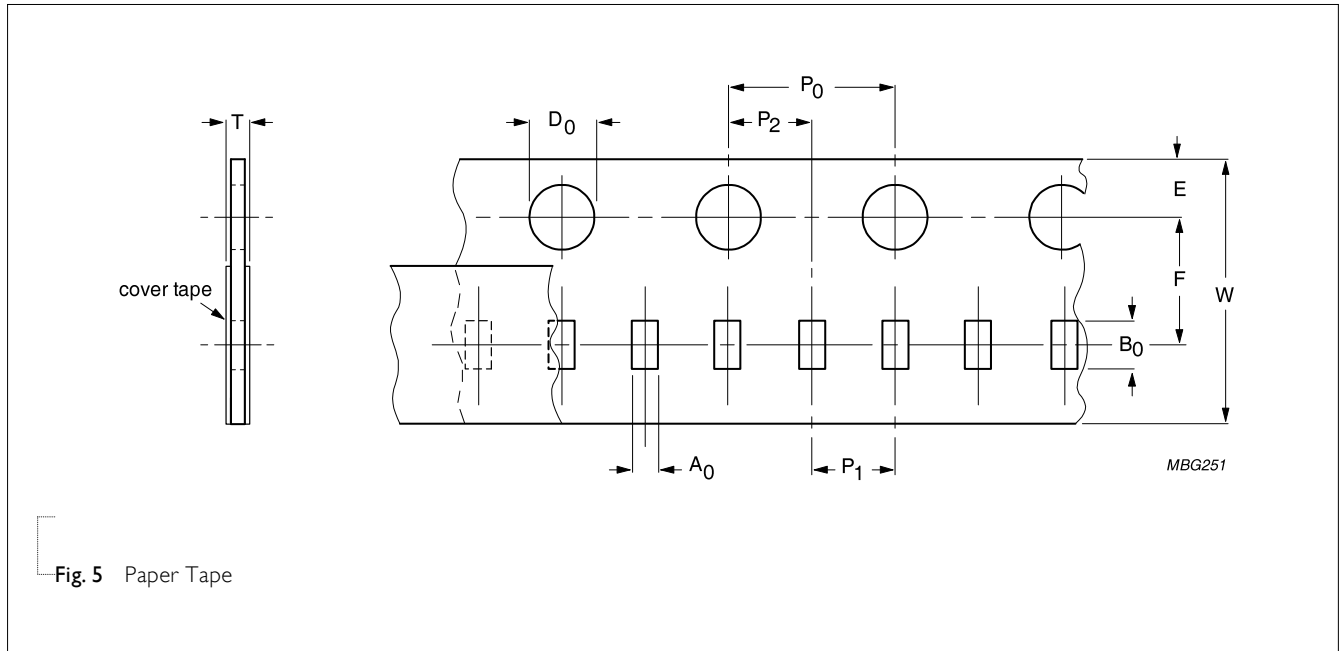

Fig. 5 Paper Tape

Table 4 Dimensions of paper tape for relevant chip resistors size

SIZE	SYMBOL											Unit: mm
	A ₀	B ₀	W	E	F	P ₀	P ₁	P ₂	ØD ₀	ØD ₁	T	
PA0201	0.38±0.10	0.68±0.10	8.00±0.10	1.75±0.10	3.50±0.10	4.00±0.10	2.00±0.10	2.00±0.10	1.55±0.05	1.50±0.10	0.42±0.10	
PA0402	0.59±0.10	1.20±0.10	8.00±0.10	1.75±0.10	3.50±0.10	4.00±0.10	2.00±0.10	2.00±0.10	1.55±0.05	1.50±0.10	0.45±0.10	
PA0603	1.10±0.10	1.90±0.10	8.00±0.10	1.75±0.10	3.50±0.10	4.00±0.10	4.00±0.10	2.00±0.10	1.55±0.05	1.50±0.10	0.43±0.10	
PA0805	1.62±0.10	2.35±0.10	8.00±0.10	1.75±0.10	3.50±0.10	4.00±0.10	4.00±0.10	2.00±0.10	1.55±0.05	1.50±0.10	0.43±0.10	

REEL SPECIFICATION

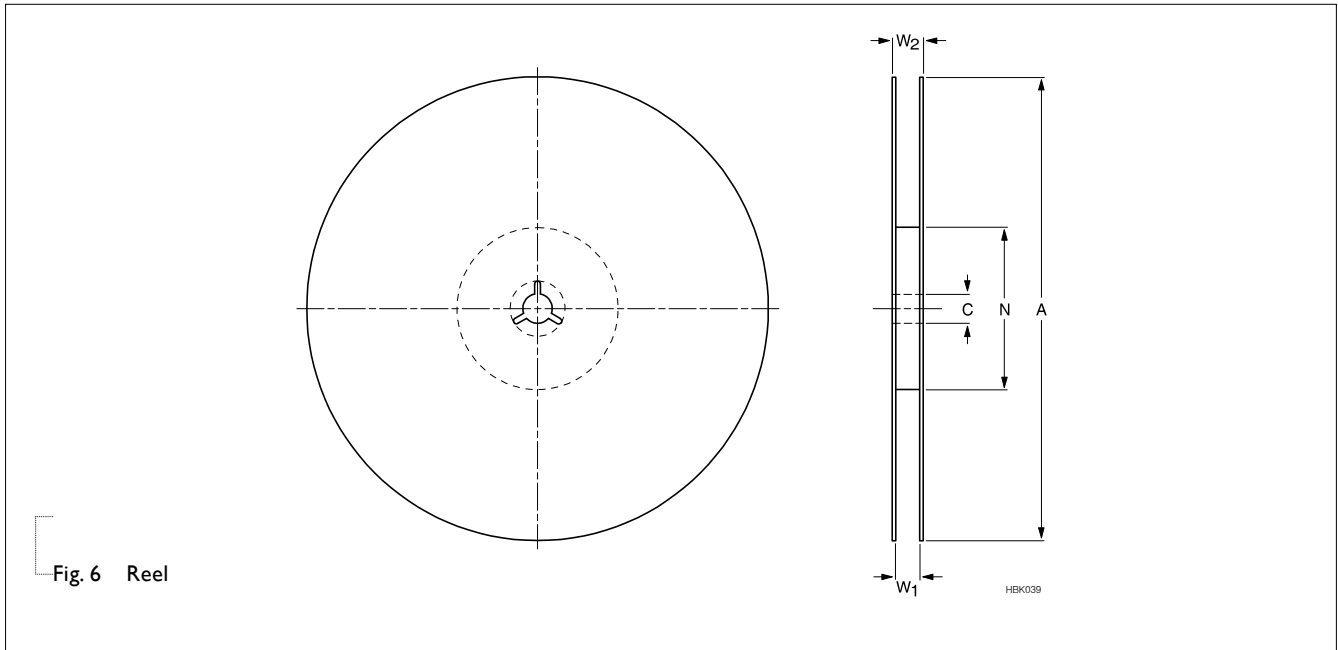
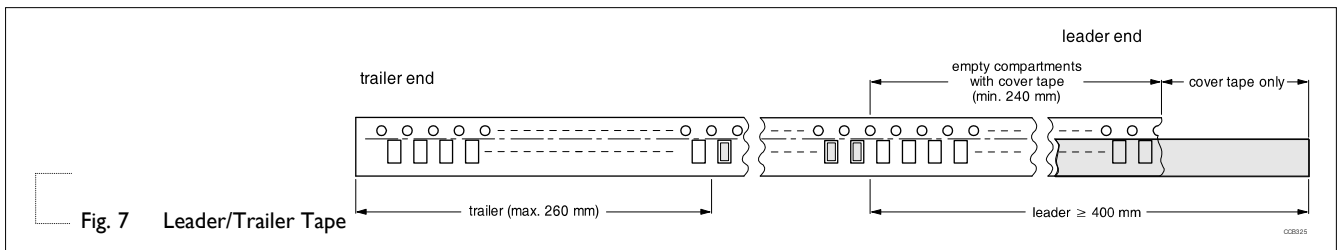

Table 5 Dimensions of reel specification for relevant chip resistors size

SIZE	QUANTITY PER REEL	REEL SIZE	SYMBOL					Unit: mm	
		8 mm TAPE WIDE	A	N	C	D	W ₁	W ₂ MAX.	
PA0201	10,000	7" (Ø 178 mm)	178.0± 1.0	60.0+1/-0	13.5± 0.5	21.0± 0.8	9.0± 0.5	12.0± 0.2	
PA0402	10,000	7" (Ø 178 mm)	178.0± 1.0	60.0+1/-0	13.5± 0.5	21.0± 0.8	9.0± 0.5	12.0± 0.2	
PA0603	5,000	7" (Ø 178 mm)	178.0± 1.0	60.0+1/-0	13.5± 0.5	21.0± 0.8	9.0± 0.5	12.0± 0.2	
PA0805	5,000	7" (Ø 178 mm)	178.0± 1.0	60.0+1/-0	13.5± 0.5	21.0± 0.8	9.0± 0.5	12.0± 0.2	

LEADER/TRAILER TAPE SPECIFICATION



FOOTPRINT AND SOLDERING PROFILES

For recommended soldering profiles, please refer to data sheet “Chip resistors mounting”.

FOOTPRINT

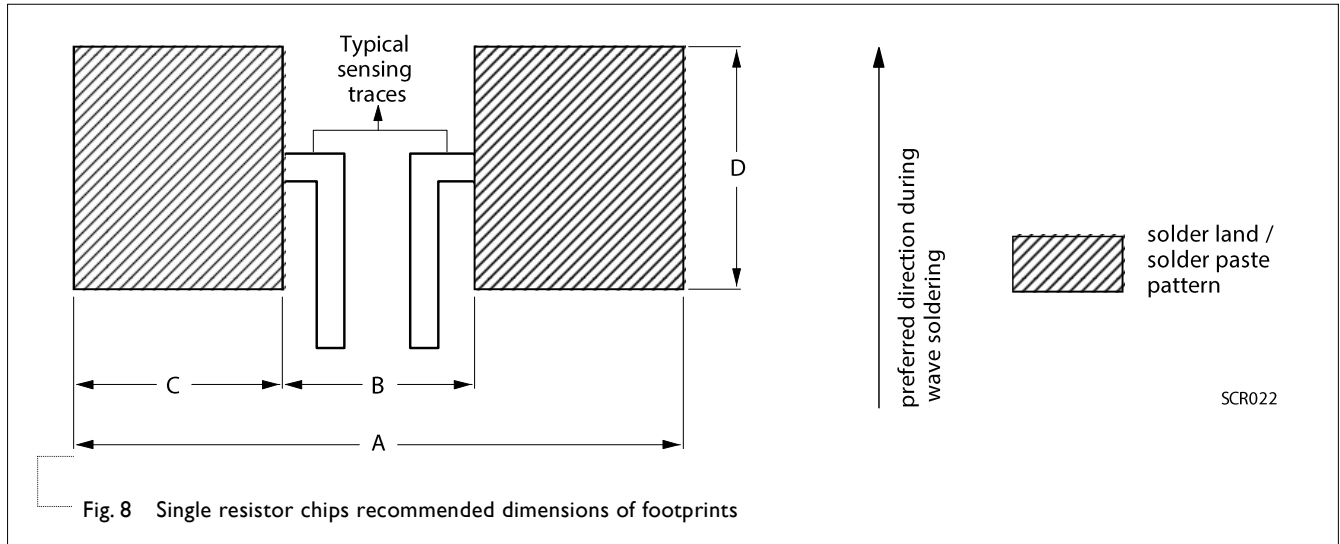

Table 6 Footprint dimensions

Unit: mm

SIZE	A	B	C	D
PA0201	1.0	0.3	0.35	0.4
PA0402	2.0	0.4	0.8	0.6
PA0603	2.2	0.8	0.7	0.9
PA0805	3.4	0.8	1.3	1.3

TESTS AND REQUIREMENTS
Table 7 Test condition, procedure and requirements

TEST	TEST METHOD	PROCEDURE	REQUIREMENT
Life/ Endurance	MIL-STD-202 Method 108	1,000 hours at 70±2°C applied RCWV	0201: < 5mΩ
	IEC 60115-1 4.25.1	1.5 hours on, 0.5 hour off, still air required	0402: < 1mΩ
			< 0.5mΩ
			0603: < 0.2mΩ
0805: < 0.2mΩ			
High Temperature Exposure/ Endurance at upper category temperature	MIL-STD-202 Method 108	1,000 hours, unpowered at	0201: < 5mΩ
	IEC 60115-1 4.25.3	0201/ 0402: 125±5°C	0402: < 1mΩ
			< 0.5mΩ
			0603: < 0.2mΩ
0805: < 0.2mΩ			
Moisture Resistance	MIL-STD-202 Method 106	Each temperature / humidity cycle is defined at 8 hours (Method 106G), 3 cycles / 24 hours for 10d. with 25 °C / 65 °C 95% R.H, without steps 7a & 7b, un-powered Parts mounted on test board, without condensation on parts Measurement at 24±2 hours after test conclusion.	0201: < 5mΩ
			0402: < 1mΩ
			< 0.5mΩ
			0603: < 0.2mΩ
0805: < 0.2mΩ			
No visible damage			
Thermal Shock	MIL-STD-202 Method 107	-55/+125°C Note: Number of cycles required is 300. Parts mounted on test board. Maximum transfer time is 20 seconds. Dwell time is 15 minutes.	0201: < 5mΩ
			0402: < 1mΩ
			< 0.5mΩ
			0603: < 0.2mΩ
0805: < 0.2mΩ			
Short time overload	IEC 60115-1 4.13	5 times rated power for 5 seconds.	0201: < 5mΩ
			0402: < 1mΩ
			< 0.5mΩ
			0603: < 0.2mΩ
0805: < 0.2mΩ			
No visible damage			
Board Flex/ Bending	IEC 60115-1 4.33	Device mounted on PCB test board as described, only 1 board bending required Bending for 0201: 3 mm 0402 and above: 2mm Bending time: 60±1 seconds Ohmic value checked during bending	0201: < 5mΩ
			0402: < 1mΩ
			< 0.5mΩ
			0603: < 0.2mΩ
0805: < 0.2mΩ			

TEST	TEST METHOD	PROCEDURE	REQUIREMENT
Solderability - Wetting	IPC/JEDEC J-STD-002B test B	Electrical Test not required Magnification 50X SMD conditions: 1st step: Method B, aging 4 hours at 155°C dry heat 2nd step: lead free solder bath at 245±3°C Dipping time: 3±0.5 seconds	Well tinned (>95% covered) No visible damage
- Leaching	IPC/JEDEC J-STD-002B test D	Lead free solder, 260°C, 30 seconds immersion time	No visible damage
- Resistance to Soldering Heat	MIL-STD-202 Method 210 IEC 60115-1 4.18	Condition B, no pre-heat of samples Lead free solder, 260±5°C, 10±1 seconds immersion time Procedure 2 for SMD: devices fluxed and cleaned with isopropanol	0201: < 5mΩ 0402: < 1mΩ < 0.5mΩ 0603: < 0.2mΩ 0805: < 0.2mΩ No visible damage

REVISION HISTORY

REVISION	DATE	CHANGE NOTIFICATION	DESCRIPTION
----------	------	---------------------	-------------

Version 0	Oct. 05, 2018	-	- Metal low ohmic jumper - PA series
-----------	---------------	---	--------------------------------------

“Yageo reserves all the rights for revising the content of this datasheet without further notification, as long as the products itself are unchanged. Any product change will be announced by PCN.”

X-ON Electronics

Largest Supplier of Electrical and Electronic Components

Click to view similar products for [Yageo manufacturer](#):

Other Similar products are found below :

[CC1812KKX7RDBB103](#) [PHG1-KIT](#) [PR03/15K](#) [MRS25/470R/1](#) [2238-580-15641](#) [2238-580-15648](#) [2238-580-16618](#) [2238-586-15639](#) [2238-586-15641](#) [2238-586-15646](#) [2238-586-15648](#) [2238-587-15623](#) [2238-861-15108](#) [2238-861-15121](#) [2238-861-15129](#) [2238-861-15689](#) [2238-863-55331](#) [2238-867-15128](#) [2238-867-15181](#) [2238-867-15479](#) [2238-867-15561](#) [2238-867-15621](#) [2322-702-60229](#) [2322-702-60271](#) [2322-702-60683](#) [2322-704-61101](#) [2322-704-61109](#) [2322-704-61209](#) [2322-704-61303](#) [2322-704-61604](#) [2322-704-62202](#) [2322-704-62404](#) [2322-704-62702](#) [2322-704-62942](#) [2322-704-63012](#) [2322-704-64303](#) [2322-704-65492](#) [2322-704-66202](#) [2322-704-66204](#) [2322-704-67501](#) [2322-704-68201](#) [2322-711-41301](#) [2322-711-61109](#) [2322-711-61124](#) [2322-711-61223](#) [2322-711-61229](#) [2322-711-61272](#) [2322-711-61339](#) [2322-711-61681](#) [2322-724-61008](#)