

DATA SHEET

**CURRENT SENSOR - LOW TCR
AUTOMOTIVE GRADE**

PA series

5%, 1%

sizes 2512

RoHS compliant & Halogen free



SCOPE

This specification describes PA series current sensor - low TCR with lead-free terminations made by metal substrate.

APPLICATIONS

- Consumer goods
- Computer
- Telecom / Datacom
- Industrial / Power supply
- Alternative Energy
- Car electronics

FEATURES

- Comply with AEC-Q200 standard
- Halogen-free Epoxy
- RoHS compliant
- Reduce environmentally hazardous wastes
- High component and equipment reliability
- Non-forbidden materials used in products/production
- Low resistances applied to current sensing

ORDERING INFORMATION - GLOBAL PART NUMBER

Global part numbers are identified by the series, size, tolerance, packing type, temperature coefficient, taping reel and resistance value.

GLOBAL PART NUMBER

PA XXXX X X X XX XXXX L
(1) (2) (3) (4) (5) (6) (7)

(1) SIZE

2512

(2) TOLERANCE

F = ±1%
 J = ±5%

(3) PACKAGING TYPE

K = Embossed taping reel

(4) TEMPERATURE COEFFICIENT OF RESISTANCE

F = ±100 ppm/°C
 H = ±275 ppm/°C

(5) TAPING REEL

07 / 7W / 7T = 7 inch dia. Reel and specific rated power
 Detailed power rating are shown in the Table 2.

(6) RESISTANCE VALUE

1 mΩ to 5 mΩ

(7) DEFAULT CODE

Letter L is the system default code for ordering only. (Note)

| Resistance code rule | Example |
|-------------------------|--------------|
| 0RXXXX (0.1 to 5 mΩ) | 0R001 = 1 mΩ |

ORDERING EXAMPLE

The ordering code of a PA2512 1W chip resistor, TC100, value 0.003Ω with ±1% tolerance, supplied in 7-inch tape reel is: PA2512FKF070R003L

NOTE

1. All our RChip products are RoHS compliant. "LFP" of the internal 2D reel label mentions "Lead-Free Process"

MARKING

PA2512

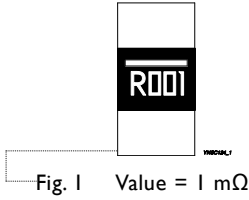

4 digits
The “R” is used as a decimal point; the other 3 digits are significant
PA2512: 1mΩ to 4 mΩ

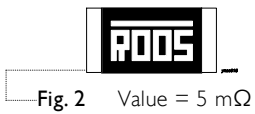

4 digits
The “R” is used as a decimal point; the other 3 digits are significant
PA2512: 5 mΩ

CONSTRUCTION

The resistors are constructed using outstanding TCR level material, which makes Yageo PA resistors excellent for current sensing application in battery charger circuit & DC-DC converter.

The composition of the resistive material is adjusted to give the approximate required resistance and is covered with a protective coating. Marking is printed on the top side of the resistor.

Finally, the three external terminations (Cu / Ni / matte Tin) are added, as shown in Fig. 4.

Outlines

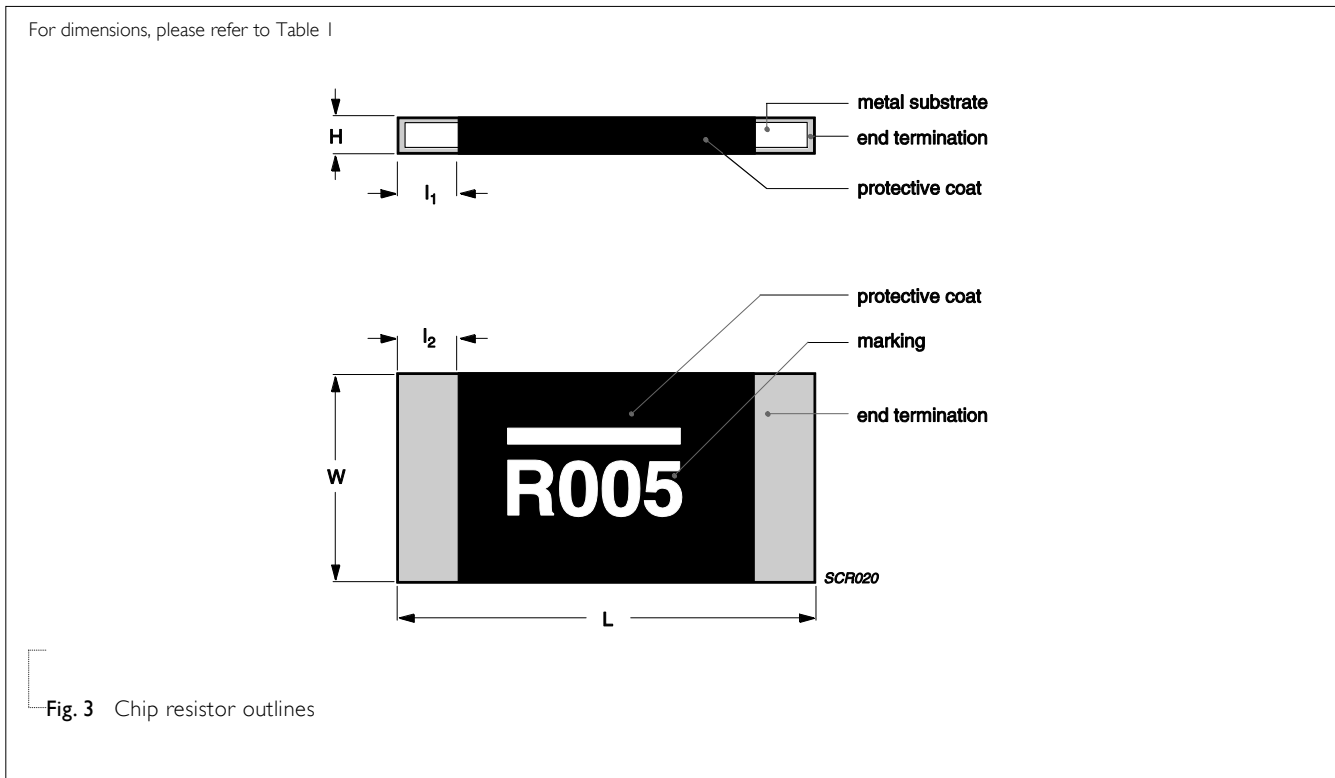

DIMENSION

Table 1 For outlines, please refer to Fig. 4

| TYPE | RESISTANCE RANGE | POWER RATING | L (mm) | W (mm) | H (mm) | l ₁ (mm) | l ₂ (mm) |
|--------|---|--------------|-----------------|-----------------|-----------------|---------------------|---------------------|
| PA2512 | $1\text{m}\Omega \leq R \leq 4\text{m}\Omega$ | 1W | 6.35 ± 0.25 | 3.18 ± 0.25 | 0.63 ± 0.25 | 2.21 ± 0.25 | 2.21 ± 0.25 |
| | $5\text{m}\Omega$ | 2W 3W | 6.35 ± 0.25 | 3.18 ± 0.25 | 0.63 ± 0.25 | 1.19 ± 0.25 | 1.19 ± 0.25 |

Note:

1. For relevant physical dimensions, please refer to construction outlines.
2. Please contact with sales offices, distributors and representatives in your region before ordering.

ELECTRICAL CHARACTERISTICS

Table 2

| SERIES | SIZE | POWER RATING | | | | TOLERANCE | RESISTANCE RANGE | TEMPERATURE COEFFICIENT OF RESISTANCE | |
|--------|------|--------------|----|----|-----|------------|------------------|---------------------------------------|-------------|
| | | 07 | 7W | 7T | 47 | | | 1mΩ | ±275 ppm/°C |
| PA | 2512 | 1W | 2W | 3W | --- | ±1% ±5% | 1 mΩ ≤ R ≤ 5 mΩ | 2mΩ < R ≤ 5mΩ | ±100 ppm/°C |

Note: Please contact with sales offices, distributors and representatives in your region before ordering.

FUNCTIONAL DESCRIPTION

OPERATING TEMPERATURE RANGE

PA2512 Range: -55°C to +170°C

POWER RATING

Standard rated power at 70°C:

For detail power value, please refer to Table 2.

RATED VOLTAGE

The DC or AC (rms) continuous working voltage corresponding to the rated power is determined by the following formula:

$$V = \sqrt{P \times R}$$

Where

V = Continuous rated DC or AC (rms) working voltage (V)

P = Rated power (W)

R = Resistance value (Ω)

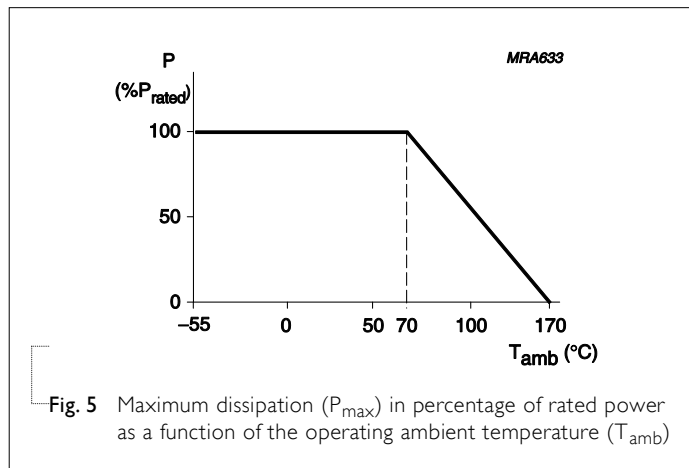

Fig. 5 Maximum dissipation (P_{max}) in percentage of rated power as a function of the operating ambient temperature (T_{amb})

PACKING STYLE AND PACKAGING QUANTITY

Table 3 Packing style and packaging quantity

| PACKING STYLE | REEL DIMENSION | PA2512 |
|--------------------------|----------------|--------|
| Embossed taping reel (K) | 7" (178 mm) | 4,000 |

EMBOSSED TAPE

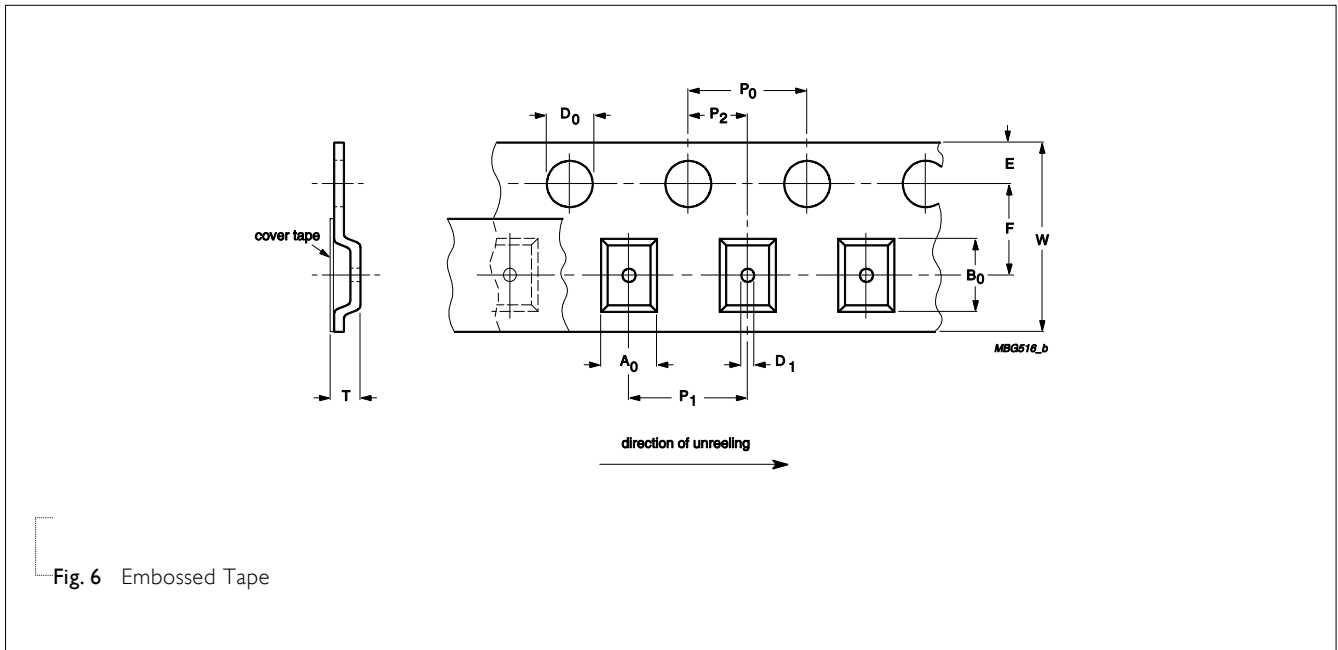

Fig. 6 Embossed Tape

Table 4 Dimensions of embossed tape for relevant chip resistors size

| SIZE | SYMBOL | | | | | | | | | | Unit: mm |
|--------|----------------|----------------|------------|-----------|-----------|----------------|----------------|----------------|-----------------|-----------------|-----------|
| | A ₀ | B ₀ | W | E | F | P ₀ | P ₁ | P ₂ | ØD ₀ | ØD ₁ | T |
| PA2512 | 3.40±0.15 | 6.70±0.15 | 12.00±0.30 | 1.75±0.10 | 5.50±0.10 | 4.00±0.10 | 4.00±0.10 | 2.00±0.10 | 1.55±0.05 | 1.50±0.10 | 0.80±0.15 |

REEL SPECIFICATION

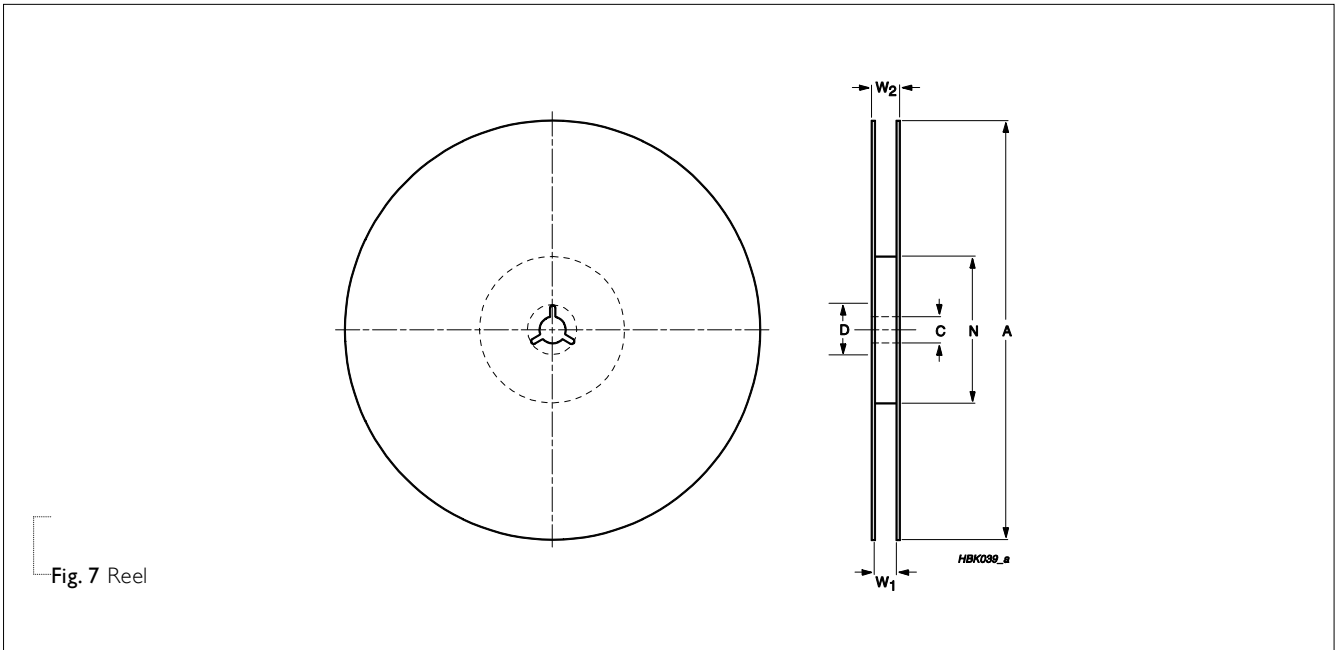
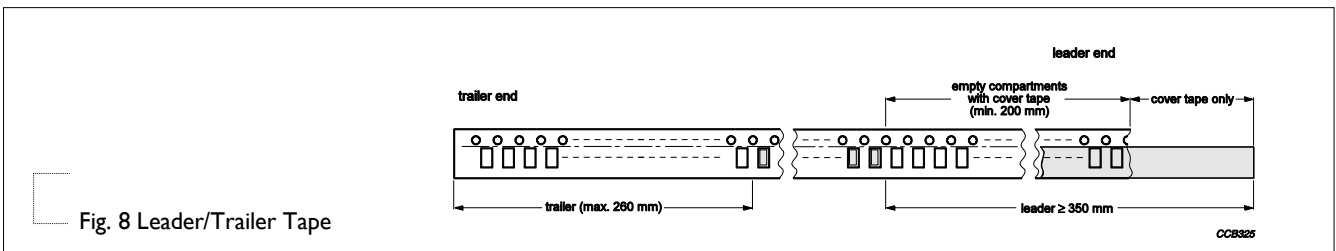

Table 5 Dimensions of reel specification for relevant chip resistors size

| SIZE | QUANTITY PER REEL | REEL SIZE | | SYMBOL | | | | Unit: mm | |
|--------|-------------------|----------------|-----------------|-----------|-----------|-----------|----------|----------------|---------------------|
| | | 8 mm TAPE WIDE | 12 mm TAPE WIDE | A | N | C | D | W ₁ | W ₂ MAX. |
| PA2512 | 4000 | -- | 7" (Ø178 mm) | 178.0±1.0 | 60.0+1/-0 | 13.50±0.5 | 21.0±0.8 | 13.6±0.5 | 16.5±0.5 |

LEADER/TRAILER TAPE SPECIFICATION



FOOTPRINT AND SOLDERING PROFILES

For recommended soldering profiles, please refer to data sheet “Chip resistors mounting”.

FOOTPRINT

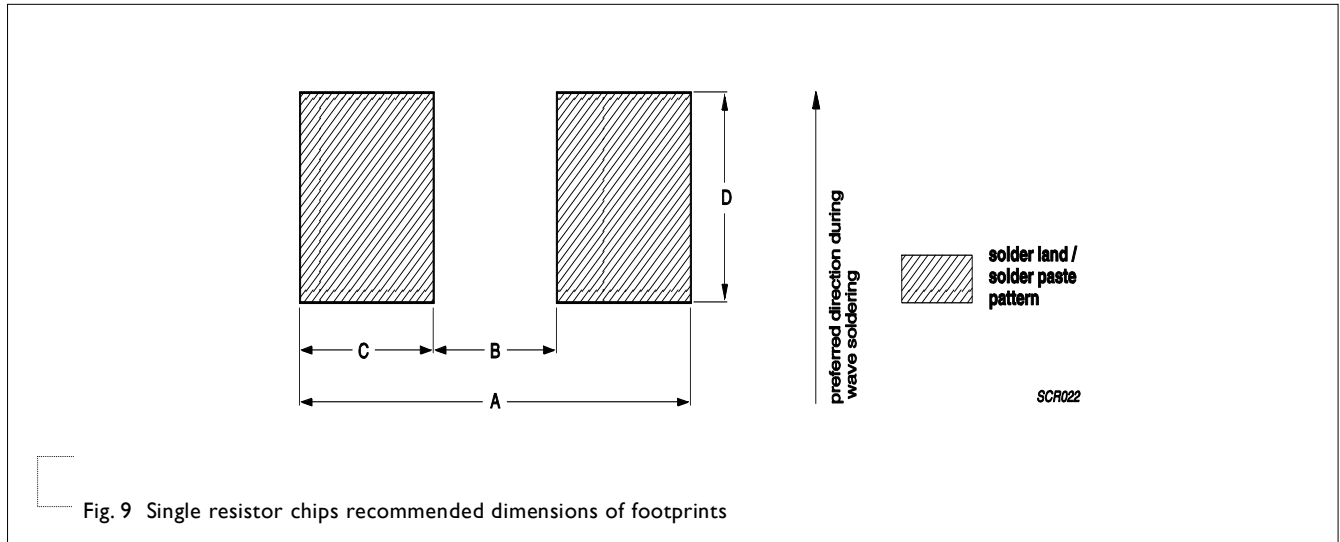

Table 6 Footprint dimensions

| SIZE | RESISTANCE RANGE | POWER RATING | Unit: mm | | | |
|--------|---|--------------|----------|------|------|------|
| | | | A | B | C | D |
| PA2512 | $1\text{m}\Omega \leq R \leq 4\text{m}\Omega$ | 1W, 2W, 3W | 7.37 | 1.27 | 3.05 | 3.68 |
| | 5mΩ | | 7.40 | 3.18 | 2.11 | 3.68 |

TESTS AND REQUIREMENTS

Table 8 Test condition, procedure and requirements

| TEST | TEST METHOD | PROCEDURE | REQUIREMENT |
|---|--|---|--|
| Short time overload | IEC60115-1 4.13 | 5 times of rated power for 5 seconds at room temperature | $\pm(0.5\%+0.0005\Omega)$ No visible damage |
| High Temperature Exposure/ Endurance at Upper Category Temperature | MIL-STD-202G-Method 108A | 1,000 hours at maximum operating temperature depending on specification, unpowered No direct impingement of forced air to the parts Tolerances: $170\pm 3^{\circ}\text{C}$ | $\pm(1.0\%+0.0005\Omega)$ |
| Temperature Cycling | JESD22-A104C | 1,000 cycles, $-55/+125^{\circ}\text{C}$ for 1 cycle per hour | $\pm(0.5\%+0.0005\Omega)$ |
| Moisture Resistance | MIL-STD-202G-Method 106F | Each temperature / humidity cycle is defined at 8 hours (method 106F), 3 cycles / 24 hours for 10d with 25°C / 65°C 95% R.H, without steps 7a & 7b, unpowered | $\pm(0.5\%+0.0005\Omega)$ |
| Biased Humidity | MIL-STD-202 Method 103 | 1,000 hours; 85°C / 85% RH 10% of operating power | $\pm(0.5\%+0.0005\Omega)$ |
| Operational Life/ Endurance | MIL-STD-202G-Method 108A IEC 60115-1 4.25.1 | 1,000 hours at $125\pm 3^{\circ}\text{C}$, de-rated voltage applied for 1.5 hours on, 0.5 hour off, still-air required | $\pm(1.0\%+0.0005\Omega)$ |
| | | 1,000 hours at $70\pm 2^{\circ}\text{C}$ applied RCWV 1.5 hours on, 0.5 hour off, still air required | $\pm(1.0\%+0.0005\Omega)$ |
| Resistance to Solvents | MIL-STD-202 Method 215 | Immerse in isopropyl alcohol for 5 min with ultrasonic at room temperature | $\pm(1.0\%+0.0005\Omega)$ |
| Mechanical Shock | MIL-STD-202 Method 213 | Three shocks in each direction shall be applied along the three mutually perpendicular axes of the test specimen. Peak value: 1,500 g's Duration: 0.5 ms Velocity change: 15.4 ft/s Waveform: Half sine | $\pm(0.5\%+0.0005\Omega)$ |
| Vibration | MIL-STD-202 Method 204 | 5 g's for 20 min., 12 cycles each of 3 orientations Test from 10-2000 Hz. | $\pm(0.5\%+0.0005\Omega)$ |
| Resistance to Soldering Heat | MIL-STD-202G-method 210F | Condition B, no pre-heat of samples Leadfree solder, 260°C , 10 seconds immersion time Procedure 2 for SMD: devices fluxed and cleaned with isopropanol | $\pm(0.5\%+0.0005\Omega)$ No visible damage |
| Thermal Shock | MIL-STD-202 Method 107 | $-55/+150^{\circ}\text{C}$, Number of cycles is 300. Maximum transfer time is 20 seconds. Dwell time is 15 minutes. Air -Air | $\pm(0.5\%+0.0005\Omega)$ No visible damage |

| TEST | TEST METHOD | PROCEDURE | REQUIREMENT |
|--|-----------------------|--|---|
| Electrostatic Discharge | AEC-Q200-002 | Human Body Model, 1 pos + 1 neg. Discharges 2512=2KV | $\pm(1.0\%+0.0005\Omega)$ No visible damage |
| Solderability - Wetting | J-STD-002 | (a) Method B, aging 4 hours at 155°C dry heat, dipping at 235±3°C for 5±0.5 seconds. (b) Method B, steam aging 8 hours, dipping at 215±3°C for 5±0.5 seconds. (c) Method D, steam aging 8 hours, dipping at 260±3 °C for 7±0.5 seconds. | Well tinned (>95% covered) No visible damage |
| Flammability | UL94 | Try to inflame a specimen by a needle flame | No ignition of specimen; V-0 |
| Board Flex / Bending | AEC-Q200-005 | Chips mounted on a 90mm glass epoxy resin PCB (FR4), Bending for 2512=2 mm Holding time: Min.60 seconds | $\pm(1.0\%+0.0005\Omega)$ |
| Terminal Strength (SMD) | AEC-Q200-006 | Applied a 17.7N (1.8Kg) for 60±1 seconds. | $\pm(1.0\%+0.0005\Omega)$ No visible damage |
| Flame Retardance | AEC-Q200-001 | Apply voltage from 9V to 32V to increase the surface temp to 350°C | No flame, no explosion |
| Temperature Coefficient of Resistance (T.C.R.) | IEC 60115-1 4.8 | At +25/-55°C and +25/+125°C Formula: $T.C.R = \frac{R_2 - R_1}{R1(t_2 - t_1)} \times 10^6(\text{ppm}/^\circ\text{C})$ Where t1=+25°C or specified room temperature t2=-55°C or +125°C test temperature R1=resistance at reference temperature in ohms R2=resistance at test temperature in ohms | Refer to table 2 |
| Flower-of-Sulfur (FOS) | Modified ASTM B809-95 | Sulfur 105°C, 750 hours, unpowered. | $\pm(1.0\%+0.0005\Omega)$ |

REVISION HISTORY

| REVISION | DATE | CHANGE NOTIFICATION | DESCRIPTION |
|-----------|---------------|---------------------|---|
| Version 0 | Aug. 22, 2014 | - | - New datasheet for automotive grade current sensor -PA series. |

“Yageo reserves all the rights for revising the content of this datasheet without further notification, as long as the products itself are unchanged. Any product change will be announced by PCN.”

X-ON Electronics

Largest Supplier of Electrical and Electronic Components

Click to view similar products for [Current Sense Resistors - SMD category](#):

Click to view products by [Yageo manufacturer](#):

Other Similar products are found below :

[5112](#) [65709-330JE](#) [PF2512FKF7W0R007L](#) [PR2512FKF7W0R003L](#) [PR2512FKF7W0R005L](#) [RCWL0603R500JNEA](#) [ERJ-3BQF1R1V](#) [ERJ-L14UJ42MU](#) [2-2176088-5](#) [PF2512FKF7W0R006L](#) [PF2512FKF7W0R033L](#) [2-2176089-4](#) [CD2015FC-0.10-1%](#) [PR2512FKF7W0R004L](#) [CGSSL1R01J](#) [CGSSL1R047J](#) [RC1005F124CS](#) [RCWE2512R110FKEA](#) [RCWL0805R330JNEA](#) [RL73H3AR47FTE](#) [RL73K3AR56JTDF](#) [RL7520WT-R001-F](#) [RL7520WT-R009-G](#) [RL7520WT-R020-F](#) [RLP73N1ER43JTD](#) [TL3AR01FTDG](#) [TLR3A20DR0005FTDG](#) [LRC-LR2512LF-01-R820J](#) [ERJ-3BQF4R3V](#) [ERJ-L14UF68MU](#) [TLR3A20DR001FTDG](#) [TLR3A30ER0005FTDG](#) [WR06X104JGLJ](#) [RLP73K1ER82JTD](#) [TL2BR01F](#) [TLR3A20DR01FTDG](#) [WSR3R0600FEA32](#) [ERJ-14BQF1R6U](#) [ERJ-14BQJR30U](#) [SP1220RJT](#) [SP1R12J](#) [ERJ-14BQF6R2U](#) [RL7520WT-R039-G](#) [PF1206FRF7W0R02L](#) [RL7520WT-R002-F](#) [RL7520WT-R047-F](#) [RLP73N2BR068FTDF](#) [RL7520WT-R005-F](#) [RCWE2512R220FKEA](#) [RCWE120625L0FMEA](#)