

DATA SHEET

CURRENT SENSOR - LOW TCR

AUTOMOTIVE GRADE

PE_L series

5%, 1%, 0.5%, 0.1%

sizes

0100/ 0201/ 0402/ 0603/ 0805/ 1206/ 2010/ 2512/ 2817/ 4527

RoHS compliant & Halogen free



SCOPE

This specification describes PE series current sensor - low TCR with lead-free terminations made by metal film with ceramic substrate.

APPLICATIONS

- Consumer goods
- Computer
- Telecom / Datacom
- Industrial / Power supply
- Automotive
- Alternative Energy

FEATURES

- AEC-Q200 qualified
- Halogen-free Epoxy
- RoHS compliant
- Reduce environmentally hazardous wastes
- High component and equipment reliability
- None forbidden-materials used in products/production
- Low resistances applied to current sensing

ORDERING INFORMATION - GLOBAL PART NUMBER

Global part numbers are identified by the series, size, tolerance, packing type, temperature coefficient, taping reel and resistance value.

GLOBAL PART NUMBER

PE XXXX X X X XX XXXX L
 (1) (2) (3) (4) (5) (6) (7)

(1) SIZE

0100/ 0201/ 0402/ 0603/ 0805/ 1206/ 2010/ 2512/ 2817/ 4527

(2) TOLERANCE

- B = ±0.1%
- D = ±0.5%
- F = ±1%
- J = ±5%

(3) PACKAGING TYPE

- R = Paper/ PE taping reel
- K = Embossed taping reel

(4) TEMPERATURE COEFFICIENT OF RESISTANCE

- E = ±50 ppm/°C
- M = ±75 ppm/°C
- F = ±100 ppm/°C
- G = ±200ppm/C
- I = ±300ppm/°C
- J = ±350 ppm/°C

(5) TAPING REEL

07 / 7W / 7T / 47 / 57= 7 inch dia. Reel and specific rated power.
 Detailed power rating are shown in the Table 2.

(6) RESISTANCE VALUE

5 mΩ to 1Ω
 There are 3~5 digits indicated the resistance value. Letter R is decimal point.
 Detailed coding rules of resistance are shown in the table of "Resistance rule of global part number".

(7) DEFAULT CODE

Letter L is the system default code for ordering only. (Note)

Resistance code rule	Example
0RXXX	0R001 = 1 mΩ
(1 to 9)10 mΩ	0R1 = 100 mΩ
	0R91 = 910 mΩ

ORDERING EXAMPLE

The ordering code of a PE2512 1W chip resistor, value 0.1 Ω with ±1% tolerance, supplied in 7-inch tape reel is: PE2512FKM070R1L

NOTE

1. All our RSMD products are RoHS compliant. "LFP" of the internal 2D reel label mentions "Lead-Free Process"

MARKING

PE0100

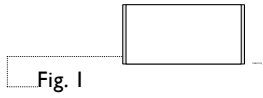

No marking

PE0201 / PE0402



No marking

PE0603

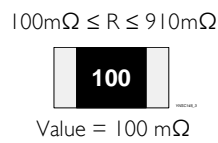
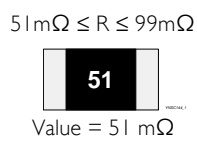
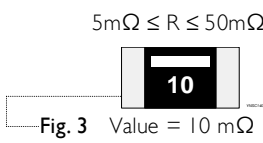

2 digits
resistance range: 5mΩ ≤ R ≤ 99mΩ

3 digits
resistance range: 100mΩ ≤ R ≤ 910mΩ

PE0805

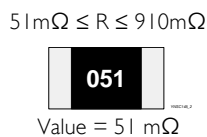
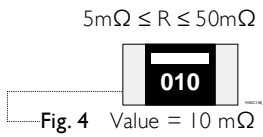

3 digits

PE1206

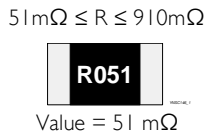
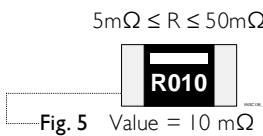

4 digits

The “R” is used as a decimal point; the other 3 digits are significant.

PE2010 / PE2512 (1W&2W)

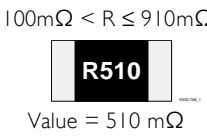
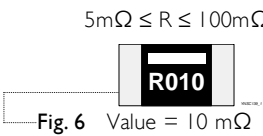

4 digits

The “R” is used as a decimal point; the other 3 digits are significant.

PE2512 (3W&5W) / PE2817

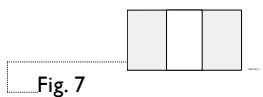

No marking

PE4527

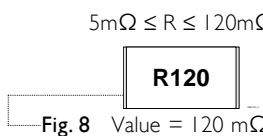

4 digits

The “R” is used as a decimal point; the other 3 digits are significant.

Outlines

For dimensions, please refer to Table I

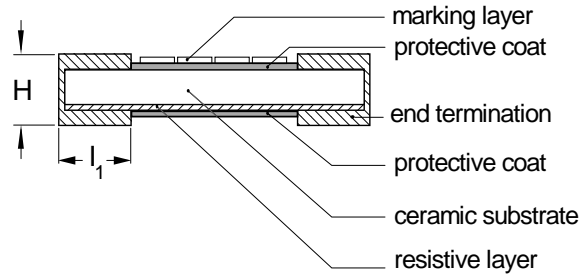
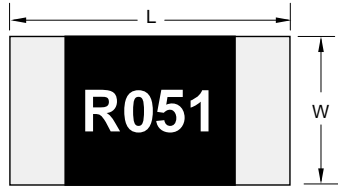

YNSC143_1

Fig. 9 Chip resistor outlines for PE0100~PE4527

For dimensions, please refer to Table I

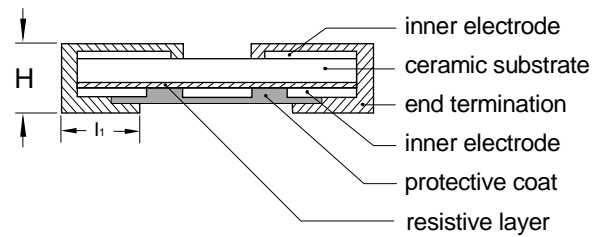
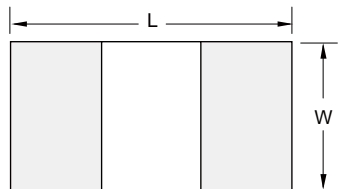

YNSC143_2

Fig. 10 Chip resistor outlines for PE2512 (3W&5W) / PE2817

DIMENSION

Table 1 For outlines, please refer to Fig. 9 & Fig. 10

TYPE	RESISTANCE RANGE	L (mm)	W (mm)	H (mm)	l ₁ (mm)
PE0100	100 mΩ ≤ R ≤ 1 Ω	0.40±0.03	0.20±0.03	0.14±0.03	0.10±0.03
PE0201	50 mΩ ≤ R ≤ 910 mΩ	0.60±0.03	0.31±0.04	0.27±0.04	0.14±0.06
PE0402	10 mΩ ≤ R ≤ 910 mΩ	1.00+0.10/-0.15	0.50+0.10/-0.15	0.35±0.15	0.25±0.10
PE0603	5 mΩ ≤ R ≤ 50 mΩ	1.60±0.20	0.76±0.25	0.35±0.25	0.38±0.25
	51 mΩ ≤ R ≤ 910 mΩ	1.52±0.25	0.76±0.25	0.45±0.10	0.38±0.25
PE0805	5 mΩ ≤ R ≤ 6 mΩ	2.03±0.25	1.27±0.25	0.35±0.25	0.73±0.25
	7 mΩ ≤ R ≤ 50 mΩ	2.03±0.25	1.27±0.25	0.35±0.25	0.38±0.25
	51 mΩ ≤ R ≤ 910 mΩ	2.03±0.25	1.27±0.25	0.55±0.10	0.35±0.20
PE1206	5 mΩ	3.20±0.25	1.60±0.25	0.64±0.25	0.64±0.25
	6 mΩ ≤ R ≤ 910 mΩ	3.20±0.25	1.60±0.25	0.64±0.25	0.51±0.25
PE2010	5 mΩ ≤ R ≤ 6 mΩ	5.08±0.25	2.54±0.25	0.64±0.25	1.47±0.25
	7 mΩ ≤ R ≤ 910 mΩ	5.08±0.25	2.54±0.25	0.64±0.25	0.51±0.25
PE2512 1W&2W	6 mΩ ≤ R ≤ 910 mΩ	6.35±0.25	3.18±0.25	0.64±0.25	0.76±0.25
PE2512 3W&5W	20 mΩ ≤ R ≤ 910 mΩ	6.35±0.25	3.15±0.25	0.64±0.25	0.90±0.25
PE2817	20 mΩ ≤ R ≤ 910 mΩ	7.10±0.25	4.20±0.25	0.64±0.25	1.00±0.25
PE4527	5 mΩ	11.75±0.45	7.20±0.45	0.65±0.20	3.00±0.45
	6 mΩ ≤ R ≤ 120 mΩ	11.75±0.45	7.20±0.45	0.65±0.20	2.70±0.45

Note:

1. For relevant physical dimensions, please refer to construction outlines.
2. Please contact with sales offices, distributors and representatives in your region before ordering.

ELECTRICAL CHARACTERISTICS

Table 2

SERIES	SIZE	POWER RATING @ 70°C (1)					TOLERANCE	RESISTANCE RANGE	TEMPERATURE COEFFICIENT OF RESISTANCE
		07	7W	7T	47	57			
PE	0100	1/32W	1/16W	---	---	---	±1%, ±5%	100 mΩ ≤ R ≤ 299 mΩ 300 mΩ ≤ R ≤ 1Ω	±300 ppm/°C ±200 ppm/°C
	0201	1/20W	1/10W	---	---	---		50 mΩ ≤ R ≤ 70 mΩ 70 mΩ < R ≤ 910 mΩ	±350 ppm/°C ±100 ppm/°C
	0402	1/16W	1/8W	1/6W	1/4W	---		10 mΩ ≤ R ≤ 910 mΩ	±100 ppm/°C
	0603	1/10W	1/5W	1/3W	2/5W	1/2W	±0.1% (only for 0805, >50 mΩ)	5 mΩ ≤ R ≤ 910 mΩ	±75 ppm/°C, ±100 ppm/°C
	0805	1/8W	1/4W	1/3W	1/2W	---	±0.5% (≥10 mΩ)	5 mΩ ≤ R ≤ 19 mΩ	±75 ppm/°C, ±100 ppm/°C
	1206	1/4W	1/2W	---	1W	---	±1% ±5%	20 mΩ ≤ R ≤ 910 mΩ	±50 ppm/°C, ±75 ppm/°C, ±100 ppm/°C
	2010	1/2W	1W	---	---	---		5 mΩ ≤ R ≤ 910 mΩ	±50 ppm/°C, ±75 ppm/°C, ±100 ppm/°C
	2512	1W	2W	---	---	---		6 mΩ ≤ R ≤ 910 mΩ	±50 ppm/°C, ±75 ppm/°C, ±100 ppm/°C
		---	---	3W	---	5W		20 mΩ ≤ R ≤ 910 mΩ	±100 ppm/°C
	2817	7W	---	---	---	---	±0.5%	20 mΩ ≤ R ≤ 910 mΩ	±100 ppm/°C
	4527	2W	3W	---	---	---	±1%, ±5%	5 mΩ ≤ R ≤ 120 mΩ	±75 ppm/°C, ±100 ppm/°C

Note: 1. Global part number (code 10 - 11)

2. Please contact with sales offices, distributors and representatives in your region before ordering.

FUNCTIONAL DESCRIPTION

OPERATING TEMPERATURE RANGE

PE0100 to PE0402 Range: -55°C to +125°C (Fig.11)

PE0603 to PE4527 Range: -55°C to +170°C (Fig.12)

RATED VOLTAGE

The DC or AC (rms) continuous working voltage corresponding to the rated power is determined by the following formula:

$$V = \sqrt{P \times R}$$

Where

V = Continuous rated DC or AC (rms) working voltage (V)

P = Rated power (W)

R = Resistance value (Ω)

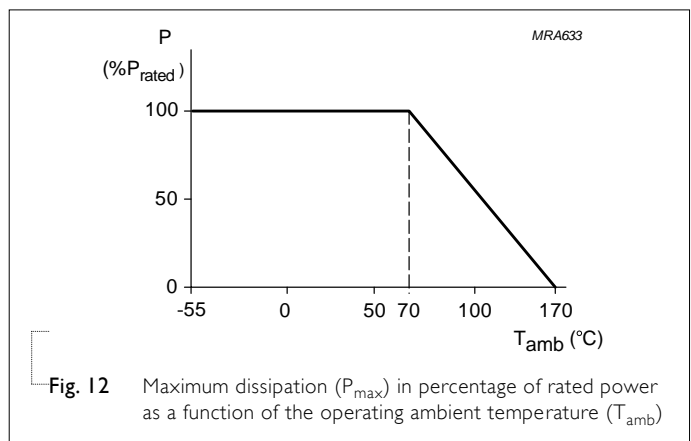
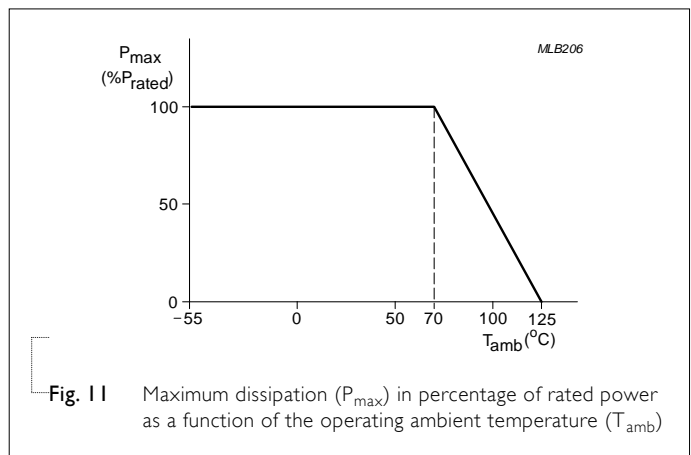

PULSE LOAD BEHAVIOR

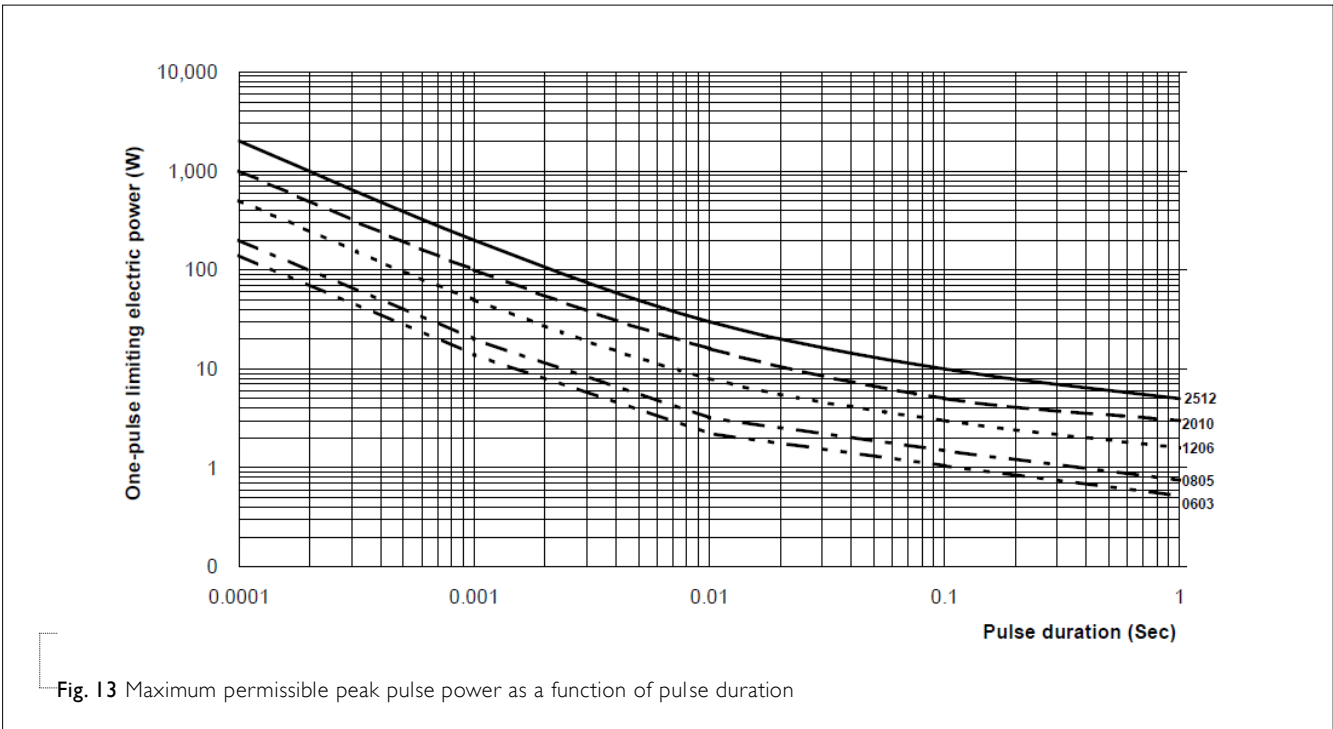

Fig. 13 Maximum permissible peak pulse power as a function of pulse duration

Note: The curve of 2512 above is for 1W&2W

PACKING STYLE AND PACKAGING QUANTITY

Table 3 Packing style and packaging quantity

PACKING STYLE	REEL DIMENSION	PRODUCT SIZE / QUANTITY									
		0100	0201	0402	0603	0805	1206	2010	2512	2817	4527
Paper/PE taping reel (R)	7" (178 mm)	20,000	10,000	10,000	5,000	5,000	4,000	---	---	---	---
Embossed taping reel (K)	7" (178 mm)	---	---	---	---	---	---	4,000	4,000	4,000	1,000

PAPER/PE TAPE

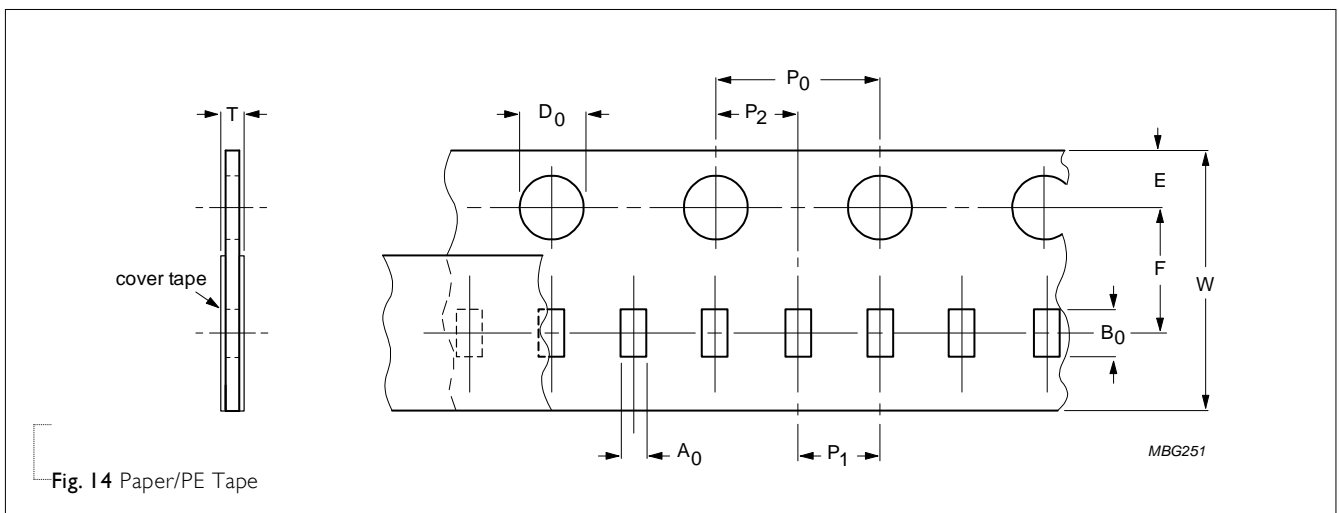

Fig. 14 Paper/PE Tape

Table 4 Dimensions of Paper/PE tape for relevant chip resistors size

SIZE	SYMBOL										Unit: mm
	A ₀	B ₀	W	E	F	P ₀	P ₁	P ₂	ØD ₀	T	
PE0100	0.24±0.03	0.45±0.03	8.00±0.20	1.75±0.10	3.50±0.05	4.00±0.05	2.00±0.10	2.00±0.05	1.50±0.10	0.31±0.10	
PE0201	0.41±0.10	0.70±0.10	8.00±0.30	1.75±0.10	3.50±0.10	4.00±0.10	2.00±0.05	2.00±0.05	1.50±0.10	0.40±0.10	
PE0402	0.65±0.10	1.15±0.10	8.00±0.30	1.75±0.10	3.50±0.10	4.00±0.10	2.00±0.05	2.00±0.05	1.50±0.10	0.53±0.10	
PE0603	1.20±0.15	1.90±0.15	8.00±0.30	1.75±0.10	3.50±0.10	4.00±0.10	4.00±0.10	2.00±0.10	1.50±0.10	0.55±0.15	
PE0805	1.60±0.15	2.30±0.15	8.00±0.30	1.75±0.10	3.50±0.10	4.00±0.10	4.00±0.10	2.00±0.10	1.50±0.10	0.85±0.15	
PE1206	1.90±0.10	3.50±0.10	8.00±0.30	1.75±0.10	3.50±0.10	4.00±0.10	4.00±0.10	2.00±0.10	1.50±0.10	0.85±0.15	

EMBOSED TAPE

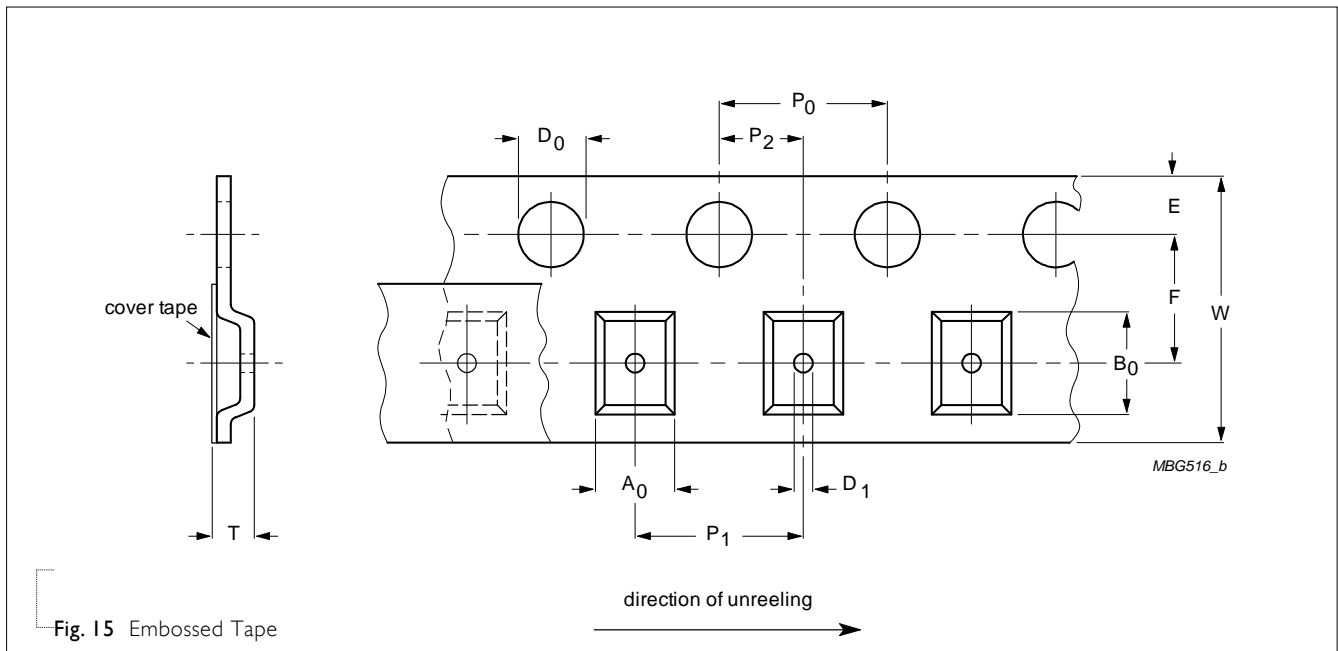

Fig. 15 Embossed Tape

Table 5 Dimensions of embossed tape for relevant chip resistors size

SIZE	SYMBOL										Unit: mm
	A ₀	B ₀	W	E	F	P ₀	P ₁	P ₂	ØD ₀	ØD ₁	
PE2010	3.00±0.15	5.60±0.15	12.10±0.30	1.75±0.10	5.50±0.10	4.00±0.10	4.00±0.10	2.00±0.10	1.50±0.10	1.50±0.10	0.80±0.15
PE2512	3.40±0.15	6.70±0.15	12.10±0.30	1.75±0.10	5.50±0.10	4.00±0.10	4.00±0.10	2.00±0.10	1.50±0.10	1.50±0.10	0.80±0.15
PE2817	4.50±0.20	7.40±0.20	12.00±0.20	1.75±0.10	5.50±0.05	4.00±0.10	4.00±0.10	2.00±0.05	1.50±0.10	1.50±0.10	0.80±0.15
PE4527	7.50±0.15	12.0±0.15	24.00±0.30	1.75±0.10	11.50±0.10	4.00±0.10	8.00±0.10	2.00±0.10	1.50±0.10	1.50±0.10	0.90±0.15

REEL SPECIFICATION

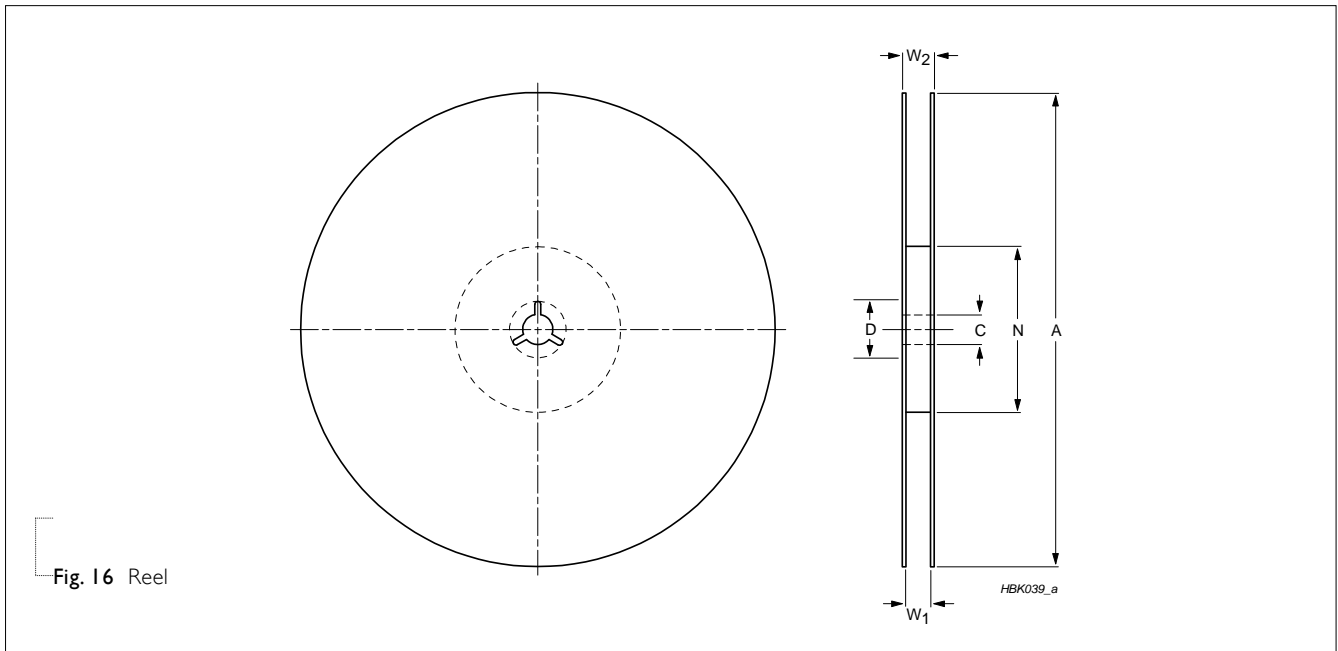

Fig. 16 Reel

Table 6 Dimensions of reel specification for relevant chip resistors size

SIZE	QUANTITY PER REEL	REEL SIZE			SYMBOL						Unit: mm
		8 mm TAPE WIDE	12 mm TAPE WIDE	24 mm TAPE WIDE	A	N	C	D	W ₁	W ₂ MAX.	
PE0100	20,000	7" (Ø178 mm)	---	---	180.0+0/-3	60.0+1/-0	13.0±0.2	21.0±0.8	9.0±0.30	12.4	
PE0201	10,000	7" (Ø178 mm)	---	---	180.0+0/-3	60.0+1/-0	13.0±0.2	21.0±0.8	9.0±0.30	12.4	
PE0402	10,000	7" (Ø178 mm)	---	---	180.0+0/-3	60.0+1/-0	13.0±0.2	21.0±0.8	9.0±0.30	12.4	
PE0603	5,000	7" (Ø178 mm)	--	--	180.0+0/-3	60.0+1/-0	13.0±0.2	21.0±0.8	8.4 +1/-0	12.4	
PE0805	5,000	7" (Ø178 mm)	--	--	180.0+0/-3	60.0+1/-0	13.0±0.2	21.0±0.8	8.4 +1/-0	12.4	
PE1206	4,000	7" (Ø178 mm)	--	--	180.0+0/-3	60.0+1/-0	13.0±0.2	21.0±0.8	8.4 +1/-0	12.4	
PE2010	4,000	-- 7" (Ø178 mm)	--	--	180.0+0/-3	60.0+1/-0	13.0±0.2	21.0±0.8	12.3 +1/-0	18.4	
PE2512	4,000	-- 7" (Ø178 mm)	--	--	180.0+0/-3	60.0+1/-0	13.0±0.2	21.0±0.8	12.3 +1/-0	18.4	
PE2817	4,000	-- 7" (Ø178 mm)	--	--	180.0+0/-3	60.0+1/-0	13.0±0.2	21.0±0.8	12.3 +1/-0	18.4	
PE4527	1,000	--	--	7" (Ø178 mm)	178.0±1.0	60.0±1.0	13.5±0.5	17.7.±0.5	24.0±1.0	26.5	

LEADER/TRAILER TAPE SPECIFICATION

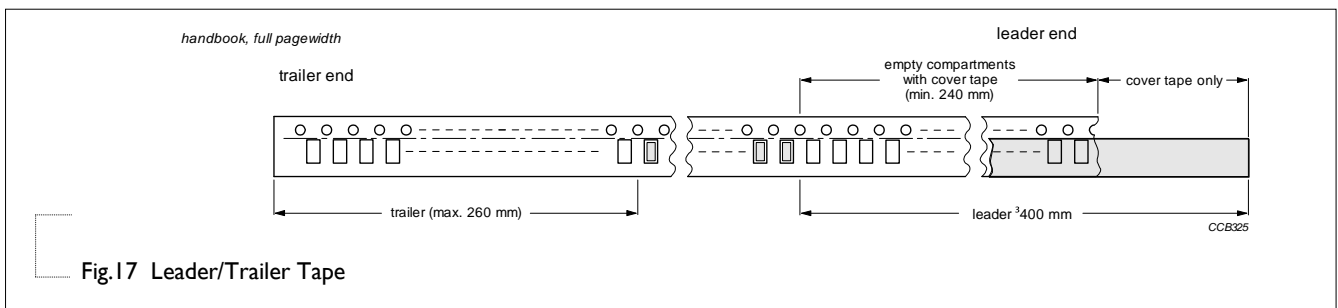

Fig. 17 Leader/Trailer Tape

FOOTPRINT AND SOLDERING PROFILES

For recommended soldering profiles, please refer to data sheet “Chip resistors mounting”.

FOOTPRINT

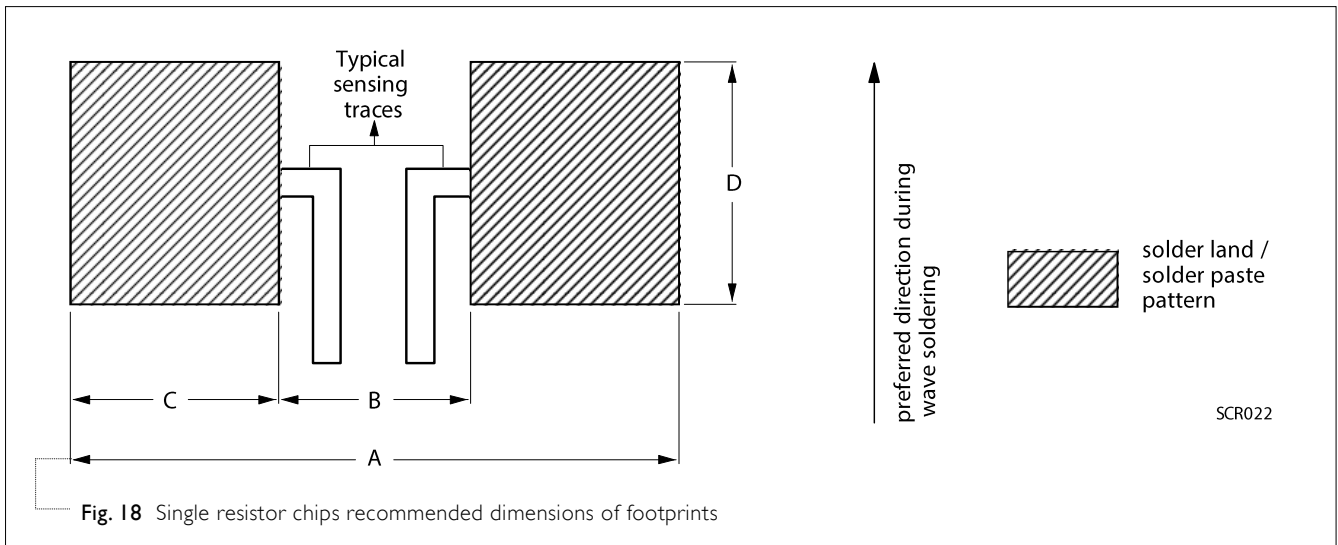

Table 7 Footprint dimensions

SIZE	RESISTANCE RANGE	Unit: mm			
		A	B	C	D
PE0100	100 mΩ ≤ R ≤ 1Ω	0.49~0.78	0.15~0.18	0.17~0.30	0.25~0.40
PE0201	50 mΩ ≤ R ≤ 910 mΩ	1.00	0.30	0.35	0.40
PE0402	10 mΩ ≤ R ≤ 910 mΩ	1.45	0.35	0.55	0.55
PE0603	5 mΩ ≤ R ≤ 910 mΩ	2.52	0.50	1.01	1.01
PE0805	5 mΩ ≤ R ≤ 910 mΩ	2.54	0.50	1.02	1.27
PE1206	5 mΩ ≤ R ≤ 910 mΩ	3.90	0.76	1.57	1.78
PE2010	5 mΩ ≤ R ≤ 6 mΩ	6.12	1.40	2.36	3.05
	7 mΩ ≤ R ≤ 910 mΩ	6.10	3.30	1.40	3.05
PE2512	6 mΩ	7.40	3.18	2.11	3.68
	7 mΩ ≤ R ≤ 910 mΩ	7.36	4.06	1.65	3.68
PE2817	20 mΩ ≤ R ≤ 910 mΩ	8.10	3.20	2.45	4.80
PE4527	5 mΩ	14.50	4.00	5.25	8.05
	6 mΩ ≤ R ≤ 120 mΩ	14.50	4.40	5.05	8.05

TESTS AND REQUIREMENTS

Table 8 Test condition, procedure and requirements

TEST	TEST METHOD	PROCEDURE	REQUIREMENTS
Life/ Operational Life/ Endurance	MIL-STD-202G-method 108 IEC 60115-1 4.25.1	1,000 hours at 70±2 °C applied RCWV 1.5 hours on, 0.5 hour off, still air required	0100 : ±(3%+0.0005 Ω) Others : ±(1%+0.0005 Ω)
High Temperature Exposure/ Endurance at Upper Category Temperature	MIL-STD-202G-method 108 IEC 60115-1 4.25.3	1,000 hours at maximum operating temperature depending on specification, unpowered No direct impingement of forced air to the parts Tolerances: 0100/0201/0402 125±3 °C 0603 and above 170±3 °C	0100 : ±(3%+0.0005 Ω) Others : ±(1%+0.0005 Ω)
Moisture Resistance	MIL-STD-202G-method 106	Each temperature / humidity cycle is defined at 8 hours (method 106F), 3 cycles / 24 hours for 10d with 25 °C / 65 °C 95% R.H, without steps 7a & 7b, unpowered Parts mounted on test-boards, without condensation on parts Measurement at 24±2 hours after test conclusion	0100/0201: ±(5%+0.0005 Ω) Others: ±(0.5%+0.0005 Ω)
Thermal Shock	MIL-STD-202G-method 107	-55/+125 °C Note: Number of cycles required is 300. Devices mounted Maximum transfer time is 20 seconds. Dwell time is 15 minutes. Air – Air	±(1%+0.0005 Ω)
Short Time Overload	IEC60115-1 4.13	5 times of rated power for 5 seconds at room temperature	0100 : ±(2%+0.0005 Ω) Others : ±(1%+0.0005 Ω) No visible damage
Board Flex/ Bending	IEC60115-1 4.33	Device mounted on PCB test board as described, only 1 board bending required Bending for 0100 : 5mm 0201: 3mm 0402 and above: 2mm Holding time: minimum 60 seconds	±(1%+0.0005 Ω) No visible damage
Biased Humidity	MIL-STD-202 Method 103	1,000 hours at 85°C/85%R.H. 10% of operating power, no condensation on the devices, circulating air.	0100/0201: ±(5%+0.0005 Ω) Others : ±(1.0%+0.0005 Ω)

TEST	TEST METHOD	PROCEDURE	REQUIREMENTS
Solderability - Wetting	IPC/JEDEC	Electrical Test not required	Well tinned ($\geq 95\%$ covered)
	J-STD-002B test B	Magnification 50X SMD conditions: 1 st step: method B, aging 4 hours at 155 °C dry heat 2 nd step: leadfree solder bath at 245±3 °C Dipping time: 3±0.5 seconds	No visible damage
- Leaching	IPC/JEDEC J-STD-002B test D	Leadfree solder, 260 °C, 30 seconds immersion time	No visible damage
- Resistance to Soldering Heat	MIL-STD-202G-method 210F	Condition B, no pre-heat of samples	0100 : $\pm(1\%+0.0005 \Omega)$
	IEC 60115-1 4.18	Leadfree solder, 260 °C, 10 seconds immersion time Procedure 2 for SMD: devices fluxed and cleaned with isopropanol	Others : $\pm(0.5\%+0.0005 \Omega)$ No visible damage

REVISION HISTORY

REVISION	DATE	CHANGE NOTIFICATION	DESCRIPTION
Version 10	Jan. 18, 2021	-	- Add rated power of PE2512 3W&5W - Add sizes of PE0100, PE2817 and PE4527
Version 9	Sep. 1, 2020	-	- Update dimensions of tape for PE0201 and PE1206
Version 8	Jun. 11, 2020	-	- Update the dimension for PE0805 5mohm & 6mohm - Update the marking for PE0603 - Extend resistance range for PE0201
Version 7	Jan. 21, 2019	-	- Extended resistor value for PE2010 and 2512
Version 6	Oct. 22, 2018	-	- Extend resistor value for PE0603 and 0805, and 0.1% tol for 0805 > 50mΩ - Add in pulse load behavior
Version 5	Nov 23, 2016	-	- Extend resistor value for 0.5%
Version 4	Dec. 21, 2015	-	- Update resistance value
Version 3	Aug. 06, 2015	-	- Update 0603 to 1206 TCR
Version 2	Apr. 20, 2015	-	- Extend resistor value
Version 1	Mar. 04, 2015	-	- Update TCR and operating temperature
Version 0	Feb. 10, 2015	-	- New datasheet for current sensor - low TCR PE series sizes of 0201/0402/0603/0805/1206/2010/2512, 0.5%, 1%, and 5%

“Yageo reserves all the rights for revising the content of this datasheet without further notification, as long as the products itself are unchanged. Any product change will be announced by PCN.”

X-ON Electronics

Largest Supplier of Electrical and Electronic Components

Click to view similar products for [Current Sense Resistors - SMD category](#):

Click to view products by [Yageo manufacturer](#):

Other Similar products are found below :

[CRL0603-FW-R700ELF](#) [PFS35-200RF1](#) [NPS 2-T126 5.000 OHM 1%](#) [PFS35-0R01J1](#) [PFS35-0R05J1](#) [PFS35-5RF1](#) [CD2015FC-0.10-1%](#)
[PR2512FKF7W0R004L](#) [RC1005F124CS](#) [RL73K3AR56JTDF](#) [RL7520WT-R001-F](#) [RL7520WT-R009-G](#) [RL7520WT-R020-F](#) [LRC-](#)
[LR2512LF-01-R820J](#) [WR06X104JGLJ](#) [TL2BR01F](#) [65709-330](#) [SP1R12J](#) [RL7520WT-R039-G](#) [RL7520WT-R002-F](#) [LRF2010-R003JW](#)
[KRL1632E-C-R200-F-T5](#) [KRL1632E-C-R200-F-T1](#) [RLP73M1ER051FTDF](#) [RLP73M2AR075FTDF](#) [SR731ERTTP5R10F](#) [SR731ERTTP100J](#)
[SR731ERTTP6R80F](#) [SR731ERTTP4R70F](#) [SR731ERTTP2R20F](#) [SR731ERTTP3R90F](#) [SR731ERTTP1R00F](#) [SR731ERTTP10R0F](#)
[SR731ERTTP2R00F](#) [SR731ERTTP8R20F](#) [SR731ERTTP3R9J](#) [SR731ERTTP8R2J](#) [SR731ERTTP2R0J](#) [SR731ERTTP4R7J](#)
[SR731ERTTP9R1J](#) [SR731ERTTP1R0J](#) [SR731ERTTP2R2J](#) [SR731ERTTP5R1J](#) [SR731ERTTP6R8J](#) [SR731ERTTP9R10F](#) [FCSL64R007JER](#)
[LRF1206-R018FW](#) [TLR2B10DR022FTDG](#) [TLR2H10DR01FTDG](#) [73L4R10G](#)