

## Transient Voltage Suppressors (TVS) Data Sheet

### Features

- Glass passivated junction
- Low inductance
- Excellent clamping capability
- 500W peak pulse power capability at 10/1000µs waveform, repetition rate (duty cycle): 0.01%
- Fast response time
- Typical  $I_R$  less than 1µA above 10V
- High Temperature soldering guaranteed: 265°C/10 seconds/.375", (9.5mm) lead length, 5lbs (2.3kg) tension
- Plastic package has underwriters laboratory flammability 94V-0
- Meets MSL level 1, per J-STD-020
- Safety certification: UL: E244458



### Mechanical Data

- Case: JEDEC DO-15 Moulded plastic
- Terminal: Axial leads, solderable per MIL-STD-750, Method 2026
- Polarity: Color band denotes cathode except bi-directional models
- Mounting Position: Any
- Weight: 0.42g

### Applications

- I/O interface
- AC/DC power supply
- Low frequency signal transmission line (RS232, RS485, etc.)

### Maximum Ratings and Characteristics

Ratings at 25°C ambient temperature unless otherwise specified.

Rating	Symbol	Value	Units
Peak pulse power dissipation at 10/1000µs waveform (Note1, Note2, Fig.1)	$P_{PPM}$	Minimum 500	Watts
Peak pulse current of at 10/1000µs waveform (Note 1, Fig.3)	$I_{PPM}$	See Table	Amps
Steady state power dissipation at $T_A=50^\circ\text{C}$ (Fig.5)	$P_{M(AV)}$	3.0	Watts
Peak forward surge current, 8.3ms single half sine-wave superimposed on rated load, (JEDEC Method) (Note3, Fig.6)	$I_{FSM}$	70	Amps
Operating junction and Storage Temperature Range.	$T_J, T_{STG}$	-55 to +150	°C
Typical thermal resistance junction to lead	$R_{\theta JL}$	20	°C/W
Typical thermal resistance junction to ambient	$R_{\theta JA}$	75	°C/W

Notes: 1. Non-repetitive current pulse, per Fig.3 and derated above  $T_A=25^\circ\text{C}$  per Fig.2.

2. 8.3ms single half sine-wave, or equivalent square wave, duty cycle=4 pulses per minutes maximum.

**Dimensions (DO-204AC/DO-15)**

	Symbol	Millimeters		Inches	
		Min.	Max.	Min.	Max.
L	25.40	-	1.000	-	
T	5.80	7.60	0.230	0.300	
d	2.60	3.60	0.104	0.140	
s	0.71	0.86	0.028	0.034	

**Electrical Characteristics (T<sub>A</sub>=25°C)**

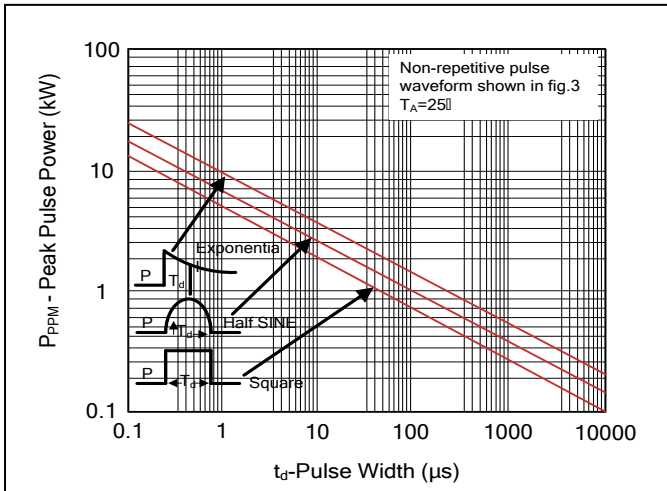
Part Number		Reverse Stand-Off Voltage	Breakdown Voltage @I <sub>T</sub>	Test Current	Maximum Clamping Voltage @I <sub>PP</sub>	Peak Pulse Current	Reverse Leakage @V <sub>RWM</sub>
Unidirectional	Bidirectional	V <sub>RWM</sub> (V)	V <sub>BR</sub> (V)	I <sub>T</sub> (mA)	V <sub>C</sub> (V)	I <sub>PP</sub> (A)	I <sub>R</sub> (μA)
SA5.0A	SA5.0CA	5.0	6.40~7.00	10	9.2	55.4	600
SA6.0A	SA6.0CA	6.0	6.67~7.37	10	10.3	49.5	600
SA6.5A	SA6.5CA	6.5	7.22~7.98	10	11.2	45.5	400
SA7.0A	SA7.0CA	7.0	7.78~8.60	10	12.0	42.5	150
SA7.5A	SA7.5CA	7.5	8.33~9.21	1	12.9	39.5	50
SA8.0A	SA8.0CA	8.0	8.89~9.83	1	13.6	37.5	25
SA8.5A	SA8.5CA	8.5	9.44~10.40	1	14.4	35.4	10
SA9.0A	SA9.0CA	9.0	10.00~11.10	1	15.4	33.1	5
SA10A	SA10CA	10.0	11.10~12.30	1	17.0	30.0	3
SA11A	SA11CA	11.0	12.20~13.50	1	18.2	28.0	1
SA12A	SA12CA	12.0	13.30~14.70	1	19.9	25.6	1
SA13A	SA13CA	13.0	14.40~15.90	1	21.5	23.7	1
SA14A	SA14CA	14.0	15.60~17.20	1	23.2	22.0	1
SA15A	SA15CA	15.0	16.70~18.50	1	24.4	20.9	1
SA16A	SA16CA	16.0	17.80~19.70	1	26.0	19.6	1
SA17A	SA17CA	17.0	18.90~20.90	1	27.6	18.5	1
SA18A	SA18CA	18.0	20.00~22.10	1	29.2	17.5	1
SA20A	SA20CA	20.0	22.20~24.50	1	32.4	15.7	1
SA22A	SA22CA	22.0	24.40~26.90	1	35.5	14.4	1
SA24A	SA24CA	24.0	26.70~29.50	1	38.9	13.1	1
SA26A	SA26CA	26.0	28.90~31.90	1	42.1	12.1	1
SA28A	SA28CA	28.0	31.10~34.40	1	45.4	11.2	1
SA30A	SA30CA	30.0	33.30~36.80	1	48.4	10.5	1

Part Number		Reverse Stand-Off Voltage	Breakdown Voltage @ $I_T$	Test Current	Maximum Clamping Voltage @ $I_{PP}$	Peak Pulse Current	Reverse Leakage @ $V_{RWM}$
Unidirectional	Bidirectional	$V_{RWM}(V)$	$V_{BR}(V)$	$I_T(mA)$	$V_C(V)$	$I_{PP}(A)$	$I_R(\mu A)$
SA33A	SA33CA	33.0	36.70~40.60	1	53.3	9.6	1
SA36A	SA36CA	36.0	40.00~44.20	1	58.1	8.8	1
SA40A	SA40CA	40.0	44.40~49.10	1	64.5	7.9	1
SA43A	SA43CA	43.0	47.80~52.80	1	69.4	7.3	1
SA45A	SA45CA	45.0	50.00~55.30	1	72.7	7.0	1
SA48A	SA48CA	48.0	53.30~58.90	1	77.4	6.6	1
SA51A	SA51CA	51.0	56.70~62.70	1	82.4	6.2	1
SA54A	SA54CA	54.0	60.00~66.30	1	87.1	5.9	1
SA58A	SA58CA	58.0	64.40~71.20	1	93.6	5.4	1
SA60A	SA60CA	60.0	66.70~73.70	1	96.8	5.3	1
SA64A	SA64CA	64.0	71.10~78.60	1	103.0	5.0	1
SA70A	SA70CA	70.0	77.80~86.00	1	113.0	4.5	1
SA75A	SA75CA	75.0	83.30~92.10	1	121.0	4.2	1
SA78A	SA78CA	78.0	86.70~95.80	1	126.0	4.0	1
SA85A	SA85CA	85.0	94.40~104.00	1	137.0	3.7	1
SA90A	SA90CA	90.0	100.00~111.00	1	146.0	3.5	1
SA100A	SA100CA	100.0	111.00~123.00	1	162.0	3.1	1
SA110A	SA110CA	110.0	122.00~135.00	1	177.0	2.9	1
SA120A	SA120CA	120.0	133.00~147.00	1	193.0	2.6	1
SA130A	SA130CA	130.0	144.00~159.00	1	209.0	2.4	1
SA150A	SA150CA	150.0	167.00~185.00	1	243.0	2.1	1
SA160A	SA160CA	160.0	178.00~197.00	1	259.0	2.0	1
SA170A	SA170CA	170.0	189.00~209.00	1	275.0	1.9	1
SA180A	SA180CA	180.0	201.00~222.00	1	292.0	1.7	1
SA190A	SA190CA	190.0	211.00~233.00	1	308.0	1.6	1
SA200A	SA200CA	200.0	224.00~247.00	1	324.0	1.5	1
SA210A	SA210CA	210.0	237.00~263.00	1	340.0	1.5	1
SA220A	SA220CA	220.0	246.00~272.00	1	356.0	1.4	1

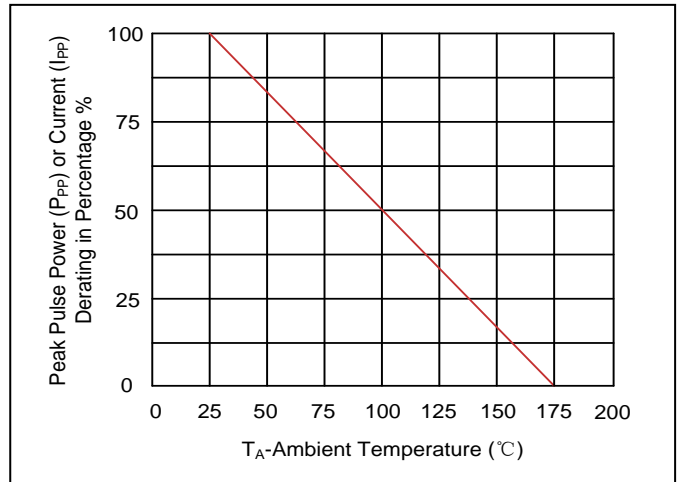
Notes: For bidirectional type having  $V_{RWM}$  of 10V and less, the  $I_R$  limit is double.

**Ratings and Characteristic Curves ( $T_A=25^\circ\text{C}$  unless otherwise noted)**

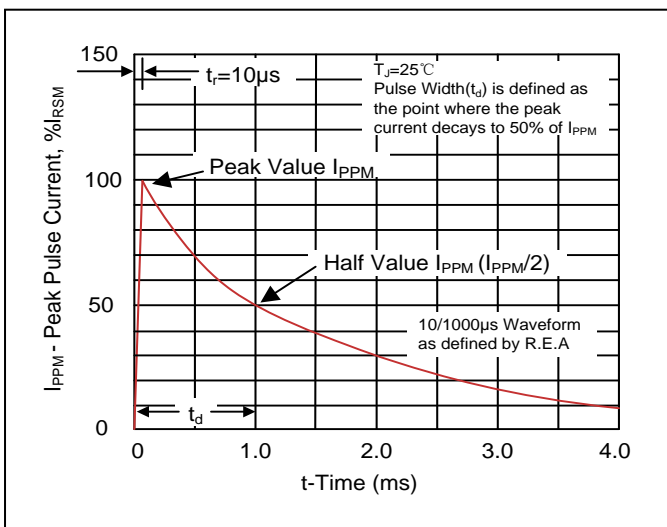
**Figure 1. Peak Pulse Power Rating Curve**



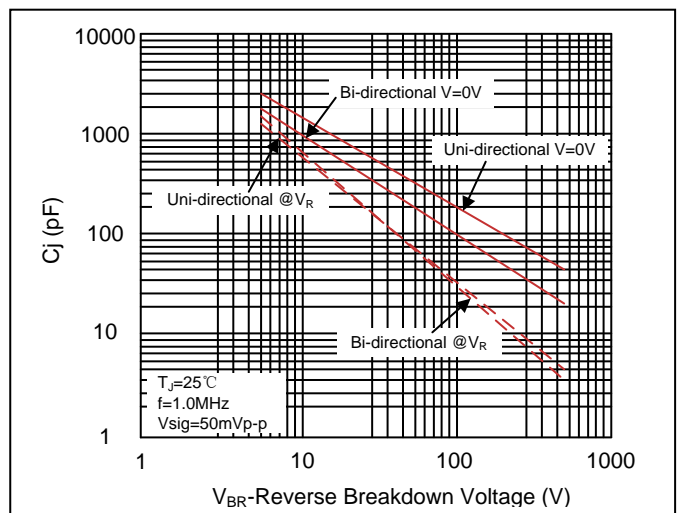
**Figure 2. Pulse Derating Curve**



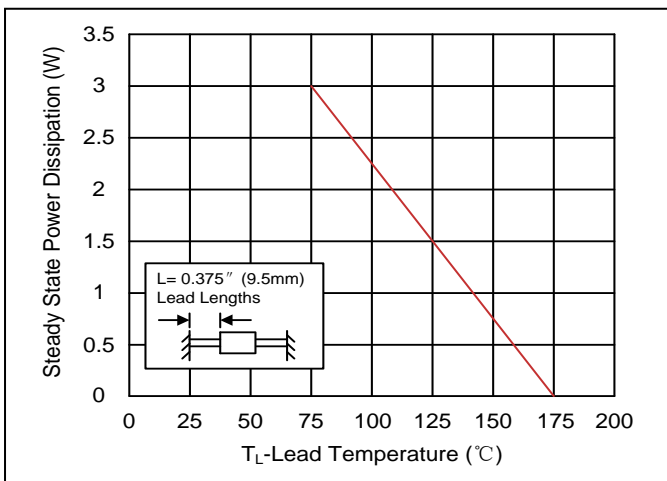
**Figure 3. Pulse Waveform**



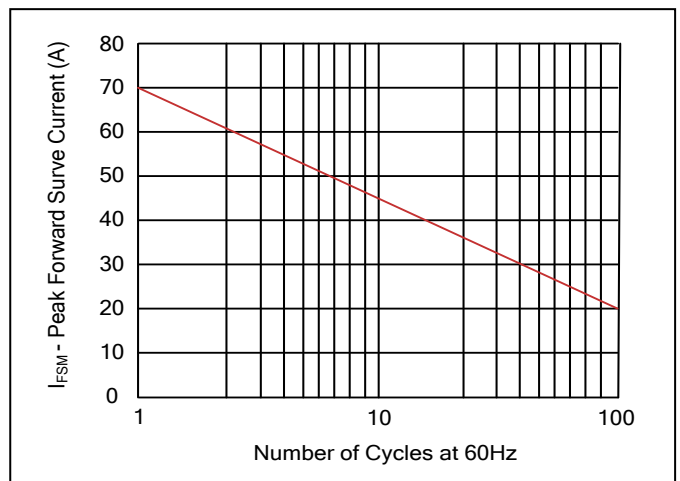
**Figure 4. Typical Junction Capacitance**



**Figure 5. Steady State Power Dissipation Derating Curve**

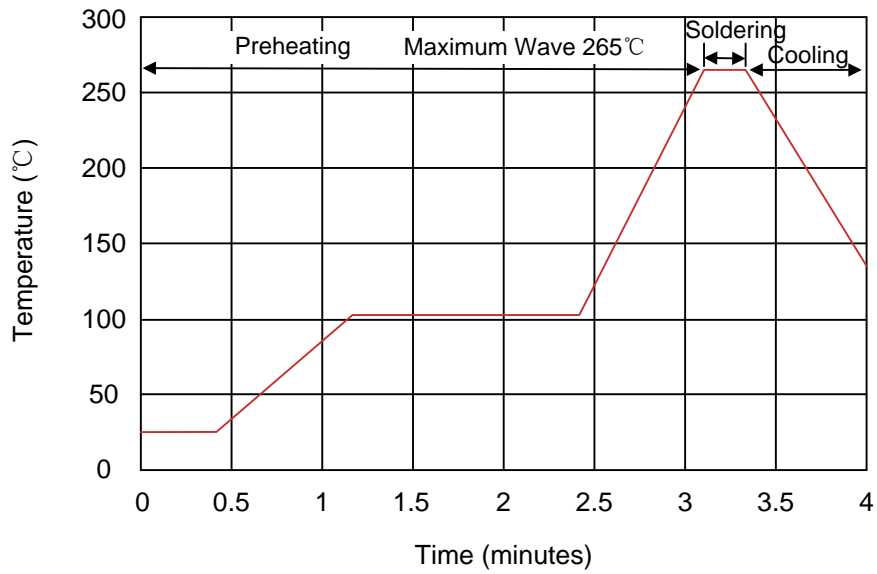


**Figure 6. Maximum Non-Repetitive Forward Surge Current Uni-Directional Only**



## Recommended Soldering Conditions

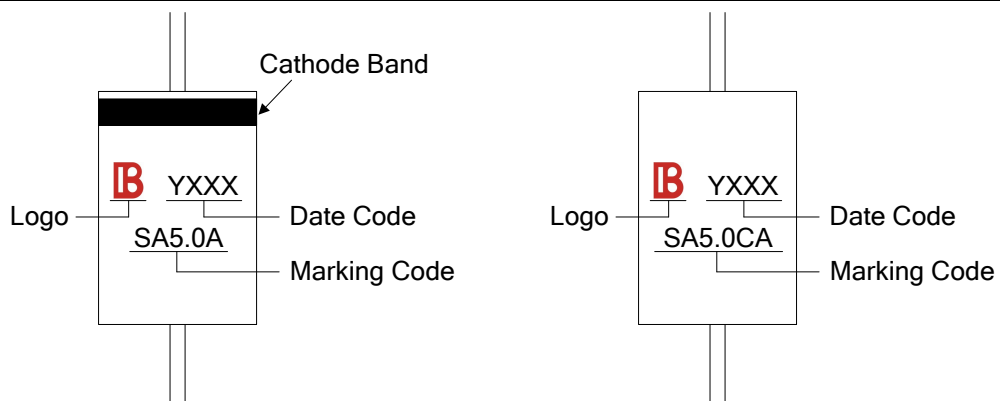
### Wave Soldering



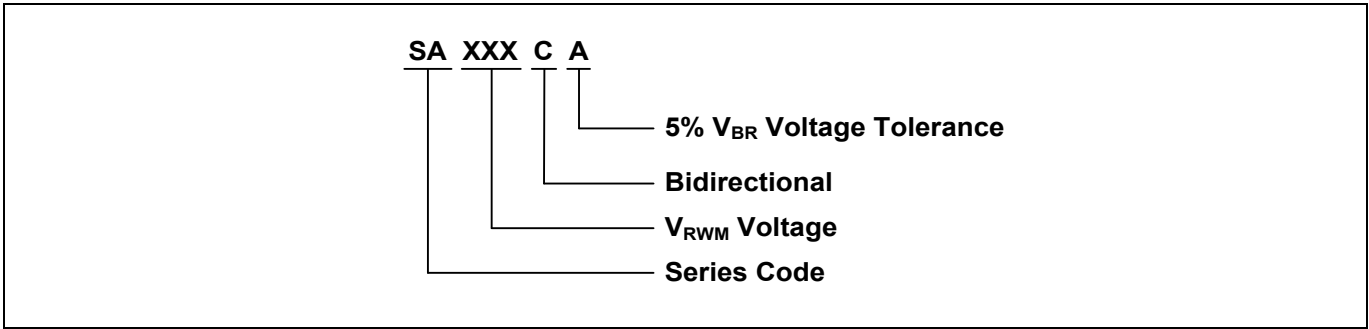
### Recommended Conditions

Item	Conditions
Peak Temperature	265°C
Dipping Time	10 seconds
Soldering	1 time

## Marking Code



**Part Number Code**



**Ordering Code for Different Package**

Box package: Add suffix "/B" at the end of the part number, such as SA7.0A/B

Reel package: Add suffix "/TR13" at the end of the part number, such as SA15CA/TR13

**Packaging**

Tape		Symbol	Dimension (mm)
		A	5.0±0.5
		B	53.0±1.0
		Z	1.2Max.
		T	6.0±0.4
		E	0.8Max.
		L1-L2	1.0Max.
		Box	
		W	75.0±5.0
		H	114.0±5.0
		Quantity: 2000PCS	
Reel		D	330.0±3.0
		D0	16.4±2.0
		D1	86.0±2.0
		W1	76.0±3.0
		Quantity: 4000PCS	

## X-ON Electronics

Largest Supplier of Electrical and Electronic Components

*Click to view similar products for [ESD Suppressors / TVS Diodes](#) category:*

*Click to view products by [Yageo](#) manufacturer:*

Other Similar products are found below :

[60KS200C](#) [D18V0L1B2LP-7B](#) [D5V0F4U5P5-7](#) [DESD5V0U1BB-7](#) [NTE4902](#) [P4KE27CA](#) [P6KE11CA](#) [P6KE39CA-TP](#) [P6KE8.2A](#)  
[SA110CA](#) [SA60CA](#) [SA64CA](#) [SMBJ12CATR](#) [SMBJ33CATR](#) [SMBJ8.0A](#) [ESD101-B1-02ELS E6327](#) [ESD105-B1-02EL E6327](#) [ESD112-B1-02EL E6327](#) [ESD119B1W01005E6327XTSA1](#) [ESD5V0L1B02VH6327XTSA1](#) [ESD7451N2T5G](#) [19180-510](#) [CPDT-5V0USP-HF](#)  
[3.0SMCJ33CA-F](#) [3.0SMCJ36A-F](#) [HSPC16701B02TP](#) [D3V3Q1B2DLP3-7](#) [D55V0M1B2WS-7](#) [DESD5V0U1BL-7B](#) [DRTR5V0U4SL-7](#)  
[SCM1293A-04SO](#) [ESD200-B1-CSP0201 E6327](#) [SM12-7](#) [SMF8.0A-TP](#) [SMLJ45CA-TP](#) [SMQA1000T1G](#) [CEN955 W/DATA](#) [82350120560](#)  
[VESD12A1A-HD1-GS08](#) [CPDUR5V0R-HF](#) [CPDQC5V0U-HF](#) [CPDQC5V0USP-HF](#) [CPDQC5V0-HF](#) [IP4042CX5/LF,135](#) [D1213A-01LP4-7B](#) [D1213A-02WL-7](#) [1SMB33CAT3G-XYZ](#) [MMAD1108/TR13](#) [5KP100A](#) [5KP15A](#)