

Transient Voltage Suppressors (TVS) Data Sheet

Features

- For surface mounted applications in order to optimize board space
- Low profile package
- Built-in strain relief
- Glass passivated junction
- Low inductance
- Excellent clamping capability
- 600W peak pulse power capability at 10/1000 μ s waveform, repetition rate (duty cycle): 0.01%
- Fast response time
- Typical I_R less than 1 μ A above 10V
- High Temperature soldering: 260 $^{\circ}$ C/10 seconds at terminals
- Plastic package has underwriters laboratory flammability 94V-0
- Meets MSL level 1, per J-STD-020
- Safety certification: UL: E244458
- AEC-Q101 qualified (SMBJ8.0~SMBJ440)

Mechanical Data

- Case: JEDEC DO-214AA. Molded plastic over glass passivated junction
- Terminal: Solder plated, solderable per MIL-STD-750, Method 2026
- Polarity: Color band denotes cathode except bi-directional models
- Standard Packaging: 12mm tape (EIA STD RS-481)
- Weight: 0.10g

Applications

- I/O interface
- AC/DC power supply
- Low frequency signal transmission line (RS232, RS485, etc.)

Maximum Ratings and Characteristics

Ratings at 25 $^{\circ}$ C ambient temperature unless otherwise specified.

Rating	Symbol	Value	Units
Peak pulse power dissipation at 10/1000 μ s waveform (Note1, Note2, Fig.1)	P_{PPM}	Minimum 600	Watts
Peak pulse current of at 10/1000 μ s waveform (Note 1, Fig.3)	I_{PPM}	See Table	Amps
Steady state power dissipation at $T_A=50^{\circ}$ C (Fig.5)	$P_{M(AV)}$	5.0	Watts
Peak forward surge current, 8.3ms single half sine-wave superimposed on rated load, (JEDEC Method) (Note3, Fig.6)	I_{FSM}	100	Amps
Operating junction and Storage Temperature Range.	T_J, T_{STG}	-65 to +150	$^{\circ}$ C
Typical thermal resistance junction to lead	$R_{\theta JL}$	20	$^{\circ}$ C/W
Typical thermal resistance junction to ambient	$R_{\theta JA}$	100	$^{\circ}$ C/W

Notes: 1. Non-repetitive current pulse, per Fig.3 and derated above $T_A=25^{\circ}$ C per Fig.2.

2. Mounted on 5.0mm \times 5.0mm (0.03mm thick) copper pads to each terminal.

3. 8.3ms single half sine-wave, or equivalent square wave, duty cycle=4 pulses per minutes maximum.

Dimensions (SMB/DO-214AA)

	Symbol	Millimeters		Inches	
		Min.	Max.	Min.	Max.
	L	4.06	4.57	0.160	0.180
	D	3.30	3.94	0.130	0.155
	D1	1.95	2.20	0.077	0.086
	T	5.21	5.59	0.205	0.220
	T1	0.76	1.52	0.030	0.060
	d	-	0.203	-	0.008
	H	2.15	2.65	0.085	0.104
	H1	2.13	2.47	0.084	0.097

Electrical Characteristics ($T_A=25^\circ\text{C}$)

Part Number		Device Marking Code		Reverse Stand-Off Voltage	Breakdown Voltage @ I_T	Test Current	Maximum Clamping Voltage @ I_{PP}	Peak Pulse Current	Reverse Leakage @ V_{RWM}
Unidirectional	Bidirectional	UNI	BI	$V_{RWM}(V)$	$V_{BR}(V)$	$I_T(mA)$	$V_C(V)$	$I_{PP}(A)$	$I_R(\mu A)$
SMBJ5.0A	SMBJ5.0CA	KE	AE	5.0	6.40~7.00	10	9.2	65.3	800
SMBJ6.0A	SMBJ6.0CA	KG	AG	6.0	6.67~7.37	10	10.3	58.3	800
SMBJ6.5A	SMBJ6.5CA	KK	AK	6.5	7.22~7.98	10	11.2	53.6	500
SMBJ7.0A	SMBJ7.0CA	KM	AM	7.0	7.78~8.60	10	12.0	50.0	200
SMBJ7.5A	SMBJ7.5CA	KP	AP	7.5	8.33~9.21	1	12.9	46.6	100
SMBJ8.0A	SMBJ8.0CA	KR	AR	8.0	8.89~9.83	1	13.6	44.2	50
SMBJ8.5A	SMBJ8.5CA	KT	AT	8.5	9.44~10.40	1	14.4	41.7	20
SMBJ9.0A	SMBJ9.0CA	KV	AV	9.0	10.00~11.10	1	15.4	39.0	10
SMBJ10A	SMBJ10CA	KX	AX	10.0	11.10~12.30	1	17.0	35.3	5
SMBJ11A	SMBJ11CA	KZ	AZ	11.0	12.20~13.50	1	18.2	33.0	1
SMBJ12A	SMBJ12CA	LE	BE	12.0	13.30~14.70	1	19.9	30.2	1
SMBJ13A	SMBJ13CA	LG	BG	13.0	14.40~15.90	1	21.5	28.0	1
SMBJ14A	SMBJ14CA	LK	BK	14.0	15.60~17.20	1	23.2	25.9	1
SMBJ15A	SMBJ15CA	LM	BM	15.0	16.70~18.50	1	24.4	24.6	1
SMBJ16A	SMBJ16CA	LP	BP	16.0	17.80~19.70	1	26.0	23.1	1
SMBJ17A	SMBJ17CA	LR	BR	17.0	18.90~20.90	1	27.6	21.8	1
SMBJ18A	SMBJ18CA	LT	BT	18.0	20.00~22.10	1	29.2	20.6	1
SMBJ20A	SMBJ20CA	LV	BV	20.0	22.20~24.50	1	32.4	18.6	1
SMBJ22A	SMBJ22CA	LX	BX	22.0	24.40~26.90	1	35.5	16.9	1
SMBJ24A	SMBJ24CA	LZ	BZ	24.0	26.70~29.50	1	38.9	15.5	1

Electrical Characteristics ($T_A=25^{\circ}\text{C}$)

Part Number		Device Marking Code		Reverse Stand-Off Voltage	Breakdown Voltage @ I_T	Test Current	Maximum Clamping Voltage @ I_{PP}	Peak Pulse Current	Reverse Leakage @ V_{RWM}
Unidirectional	Bidirectional	UNI	BI	$V_{RWM}(V)$	$V_{BR}(V)$	$I_T(mA)$	$V_C(V)$	$I_{PP}(A)$	$I_R(\mu A)$
SMBJ26A	SMBJ26CA	ME	CE	26.0	28.90~31.90	1	42.1	14.3	1
SMBJ28A	SMBJ28CA	MG	CG	28.0	31.10~34.40	1	45.4	13.3	1
SMBJ30A	SMBJ30CA	MK	CK	30.0	33.30~36.80	1	48.4	12.4	1
SMBJ33A	SMBJ33CA	MM	CM	33.0	36.70~40.60	1	53.3	11.3	1
SMBJ36A	SMBJ36CA	MP	CP	36.0	40.00~44.20	1	58.1	10.4	1
SMBJ40A	SMBJ40CA	MR	CR	40.0	44.40~49.10	1	64.5	9.3	1
SMBJ43A	SMBJ43CA	MT	CT	43.0	47.80~52.80	1	69.4	8.7	1
SMBJ45A	SMBJ45CA	MV	CV	45.0	50.00~55.30	1	72.7	8.3	1
SMBJ48A	SMBJ48CA	MX	CX	48.0	53.30~58.90	1	77.4	7.8	1
SMBJ51A	SMBJ51CA	MZ	CZ	51.0	56.70~62.70	1	82.4	7.3	1
SMBJ54A	SMBJ54CA	NE	DE	54.0	60.00~66.30	1	87.1	6.9	1
SMBJ58A	SMBJ58CA	NG	DG	58.0	64.40~71.20	1	93.6	6.5	1
SMBJ60A	SMBJ60CA	NK	DK	60.0	66.70~73.70	1	96.8	6.2	1
SMBJ64A	SMBJ64CA	NM	DM	64.0	71.10~78.60	1	103.0	5.9	1
SMBJ70A	SMBJ70CA	NP	DP	70.0	77.80~86.00	1	113.0	5.3	1
SMBJ75A	SMBJ75CA	NR	DR	75.0	83.30~92.10	1	121.0	5.0	1
SMBJ78A	SMBJ78CA	NT	DT	78.0	86.70~95.80	1	126.0	4.8	1
SMBJ85A	SMBJ85CA	NV	DV	85.0	94.40~104.00	1	137.0	4.4	1
SMBJ90A	SMBJ90CA	NX	DX	90.0	100.00~111.00	1	146.0	4.1	1
SMBJ100A	SMBJ100CA	NZ	DZ	100.0	111.00~123.00	1	162.0	3.7	1
SMBJ110A	SMBJ110CA	PE	EE	110.0	122.00~135.00	1	177.0	3.4	1
SMBJ120A	SMBJ120CA	PG	EG	120.0	133.00~147.00	1	193.0	3.1	1
SMBJ130A	SMBJ130CA	PK	EK	130.0	144.00~159.00	1	209.0	2.9	1
SMBJ150A	SMBJ150CA	PM	EM	150.0	167.00~185.00	1	243.0	2.5	1
SMBJ160A	SMBJ160CA	PP	EP	160.0	178.00~197.00	1	259.0	2.3	1
SMBJ170A	SMBJ170CA	PR	ER	170.0	189.00~209.00	1	275.0	2.2	1
SMBJ180A	SMBJ180CA	PT	ET	180.0	201.00~222.00	1	292.0	2.1	1
SMBJ190A	SMBJ190CA	PA	EC	190.0	211.00~233.00	1	308.0	2.0	1
SMBJ200A	SMBJ200CA	PV	EV	200.0	224.00~247.00	1	324.0	1.9	1
SMBJ210A	SMBJ210CA	PB	ED	210.0	237.00~263.00	1	340.0	1.8	1
SMBJ220A	SMBJ220CA	PX	EX	220.0	246.00~272.00	1	356.0	1.7	1
SMBJ250A	SMBJ250CA	PZ	EZ	250.0	279.00~309.00	1	405.0	1.5	1
SMBJ300A	SMBJ300CA	QE	FE	300.0	335.00~371.00	1	486.0	1.3	1
SMBJ350A	SMBJ350CA	QG	FG	350.0	391.00~432.00	1	567.0	1.1	1
SMBJ400A	SMBJ400CA	QK	FK	400.0	447.00~494.00	1	648.0	0.9	1
SMBJ440A	SMBJ440CA	QM	FM	440.0	492.00~543.00	1	713.0	0.9	1

Notes: For bidirectional type having V_{RWM} of 10V and less, the I_R limit is double.

Ratings and Characteristic Curves ($T_A=25^\circ\text{C}$ unless otherwise noted)

Figure 1. Peak Pulse Power Rating Curve

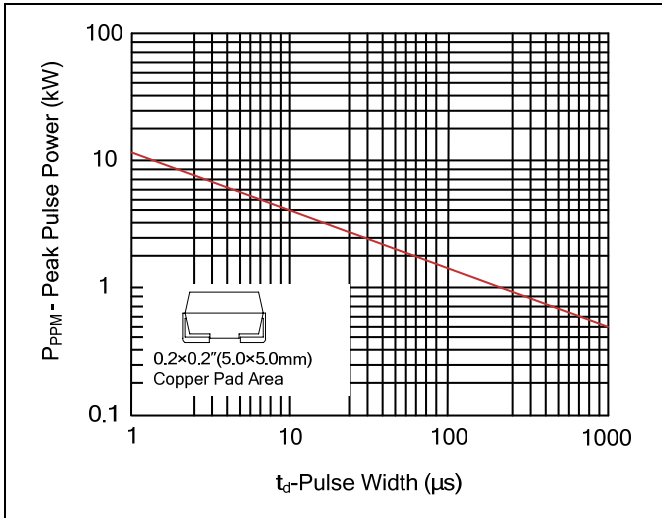

Figure 2. Pulse Derating Curve

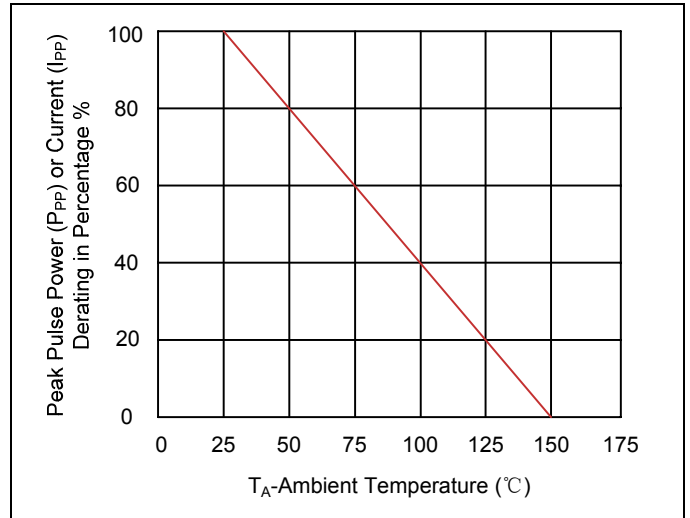

Figure 3. Pulse Waveform

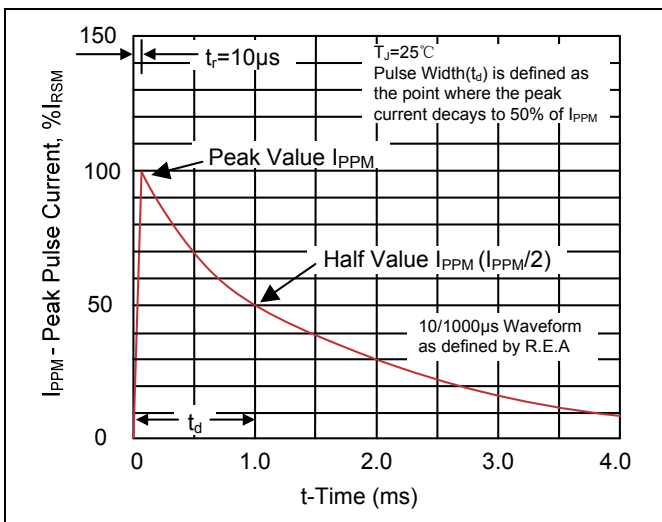

Figure 4. Typical Junction Capacitance

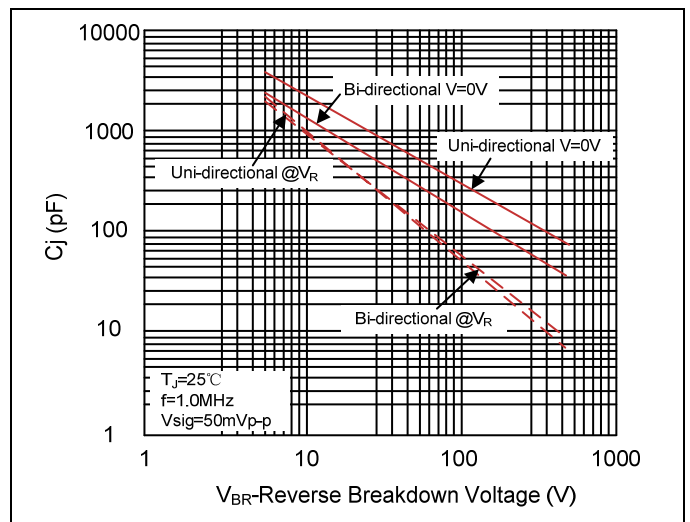

Figure 5. Steady State Power Dissipation Derating Curve

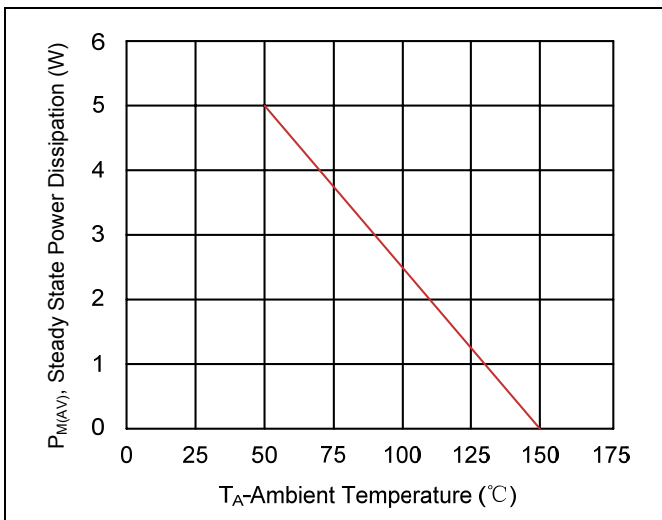
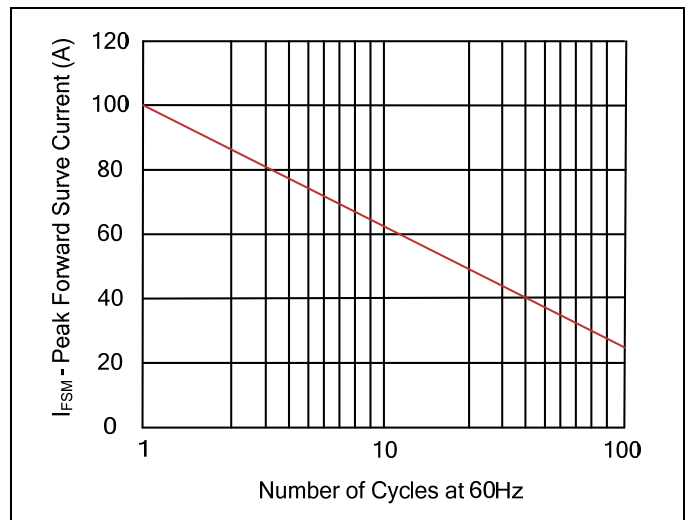

Figure 6. Maximum Non-Repetitive Forward Surge Current Uni-Directional Only



Recommended Soldering Conditions



Recommended Conditions

Profile Feature	Pb-Free Assembly
Average ramp-up rate (T_L to T_P)	3°C/second max.
Preheat -Temperature Min ($T_{S\ min}$) -Temperature Max ($T_{S\ max}$) -Time (min to max) (t_s)	150°C 200°C 60-180 seconds
$T_{S\ max}$ to T_L -Ramp-up Rate	3°C/second max.
Time maintained above: -Temperature (T_L) -Time (t_L)	217°C 60-150 seconds
Peak Temperature (T_P)	260°C
Time within 5°C of actual Peak Temperature (t_P)	20-40 seconds
Ramp-down Rate	6°C/second max.
Time 25°C to Peak Temperature	8 minutes max.

Marking Code

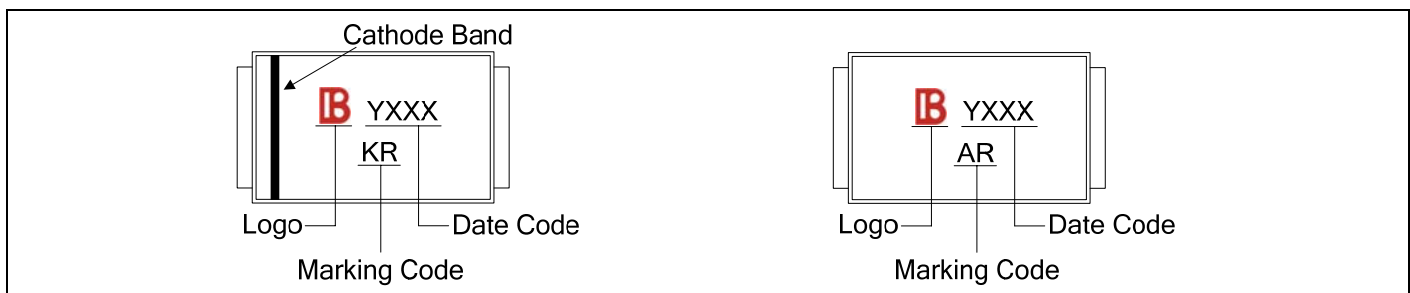

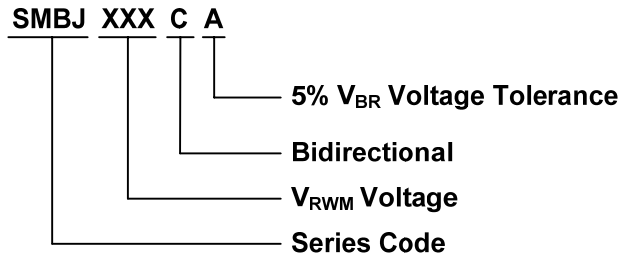

Packaging

Tape		Symbol	Dimension (mm)		
		W	12.00±0.20		
		P0	4.00±0.10		
		P1	8.00±0.10		
		P2	2.00±0.10		
		D0	Φ1.55±0.10		
		D1	Φ1.5±0.10		
		E	1.75±0.10		
		F	5.50±0.10		
		A0	3.86±0.15		
		B0	5.65±0.10		
		K0	2.75±0.15		
		T	0.25±0.05		
		7" Reel		D2	Φ178.0±2.0
				D3	Φ50.0Min.
D4	Φ13.0±0.5				
W1	16.0±2.0				
Quantity: 500PCS					
13" Reel				D5	Φ330.0±2.0
		D6	Φ13.5±0.5		
		H	2.5±1.0		
		W2	16.0±2.0		
		Quantity: 3000PCS			

X-ON Electronics

Largest Supplier of Electrical and Electronic Components

Click to view similar products for [ESD Suppressors / TVS Diodes](#) category:

Click to view products by [Yageo](#) manufacturer:

Other Similar products are found below :

[60KS200C](#) [D18V0L1B2LP-7B](#) [D5V0F4U5P5-7](#) [DESD5V0U1BB-7](#) [NTE4902](#) [P4KE27CA](#) [P6KE11CA](#) [P6KE39CA-TP](#) [P6KE8.2A](#)
[SA110CA](#) [SA60CA](#) [SA64CA](#) [SMBJ12CATR](#) [SMBJ33CATR](#) [SMBJ8.0A](#) [ESD101-B1-02ELS E6327](#) [ESD105-B1-02EL E6327](#) [ESD112-B1-02EL E6327](#) [ESD119B1W01005E6327XTSA1](#) [ESD5V0L1B02VH6327XTSA1](#) [ESD7451N2T5G](#) [19180-510](#) [CPDT-5V0USP-HF](#)
[3.0SMCJ33CA-F](#) [3.0SMCJ36A-F](#) [HSPC16701B02TP](#) [D3V3Q1B2DLP3-7](#) [D55V0M1B2WS-7](#) [DESD5V0U1BL-7B](#) [DRTR5V0U4SL-7](#)
[SCM1293A-04SO](#) [ESD200-B1-CSP0201 E6327](#) [SM12-7](#) [SMF8.0A-TP](#) [SMLJ45CA-TP](#) [CEN955 W/DATA](#) [82350120560](#) [VESD12A1A-](#)
[HD1-GS08](#) [CPDUR5V0R-HF](#) [CPDQC5V0U-HF](#) [CPDQC5V0USP-HF](#) [CPDQC5V0-HF](#) [D1213A-01LP4-7B](#) [D1213A-02WL-7](#)
[MMAD1108/TR13](#) [5KP100A](#) [5KP15A](#) [5KP18A](#) [5KP48A](#) [5KP90A](#)