

Transient Voltage Suppressors (TVS) Data Sheet

Features

- For surface mounted applications in order to optimize board space
- Low profile package
- Built-in strain relief
- Glass passivated junction
- Low inductance
- Excellent clamping capability
- 1500W peak pulse power capability at 10/1000μs waveform, repetition rate (duty cycle): 0.01%
- Fast response time
- Typical I_R less than 1μA above 10V
- High Temperature soldering: 260°C/10 seconds at terminals
- Plastic package has underwriters laboratory flammability 94V-0
- Meets MSL level 1, per J-STD-020
- Safety certification: UL: E244458
- AEC-Q101 qualified



Mechanical Data

- Case: JEDEC DO-214AB. Molded plastic over glass passivated junction
- Terminal: Solder plated, solderable per MIL-STD-750, Method 2026
- Polarity: Color band denotes cathode except bi-directional models
- Standard Packaging: 16mm tape (EIA STD RS-481)
- Weight: 0.26g

Applications

- I/O interface
- AC/DC power supply
- Low frequency signal transmission line (RS232, RS485, etc.)

Maximum Ratings and Characteristics

Ratings at 25°C ambient temperature unless otherwise specified.

Rating	Symbol	Value	Units
Peak pulse power dissipation at 10/1000μs waveform (Note1, Note2, Fig.1)	P_{PPM}	Minimum 1500	Watts
Peak pulse current of at 10/1000μs waveform (Note 1, Fig.3)	I_{PPM}	See Table	Amps
Steady state power dissipation at $T_A=50^\circ\text{C}$ (Fig.5)	$P_{M(AV)}$	6.5	Watts
Peak forward surge current, 8.3ms single half sine-wave superimposed on rated load, (JEDEC Method) (Note3, Fig.6)	I_{FSM}	200	Amps
Operating junction and Storage Temperature Range.	T_J, T_{STG}	-55 to +150	°C
Typical thermal resistance junction to lead	$R_{\theta JL}$	15	°C/W
Typical thermal resistance junction to ambient	$R_{\theta JA}$	75	°C/W

Notes: 1. Non-repetitive current pulse, per Fig.3 and derated above $T_A=25^\circ\text{C}$ per Fig.2.

2. Mounted on 8.0mm×8.0mm copper pads to each terminal.

3. 8.3ms single half sine-wave, or equivalent square wave, duty cycle=4 pulses per minutes maximum.

Dimensions (SMC/DO-214AB)

	Symbol	Millimeters		Inches	
		Min.	Max.	Min.	Max.
L	6.60	7.11	0.260	0.280	
D	5.59	6.22	0.220	0.245	
D1	2.90	3.20	0.114	0.126	
T	7.75	8.13	0.305	0.320	
T1	0.76	1.52	0.030	0.060	
d	-	0.203	-	0.008	
H	2.20	2.80	0.087	0.110	
H1	2.06	2.62	0.079	0.103	

Electrical Characteristics (T_A=25°C)

Part Number		Device Marking Code		Reverse Stand-Off Voltage	Breakdown Voltage @ I _T	Test Current	Maximum Clamping Voltage @ I _{PP}	Peak Pulse Current	Reverse Leakage @ V _{RWM}
Unidirectional	Bidirectional	UNI	BI	V _{RWM} (V)	V _{BR} (V)	I _T (mA)	V _C (V)	I _{PP} (A)	I _R (μA)
SMCJ5.0A-AT	SMCJ5.0CA-AT	GDE	BDE	5.0	6.40~7.00	10	9.2	163.0	800
SMCJ6.0A-AT	SMCJ6.0CA-AT	GDG	BDG	6.0	6.67~7.37	10	10.3	145.7	800
SMCJ6.5A-AT	SMCJ6.5CA-AT	GDK	BDK	6.5	7.22~7.98	10	11.2	134.0	500
SMCJ7.0A-AT	SMCJ7.0CA-AT	GDM	BDM	7.0	7.78~8.60	10	12.0	125.0	200
SMCJ7.5A-AT	SMCJ7.5CA-AT	GDP	BDP	7.5	8.33~9.21	1	12.9	116.3	100
SMCJ8.0A-AT	SMCJ8.0CA-AT	GDR	BDR	8.0	8.89~9.83	1	13.6	110.3	50
SMCJ8.5A-AT	SMCJ8.5CA-AT	GDT	BDT	8.5	9.44~10.40	1	14.4	104.2	20
SMCJ9.0A-AT	SMCJ9.0CA-AT	GDV	BDV	9.0	10.00~11.10	1	15.4	97.4	10
SMCJ10A-AT	SMCJ10CA-AT	GDY	BDY	10.0	11.10~12.30	1	17.0	88.3	5
SMCJ11A-AT	SMCJ11CA-AT	GDZ	BDZ	11.0	12.20~13.50	1	18.2	82.5	1
SMCJ12A-AT	SMCJ12CA-AT	GEE	BEE	12.0	13.30~14.70	1	19.9	75.4	1
SMCJ13A-AT	SMCJ13CA-AT	GEG	BEG	13.0	14.40~15.90	1	21.5	69.8	1
SMCJ14A-AT	SMCJ14CA-AT	GEK	BEK	14.0	15.60~17.20	1	23.2	64.7	1
SMCJ15A-AT	SMCJ15CA-AT	GEM	BEM	15.0	16.70~18.50	1	24.4	61.5	1
SMCJ16A-AT	SMCJ16CA-AT	GEP	BEP	16.0	17.80~19.70	1	26.0	57.7	1
SMCJ17A-AT	SMCJ17CA-AT	GER	BER	17.0	18.90~20.90	1	27.6	54.4	1
SMCJ18A-AT	SMCJ18CA-AT	GET	BET	18.0	20.00~22.10	1	29.2	51.4	1
SMCJ20A-AT	SMCJ20CA-AT	GEV	BEV	20.0	22.20~24.50	1	32.4	46.3	1
SMCJ22A-AT	SMCJ22CA-AT	GEX	BEX	22.0	24.40~26.90	1	35.5	42.3	1
SMCJ24A-AT	SMCJ24CA-AT	GEZ	BEZ	24.0	26.70~29.50	1	38.9	38.6	1

Part Number		Device Marking Code		Reverse Stand-Off Voltage	Breakdown Voltage @ I_T	Test Current	Maximum Clamping Voltage @ I_{PP}	Peak Pulse Current	Reverse Leakage @ V_{RWM}
Unidirectional	Bidirectional	UNI	BI	$V_{RWM}(V)$	$V_{BR}(V)$	$I_T(mA)$	$V_C(V)$	$I_{PP}(A)$	$I_R(\mu A)$
SMCJ26A-AT	SMCJ26CA-AT	GFE	BFE	26.0	28.90~31.90	1	42.1	35.7	1
SMCJ28A-AT	SMCJ28CA-AT	GFG	BFG	28.0	31.10~34.40	1	45.4	33.1	1
SMCJ30A-AT	SMCJ30CA-AT	GFK	BFK	30.0	33.30~36.80	1	48.4	31.0	1
SMCJ33A-AT	SMCJ33CA-AT	GFM	BFM	33.0	36.70~40.60	1	53.3	28.2	1
SMCJ36A-AT	SMCJ36CA-AT	GFP	BFP	36.0	40.00~44.20	1	58.1	25.9	1
SMCJ40A-AT	SMCJ40CA-AT	GFR	BFR	40.0	44.40~49.10	1	64.5	23.3	1
SMCJ43A-AT	SMCJ43CA-AT	GFT	BFT	43.0	47.80~52.80	1	69.4	21.7	1
SMCJ45A-AT	SMCJ45CA-AT	GFV	BFV	45.0	50.00~55.30	1	72.7	20.6	1
SMCJ48A-AT	SMCJ48CA-AT	GFX	BFX	48.0	53.30~58.90	1	77.4	19.4	1
SMCJ51A-AT	SMCJ51CA-AT	GFZ	BFZ	51.0	56.70~62.70	1	82.4	18.2	1
SMCJ54A-AT	SMCJ54CA-AT	GGE	BGE	54.0	60.00~66.30	1	87.1	17.3	1
SMCJ58A-AT	SMCJ58CA-AT	GGG	BGG	58.0	64.40~71.20	1	93.6	16.1	1
SMCJ60A-AT	SMCJ60CA-AT	GGK	BGK	60.0	66.70~73.70	1	96.8	15.5	1
SMCJ64A-AT	SMCJ64CA-AT	GGM	BGM	64.0	71.10~78.60	1	103.0	14.6	1
SMCJ70A-AT	SMCJ70CA-AT	GGP	BGP	70.0	77.80~86.00	1	113.0	13.3	1
SMCJ75A-AT	SMCJ75CA-AT	GGR	BGR	75.0	83.30~92.10	1	121.0	12.4	1
SMCJ78A-AT	SMCJ78CA-AT	GGT	BGT	78.0	86.70~95.80	1	126.0	11.9	1
SMCJ85A-AT	SMCJ85CA-AT	GGV	BGV	85.0	94.40~104.00	1	137.0	11.0	1
SMCJ90A-AT	SMCJ90CA-AT	GGX	BGX	90.0	100.00~111.00	1	146.0	10.3	1
SMCJ100A-AT	SMCJ100CA-AT	GGZ	BGZ	100.0	111.00~123.00	1	162.0	9.3	1
SMCJ110A-AT	SMCJ110CA-AT	GHE	BHE	110.0	122.00~135.00	1	177.0	8.5	1
SMCJ120A-AT	SMCJ120CA-AT	GHG	BHG	120.0	133.00~147.00	1	193.0	7.8	1
SMCJ130A-AT	SMCJ130CA-AT	GHK	BHK	130.0	144.00~159.00	1	209.0	7.2	1
SMCJ150A-AT	SMCJ150CA-AT	GHM	BHM	150.0	167.00~185.00	1	243.0	6.2	1
SMCJ160A-AT	SMCJ160CA-AT	GHP	BHP	160.0	178.00~197.00	1	259.0	5.8	1
SMCJ170A-AT	SMCJ170CA-AT	GHR	BHR	170.0	189.00~209.00	1	275.0	5.5	1
SMCJ180A-AT	SMCJ180CA-AT	GHT	BHT	180.0	201.00~222.00	1	292.0	5.1	1
SMCJ190A-AT	SMCJ190CA-AT	GHU	BHU	190.0	211.00~233.00	1	308.0	4.8	1
SMCJ200A-AT	SMCJ200CA-AT	GHV	BHV	200.0	224.00~247.00	1	324.0	4.6	1
SMCJ210A-AT	SMCJ210CA-AT	GHW	BHW	210.0	237.00~263.00	1	340.0	4.4	1
SMCJ220A-AT	SMCJ220CA-AT	GHX	BHX	220.0	246.00~272.00	1	356.0	4.2	1
SMCJ250A-AT	SMCJ250CA-AT	GHZ	BHZ	250.0	279.00~309.00	1	405.0	3.7	1
SMCJ300A-AT	SMCJ300CA-AT	GJE	BJE	300.0	335.00~371.00	1	486.0	3.1	1
SMCJ350A-AT	SMCJ350CA-AT	GJG	BJG	350.0	391.00~432.00	1	567.0	2.6	1
SMCJ400A-AT	SMCJ400CA-AT	GJK	BJK	400.0	447.00~494.00	1	648.0	2.3	1
SMCJ440A-AT	SMCJ440CA-AT	GJM	BJM	440.0	492.00~543.00	1	713.0	2.1	1

Notes: For bidirectional type having V_{RWM} of 10V and less, the I_R limit is double.

Ratings and Characteristic Curves ($T_A=25^\circ\text{C}$ unless otherwise noted)

Figure 1. Peak Pulse Power Rating Curve

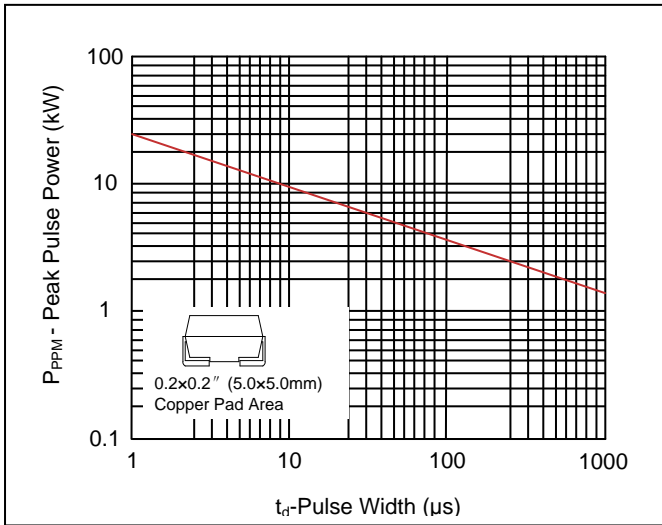

Figure 2. Pulse Derating Curve

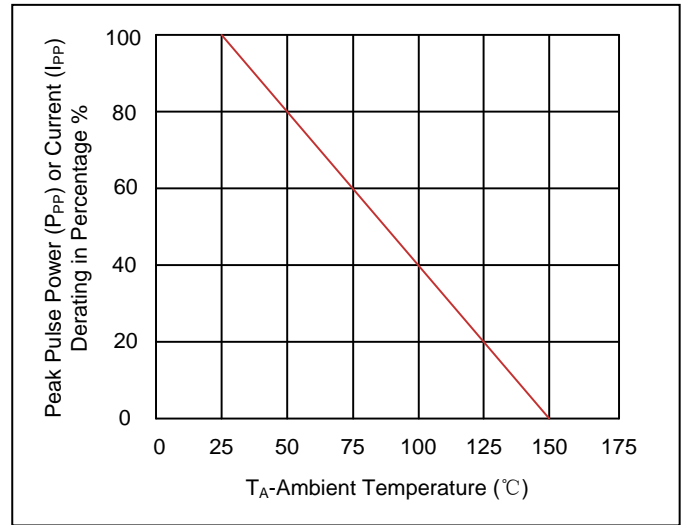

Figure 3. Pulse Waveform

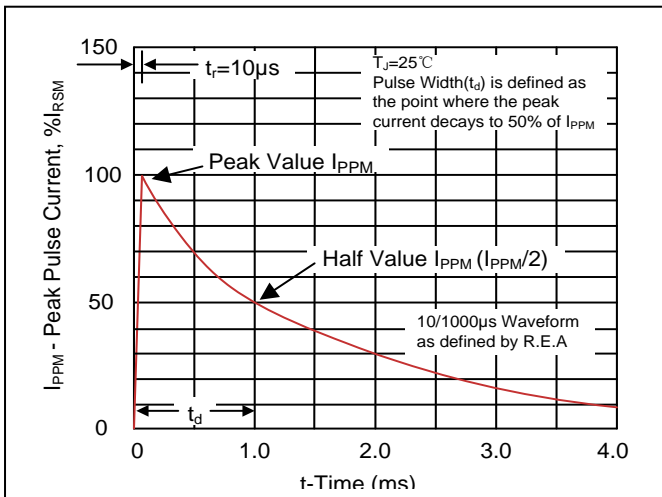

Figure 4. Typical Junction Capacitance

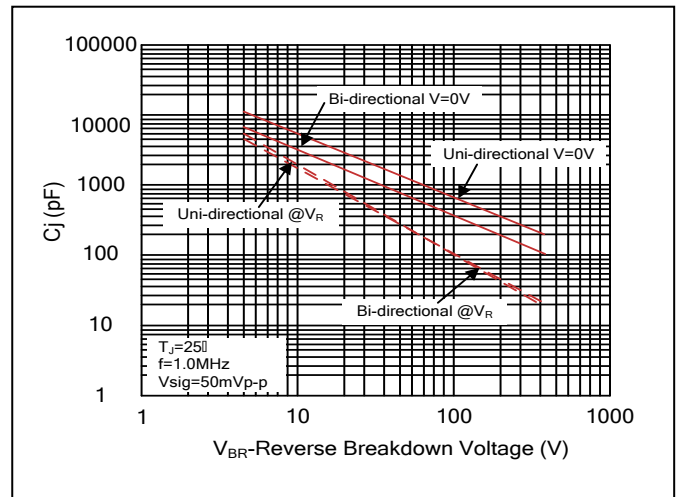

Figure 5. Steady State Power Dissipation Derating Curve

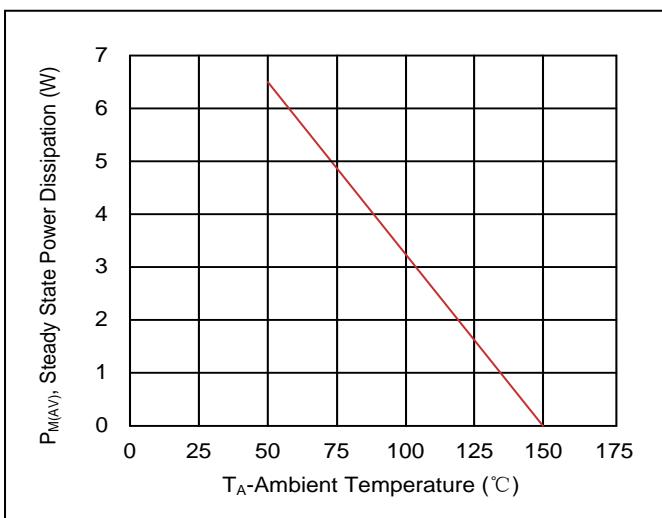
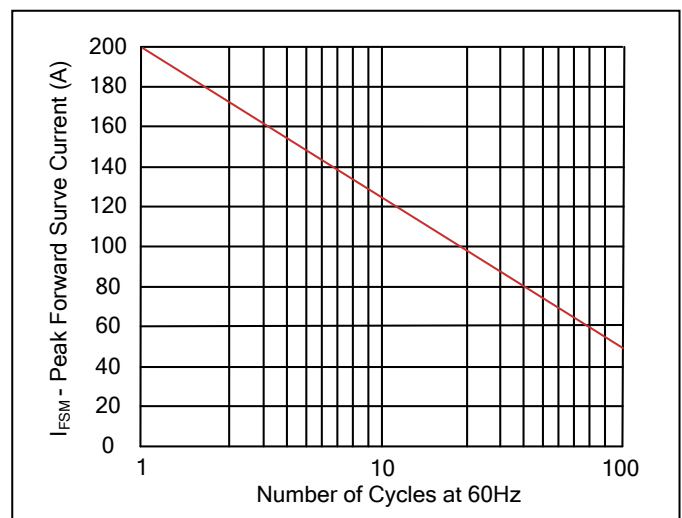
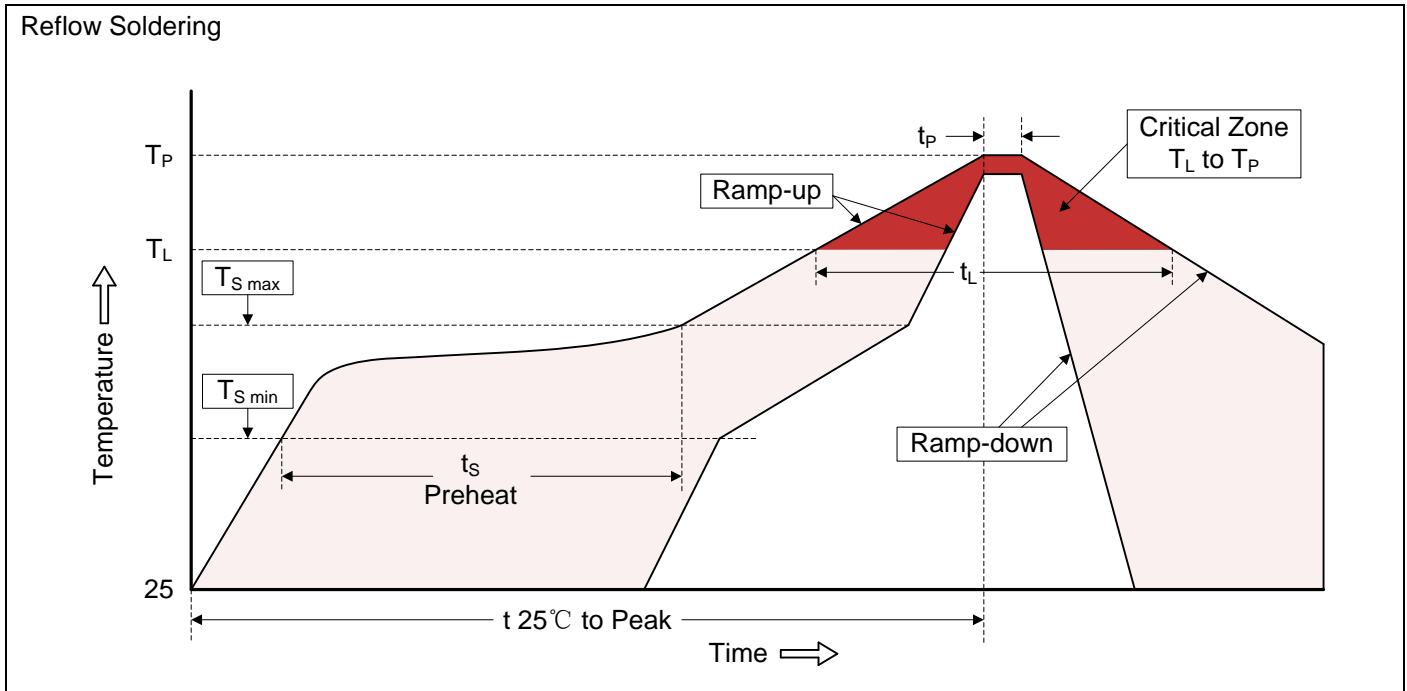

Figure 6. Maximum Non-Repetitive Forward Surge Current Uni-Directional Only



Recommended Soldering Conditions



Recommended Conditions

Profile Feature	Pb-Free Assembly
Average ramp-up rate (T_L to T_P)	3°C/second max.
Preheat -Temperature Min ($T_{S\ min}$) -Temperature Max ($T_{S\ max}$) -Time (min to max) (t_s)	150°C 200°C 60-180 seconds
$T_{S\ max}$ to T_L -Ramp-up Rate	3°C/second max.
Time maintained above: -Temperature (T_L) -Time (t_L)	217°C 60-150 seconds
Peak Temperature (T_P)	260°C
Time within 5°C of actual Peak Temperature (t_p)	20-40 seconds
Ramp-down Rate	6°C/second max.
Time 25°C to Peak Temperature	8 minutes max.

Marking Code

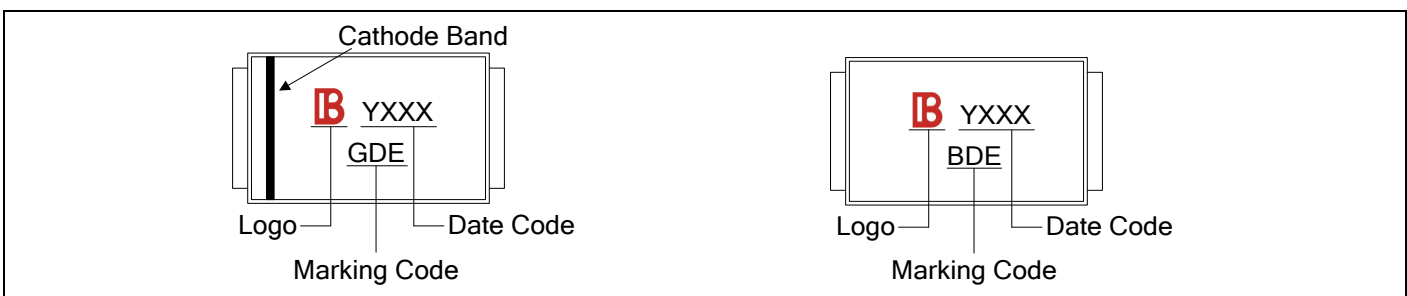

Part Number Code

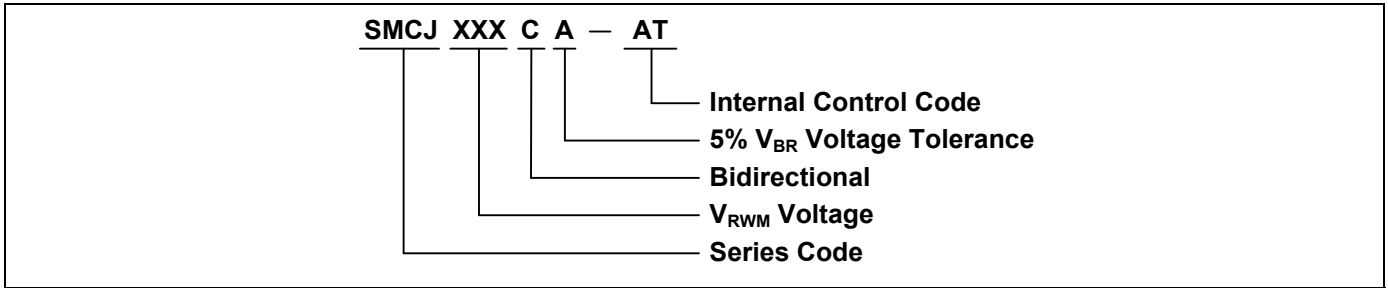

Ordering Code for Different Package

7 inch reel package: Add suffix "/TR7" at the end of the part number, such as SMCJ75A-AT/TR7

13 inch reel package: Add suffix "/TR13" at the end of the part number, such as SMCJ200CA-AT/TR13

Packaging

Tape		Symbol	Dimension (mm)
		W	16.00±0.20
		P0	4.00±0.10
		P1	8.00±0.10
		P2	2.00±0.10
		D0	Φ1.5 ±0.10
		D1	Φ1.5 ±0.10
		E	1.75±0.10
		F	7.50±0.10
		A0	6.27±0.15
		B0	8.30±0.10
		K0	3.15±0.15
		T	0.30±0.05
		<p>7" Reel</p>	
D3	Φ50.0Min.		
D4	Φ13.0±0.5		
W1	20.0 ±2.0		
Quantity: 500PCS			
<p>13" Reel</p>		D5	Φ330.0±2.0
		D6	Φ13.5±0.5
		H	2.5±1.0
		W2	20.0±2.0
		Quantity: 3000PCS	

X-ON Electronics

Largest Supplier of Electrical and Electronic Components

Click to view similar products for [ESD Suppressors / TVS Diodes](#) category:

Click to view products by [Yageo](#) manufacturer:

Other Similar products are found below :

[D18V0L1B2LP-7B](#) [D5V0F4U5P5-7](#) [NTE4902](#) [P4KE27CA](#) [P6KE11CA](#) [P6KE8.2A](#) [SA60CA](#) [SA64CA](#) [SMBJ12CATR](#) [SMBJ33CATR](#)
[SMBJ8.0A](#) [ESD101-B1-02ELS E6327](#) [ESD112-B1-02EL E6327](#) [ESD7451N2T5G](#) [19180-510](#) [CPDT-5V0USP-HF](#) [3.0SMCJ33CA-F](#)
[3.0SMCJ36A-F](#) [HSPC16701B02TP](#) [JANTX1N6126A](#) [JANTX1N6173A](#) [JANTX1N6465](#) [D3V3Q1B2DLP3-7](#) [D55V0M1B2WS-7](#)
[DRTR5V0U4SL-7](#) [SCM1293A-04SO](#) [ESD200-B1-CSP0201 E6327](#) [SM12-7](#) [SMQA1000T1G](#) [CEN955 W/DATA](#) [VESD12A1A-HD1-GS08](#)
[CPDUR5V0R-HF](#) [CPDQC5V0-HF](#) [IP4042CX5/LF,135](#) [D1213A-01LP4-7B](#) [1SMB33CAT3G-XYZ](#) [ESD101-B1-02EL E6327](#) [AOZ8808DI-](#)
[03](#) [5KP15A](#) [5KP48A](#) [5KP90A](#) [ESD3V3D7-TP](#) [ESDAVLC12-1BV2](#) [15KPA36A-LF](#) [NTE4900](#) [P4KE56CA](#) [P4KE68A](#) [P4KE91CATR](#)
[P6KE120A](#) [P6KE13CA](#)