

# SSL04LP Series

## SMD Power Inductors

### APPLICATIONS

Notebook Computers, Step-up and Step-down Converters

Flash Memory Programmers, etc.

### FEATURES

High Energy Storage and Very Low Resistance

Smallest Size and High Performance

### ELECTRICAL CHARACTERISTICS

PART NO.	INDUCTANCE * ( $\mu$ H)	TOLERANCE ( $\pm$ %)	DC RESISTANCE ( $\Omega$ ) Max.	Isat ** (A)	Irms *** (A)
SSL04LP-1R2M-N	1.2	20	0.08	2.10	3.60
SSL04LP-1R5M-N	1.5	20	0.10	1.90	2.80
SSL04LP-2R2M-N	2.2	20	0.12	1.60	2.40
SSL04LP-3R3M-N	3.3	20	0.16	1.30	2.00
SSL04LP-4R7M-N	4.7	20	0.20	1.10	1.70
SSL04LP-6R8M-N	6.8	20	0.32	0.90	1.20
SSL04LP-100M-N	10	20	0.41	0.80	1.10
SSL04LP-150M-N	15	20	0.55	0.65	0.90
SSL04LP-220M-N	22	20	0.85	0.50	0.83
SSL04LP-330M-N	33	20	1.30	0.40	0.62
SSL04LP-470M-N	47	20	1.80	0.35	0.52
SSL04LP-680M-N	68	20	2.50	0.30	0.35
SSL04LP-101M-N	100	20	3.50	0.25	0.27
SSL04LP-151M-N	150	20	5.00	0.18	0.24
SSL04LP-221M-N	220	20	7.00	0.16	0.23
SSL04LP-331M-N	330	20	15.0	0.13	0.13

Note:

\*Inductance Tested at 100 KHz, 0.1 Vrms.

\*\*\* $\Delta$ T = 40 °C Rise Typ at Irms.

\*\*Inductance Drop = 10% Typ. at Isat.

Operating Temperature Range: -40 °C to +85 °C



### PRODUCT IDENTIFICATION

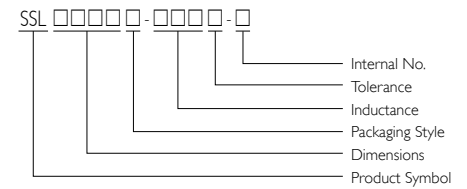

■ Packaging: T = Tape and Reel, B = Bulk

■ Internal No.: N = Lead-Free

### SHAPES AND DIMENSIONS

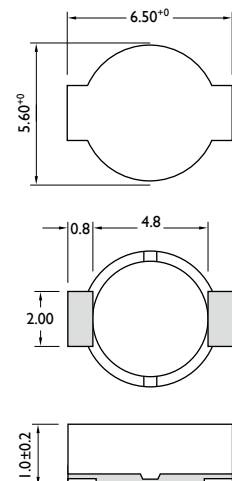

Dimensions: mm

## SMD Power Inductors

## SSL0400 Series



## PRODUCT IDENTIFICATION

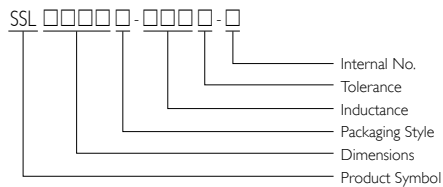

- Packaging: T = Tape and Reel, B = Bulk
- Internal No.: N = Lead-Free

## SHAPES AND DIMENSIONS

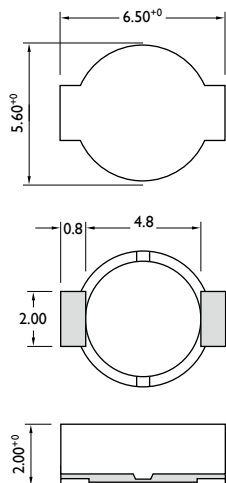

Dimensions: mm

## APPLICATIONS

Notebook Computers, Step-up and Step-down Converters

Flash Memory Programmers, etc.

## FEATURES

High Energy Storage and Very Low Resistance

Smallest Size and High Performance

## ELECTRICAL CHARACTERISTICS

PART NO.	INDUCTANCE * ( $\mu$ H)	TOLERANCE ( $\pm$ %)	DC RESISTANCE ( $\Omega$ ) Max.	Isat ** (A)	Irms *** (A)
SSL0400T-1R0M-N	1.0	20	0.05	2.50	2.30
SSL0400T-1R5M-N	1.5	20	0.06	2.20	2.10
SSL0400T-2R2M-N	2.2	20	0.07	1.80	1.70
SSL0400T-3R3M-N	3.3	20	0.12	1.40	1.30
SSL0400T-4R7M-N	4.7	20	0.15	1.20	1.10
SSL0400T-6R8M-N	6.8	20	0.20	1.10	1.00
SSL0400T-100M-N	10	20	0.30	1.00	0.90
SSL0400T-150M-N	15	20	0.40	0.80	0.70
SSL0400T-220M-N	22	20	0.54	0.60	0.50
SSL0400T-330M-N	33	20	0.74	0.50	0.45
SSL0400T-470M-N	47	20	1.10	0.45	0.40
SSL0400T-680M-N	68	20	1.60	0.35	0.35
SSL0400T-101M-N	100	20	2.30	0.30	0.30
SSL0400T-151M-N	150	20	3.50	0.25	0.25
SSL0400T-221M-N	220	20	5.70	0.20	0.18
SSL0400T-331M-N	330	20	8.20	0.16	0.16
SSL0400T-471M-N	470	20	10.8	0.14	0.12
SSL0400T-681M-N	680	20	17.2	0.12	0.10
SSL0400T-102M-N	1000	20	22.6	0.08	0.08

Note:

\*Inductance Tested at 100 KHz, 0.1 Vrms.

\*\*\* $\Delta$ T = 40 °C Rise Typ at Irms.

\*\*Inductance Drop = 10% Typ. at Isat.

Operating Temperature Range: -40 °C to +85 °C

# SSL0402 Series

## SMD Power Inductors

### APPLICATIONS

Notebook Computers, Step-up and Step-down Converters

Flash Memory Programmers, etc.

### FEATURES

High Energy Storage and Very Low Resistance

Smallest Size and High Performance

### ELECTRICAL CHARACTERISTICS

PART NO.	INDUCTANCE *	TOLERANCE	SRF	DC RESISTANCE		Isat **	I <sub>rms</sub> ***
	( $\mu$ H)	( $\pm$ %)		(MHz) Typ.	( $\Omega$ ) Max.		
SSL0402T-1R0M-N	1.0	20	130	0.05	2.90	2.90	
SSL0402T-1R5M-N	1.5	20	115	0.05	2.60	2.80	
SSL0402T-2R2M-N	2.2	20	90	0.07	2.30	2.40	
SSL0402T-3R3M-N	3.3	20	70	0.08	2.00	2.00	
SSL0402T-4R7M-N	4.7	20	50	0.09	1.50	1.50	
SSL0402T-6R8M-N	6.8	20	45	0.13	1.20	1.40	
SSL0402T-100M-N	10	20	35	0.16	1.10	1.10	
SSL0402T-150M-N	15	20	30	0.23	0.90	1.20	
SSL0402T-220M-N	22	20	20	0.37	0.70	0.80	
SSL0402T-330M-N	33	20	15	0.51	0.58	0.60	
SSL0402T-470M-N	47	20	14	0.64	0.50	0.50	
SSL0402T-680M-N	68	20	11	0.86	0.40	0.40	
SSL0402T-101M-N	100	20	9.0	1.27	0.31	0.30	
SSL0402T-151M-N	150	20	6.0	2.00	0.27	0.25	
SSL0402T-221M-N	220	20	5.5	3.11	0.22	0.20	
SSL0402T-331M-N	330	20	5.0	3.80	0.18	0.16	
SSL0402T-471M-N	470	20	4.0	5.06	0.16	0.15	
SSL0402T-681M-N	680	20	3.0	9.20	0.14	0.12	
SSL0402T-102M-N	1000	20	2.0	13.8	0.10	0.07	

Note:

\*Inductance Tested at 100 KHz, 0.1 Vrms.

\*\*\* $\Delta$ T = 30 °C Rise Typ at I<sub>rms</sub>.

\*\*Inductance Drop = 20% Typ. at Isat.

Operating Temperature Range: -40 °C to +85 °C



### PRODUCT IDENTIFICATION

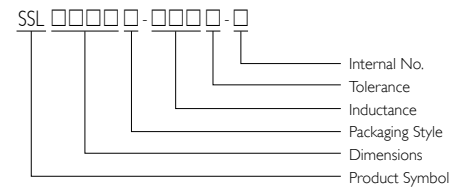

■ Packaging: T = Tape and Reel, B = Bulk

■ Internal No.: N = Lead-Free

### SHAPES AND DIMENSIONS

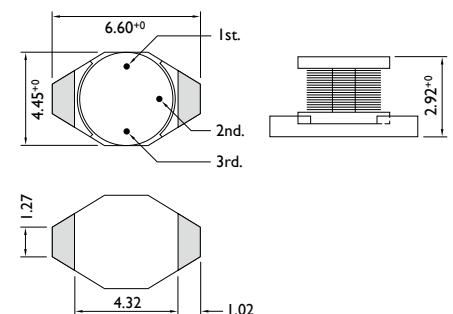

Dimensions: mm

## SMD Power Inductors

## SSL0614 Series



## PRODUCT IDENTIFICATION

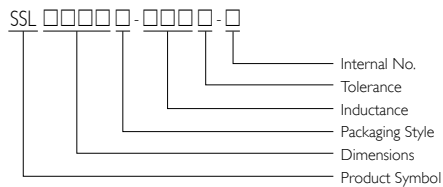

- Packaging: T = Tape and Reel, B = Bulk
- Internal No.: N = Lead-Free

## SHAPES AND DIMENSIONS

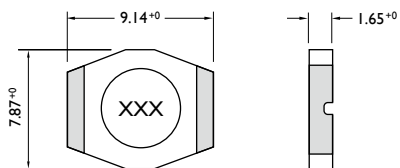

Dimensions: mm

## APPLICATIONS

Notebook Computers, Step-up and Step-down Converters

Flash Memory Programmers, etc.

## FEATURES

High Energy Storage and Very Low Resistance

Smallest Size and High Performance

## ELECTRICAL CHARACTERISTICS

PART NO.	INDUCTANCE * ( $\mu$ H)	TOLERANCE ( $\pm$ %)	DC RESISTANCE ( $\Omega$ ) Max.	I <sub>rms</sub> ** (A)
SSL0614T-4R7M-N	4.7	20	0.145	1.60
SSL0614T-6R8M-N	6.8	20	0.165	1.30
SSL0614T-100M-N	10	20	0.240	1.00
SSL0614T-150M-N	15	20	0.300	0.90
SSL0614T-220M-N	22	20	0.420	0.70
SSL0614T-330M-N	33	20	0.550	0.60
SSL0614T-470M-N	47	20	0.765	0.40
SSL0614T-680M-N	68	20	1.10	0.40
SSL0614T-101M-N	100	20	1.60	0.30
SSL0614T-151M-N	150	20	2.50	0.25
SSL0614T-221M-N	220	20	3.65	0.22
SSL0614T-331M-N	330	20	4.65	0.18
SSL0614T-471M-N	470	20	6.75	0.14
SSL0614T-681M-N	680	20	9.15	0.12
SSL0614T-102M-N	1000	20	14.2	0.10

Note:

\*Inductance Tested at 100 KHz, 0.1 Vrms.

\*\*Inductance Drop = 10% Typ. at Isat.

Operating Temperature Range: -40 °C to +85 °C

# SSL0802 Series

## SMD Power Inductors

### APPLICATIONS

Notebook Computers, Step-up and Step-down Converters

Flash Memory Programmers, etc.

### FEATURES

High Energy Storage and Very Low Resistance

Smallest Size and High Performance

### ELECTRICAL CHARACTERISTICS

PART NO.	INDUCTANCE * ( $\mu\text{H}$ )	TOLERANCE ( $\pm\%$ )	SRF (MHz) Typ.	DC RESISTANCE ( $\Omega$ ) Max.	Isat ** (A)	Irms *** (A)
SSL0802T-100M-N	10	20	35	0.09	2.40	2.00
SSL0802T-150M-N	15	20	33	0.12	2.00	1.50
SSL0802T-220M-N	22	20	25	0.19	1.60	1.30
SSL0802T-330M-N	33	20	19	0.25	1.40	1.10
SSL0802T-470M-N	47	20	14	0.32	1.00	0.80
SSL0802T-680M-N	68	20	12	0.55	0.90	0.70
SSL0802T-101M-N	100	20	10	0.70	0.70	0.60
SSL0802T-151M-N	150	20	8.0	1.00	0.60	0.50
SSL0802T-221M-N	220	20	6.0	1.60	0.50	0.40
SSL0802T-331M-N	330	20	5.0	2.20	0.40	0.30
SSL0802T-471M-N	470	20	4.0	3.30	0.30	0.20
SSL0802T-681M-N	680	20	3.0	4.40	0.20	0.10
SSL0802T-102M-N	1000	20	2.5	7.00	0.10	0.05

Note:

\*Inductance Tested at 100 KHz, 0.1 Vrms.

\*\*\* $\Delta T = 30^\circ\text{C}$  Rise Typ at Irms.

\*\*Inductance Drop = 20% Typ. at Isat.

Operating Temperature Range:  $-40^\circ\text{C}$  to  $+85^\circ\text{C}$



### PRODUCT IDENTIFICATION

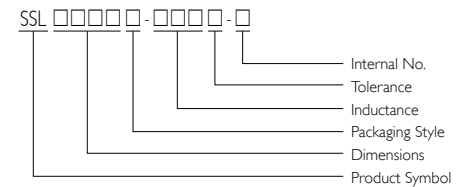

■ Packaging: T = Tape and Reel, B = Bulk

■ Internal No.: N = Lead-Free

### SHAPES AND DIMENSIONS

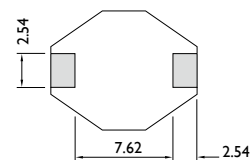
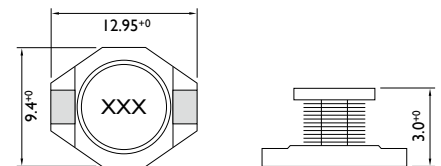

Dimensions: mm

# SMD Power Inductors

# SSL0804 Series



## PRODUCT IDENTIFICATION

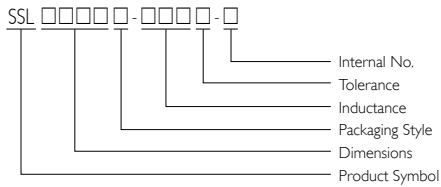

- Packaging: T = Tape and Reel, B = Bulk
- Internal No.: N = Lead-Free

## SHAPES AND DIMENSIONS

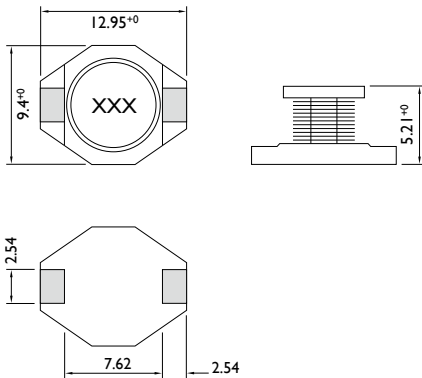

Dimensions: mm

## APPLICATIONS

Notebook Computers, Step-up and Step-down Converters

Flash Memory Programmers, etc.

## FEATURES

High Energy Storage and Very Low Resistance

Smallest Size and High Performance

## ELECTRICAL CHARACTERISTICS

PART NO.	INDUCTANCE * ( $\mu$ H)	TOLERANCE ( $\pm\%$ )	SRF (MHz) Typ.	DC RESISTANCE ( $\Omega$ ) Max.	Isat ** (A)	Irms *** (A)
SSL0804T-1R0M-N	1.0	20	100	0.009	9.0	6.8
SSL0804T-1R5M-N	1.5	20	90	0.010	8.0	6.4
SSL0804T-2R2M-N	2.2	20	80	0.012	7.0	6.1
SSL0804T-3R3M-N	3.3	20	65	0.015	6.4	5.4
SSL0804T-4R7M-N	4.7	20	45	0.018	5.4	4.8
SSL0804T-6R8M-N	6.8	20	38	0.027	4.6	4.4
SSL0804T-100M-N	10	20	30	0.038	3.8	3.9
SSL0804T-150M-N	15	20	27	0.046	3.0	3.1
SSL0804T-220M-N	22	20	19	0.085	2.6	2.7
SSL0804T-330M-N	33	20	15	0.100	2.0	2.1
SSL0804T-470M-N	47	20	12	0.140	1.6	1.8
SSL0804T-680M-N	68	20	10	0.200	1.4	1.5
SSL0804T-101M-N	100	20	9.0	0.280	1.2	1.3
SSL0804T-151M-N	150	20	6.0	0.400	1.0	1.0
SSL0804T-221M-N	220	20	5.0	0.610	0.8	0.8
SSL0804T-331M-N	330	20	4.5	1.020	0.6	0.6
SSL0804T-471M-N	470	20	3.5	1.270	0.5	0.5
SSL0804T-681M-N	680	20	2.5	2.020	0.4	0.4
SSL0804T-102M-N	1000	20	2.0	3.000	0.3	0.3

Note:

\*Inductance Tested at 100 KHz, 0.1 Vrms.

\*\*\* $\Delta$ T = 15 °C Rise Typ at Irms.

\*\*Inductance Drop = 20% Typ. at Isat.

Operating Temperature Range: -40 °C to +85 °C

# SSL0810 Series

## SMD Power Inductors

### APPLICATIONS

Notebook Computers, Step-up and Step-down Converters

Flash Memory Programmers, etc.

### FEATURES

High Energy Storage and Very Low Resistance

Smallest Size and High Performance

### ELECTRICAL CHARACTERISTICS

PART NO.	INDUCTANCE * ( $\mu$ H)	TOLERANCE ( $\pm$ %)	SRF (MHz) Typ.	DC RESISTANCE ( $\Omega$ ) Max.	Isat ** (A)	I <sub>rms</sub> *** (A)
SSL0810T-100M-N	10	20	22	0.033	8.0	3.5
SSL0810T-150M-N	15	20	18	0.042	7.0	3.0
SSL0810T-220M-N	22	20	11	0.054	5.5	2.5
SSL0810T-330M-N	33	20	9.0	0.08	4.0	2.0
SSL0810T-470M-N	47	20	8.0	0.10	3.8	1.6
SSL0810T-680M-N	68	20	7.0	0.17	3.0	1.2
SSL0810T-101M-N	100	20	5.0	0.22	2.5	1.2
SSL0810T-151M-N	150	20	4.0	0.34	2.0	0.9
SSL0810T-221M-N	220	20	3.5	0.44	1.6	0.7
SSL0810T-331M-N	330	20	2.5	0.70	1.2	0.6
SSL0810T-471M-N	470	20	2.0	0.95	1.0	0.3
SSL0810T-681M-N	680	20	2.0	1.20	1.0	0.2
SSL0810T-102M-N	1000	20	1.5	2.00	0.8	0.1

Note:

\*Inductance Tested at 100 KHz, 0.1 Vrms.

\*\*\* $\Delta$ T = 40 °C Rise Typ at I<sub>rms</sub>.

\*\*Inductance Drop = 20% Typ. at Isat.

Operating Temperature Range: -40 °C to +85 °C



### PRODUCT IDENTIFICATION

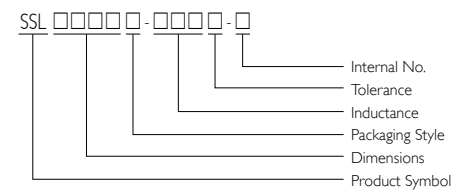

■ Packaging: T = Tape and Reel, B = Bulk

■ Internal No.: N = Lead-Free

### SHAPES AND DIMENSIONS

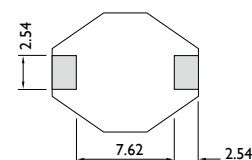
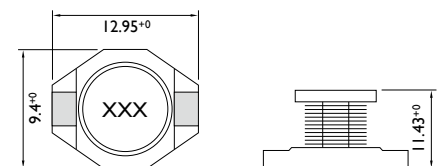

Dimensions: mm

## SMD Power Inductors

# SSL I 306 Series



### PRODUCT IDENTIFICATION

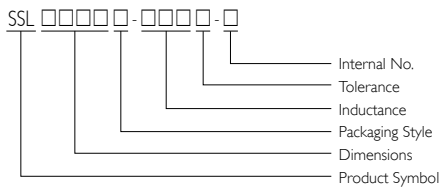

- Packaging: T = Tape and Reel, B = Bulk
- Internal No.: N = Lead-Free

### SHAPES AND DIMENSIONS

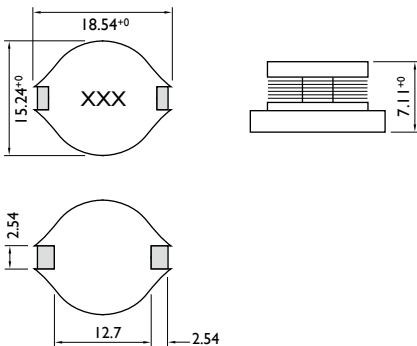

Dimensions: mm

### APPLICATIONS

Notebook Computers, Step-up and Step-down Converters

Flash Memory Programmers, etc.

### FEATURES

High Energy Storage and Very Low Resistance

Smallest Size and High Performance

### ELECTRICAL CHARACTERISTICS

PART NO.	INDUCTANCE * ( $\mu\text{H}$ )	TOLERANCE ( $\pm\%$ )	SRF (MHz) Typ.	DC RESISTANCE ( $\Omega$ ) Max.	Isat ** (A)	Irms *** (A)
SSL I 306T-1R0M-N	1.0	20	80	0.011	20	8.6
SSL I 306T-2R2M-N	2.2	20	80	0.014	16	7.1
SSL I 306T-3R3M-N	3.3	20	60	0.016	14	6.2
SSL I 306T-5R6M-N	5.6	20	40	0.022	12	5.3
SSL I 306T-100M-N	10	20	30	0.032	10	4.3
SSL I 306T-150M-N	15	20	22	0.036	8.0	4.0
SSL I 306T-220M-N	22	20	20	0.047	7.0	3.5
SSL I 306T-330M-N	33	20	15	0.066	5.5	3.0
SSL I 306T-470M-N	47	20	9.0	0.087	4.5	2.6
SSL I 306T-680M-N	68	20	8.0	0.13	3.5	2.3
SSL I 306T-101M-N	100	20	7.0	0.19	3.0	1.8
SSL I 306T-151M-N	150	20	6.0	0.25	2.6	1.5
SSL I 306T-221M-N	220	20	5.0	0.38	2.4	1.2
SSL I 306T-331M-N	330	20	4.0	0.56	1.9	1.0
SSL I 306T-471M-N	470	20	3.0	0.85	1.4	0.82
SSL I 306T-681M-N	680	20	2.5	1.20	1.2	0.72
SSL I 306T-102M-N	1000	20	2.0	1.80	1.0	0.56

Note:

\*Inductance Tested at 100 KHz, 0.1 Vrms.

\*\*\* $\Delta T = 40^\circ\text{C}$  Rise Typ at Irms.

\*\*Inductance Drop = 20% Typ. at Isat.

Operating Temperature Range:  $-40^\circ\text{C}$  to  $+85^\circ\text{C}$



## TAPE DIMENSIONS

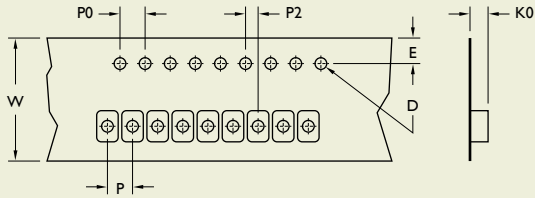

## TAPE MATERIAL

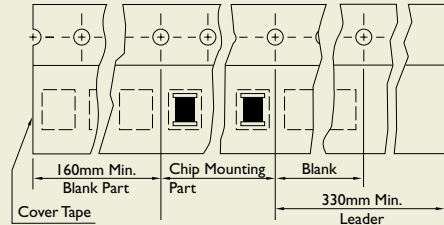

## REEL DIMENSIONS

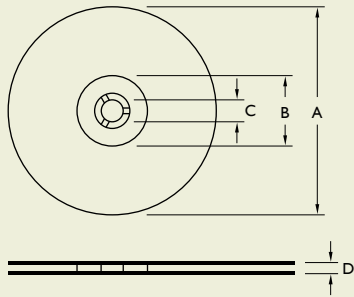

## RECOMMENDED PATTERN

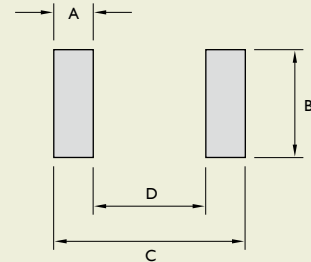

Dimensions: mm

TYPE	TAPE DIMENSIONS							RECOMMENDED PATTERN				REEL DIMENSIONS				QUANTITY/ REEL	
	K0	D	E	W	P	P0	P2	A	B	C	D	A	B	C	D	178	330
SSL04LP	1.30	1.50	1.75	12	8	4	2	1.40	3.56	6.86	4.06	330	100	13	13.4	-	3,500
												178	60		13.2	1,000	-
SSL0400	1.85	1.50	1.75	12	8	4	2	1.40	3.56	6.86	4.06	330	100	13	13.4	-	3,500
												178	60		13.2	1,000	-
SSL0402	3.20	1.55	1.75	12	8	4	2	1.40	3.56	6.86	4.06	330	100	13	13.4	-	2,500
												178	60		13.2	750	-
SSL0614	1.80	1.50	1.75	16	12	4	2	1.21	5.84	9.66	7.24	330	100	13	17.4	-	2,500
SSL0802	3.75	1.55	1.75	24	16	4	2	2.92	2.79	13.21	7.34	330	100	13	24.4	-	1,000
SSL0804	5.40	1.55	1.75	24	16	4	2	2.92	2.79	13.21	7.34	330	100	13	24.4	-	750
SSL0810	11.5	1.55	1.75	24	20	4	2	2.92	2.79	13.21	7.34	330	100	13	24.4	-	225
SSL1306	7.50	1.55	1.75	32	20	4	2	2.92	2.79	18.29	12.45	330	100	13	33.4	-	250

## X-ON Electronics

Largest Supplier of Electrical and Electronic Components

*Click to view similar products for [Multilayer Ceramic Capacitors MLCC - SMD/SMT](#) category:*

*Click to view products by [Yageo](#) manufacturer:*

Other Similar products are found below :

[M39014/01-1467](#) [M39014/02-1218V](#) [M39014/02-1225V](#) [M39014/02-1262V](#) [M39014/02-1301](#) [M39014/22-0631](#) [1210J5000102JCT](#)  
[1210J2K00102KXT](#) [1210J5000103KXT](#) [1210J5000223KXT](#) [D55342E07B379BR-TR](#) [D55342E07B523DR-T/R](#) [1812J1K00103KXT](#)  
[1812J1K00473KXT](#) [1812J2K00680JCT](#) [1812J4K00102MXT](#) [1812J5000102JCT](#) [1812J5000103JCT](#) [1812J5000682JCT](#) [NIN-FB391JTRF](#)  
[NIN-FC2R7JTRF](#) [NPIS27H102MTRF](#) [C1206C101J1GAC](#) [C1608C0G1E472JT000N](#) [C2012C0G2A472J](#) [2220J2K00101JCT](#)  
[KHC201E225M76N0T00](#) [LRC-LRF1206LF-01R025FTR1K](#) [1812J1K00222JCT](#) [1812J2K00102KXT](#) [1812J2K00222KXT](#)  
[1812J2K00472KXT](#) [2-1622820-7-CUT-TAPE](#) [2220J3K00102KXT](#) [2225J2500824KXT](#) [CCR07CG103KM](#) [CGA2B2C0G1H010C](#)  
[CGA2B2C0G1H040C](#) [CGA2B2C0G1H050C](#) [CGA2B2C0G1H060D](#) [CGA2B2C0G1H070D](#) [CGA2B2C0G1H151J](#) [CGA2B2C0G1H1R5C](#)  
[CGA2B2C0G1H2R2C](#) [CGA2B2C0G1H3R3C](#) [CGA2B2C0G1H680J](#) [CGA2B2C0G1H6R8D](#) [CGA2B2X8R1H221K](#) [CGA2B2X8R1H472K](#)  
[CGA3E1X7R1C474K](#)