



Shenzhen Yajingxin Electron Co.,Ltd

Customer	
Production Name	SMD CRYSTAL SEAM 3.2*2.5
Customer P/N	N/A
P/N	T3225374MDBDE2X
Revision	A
Print Date	2024-02-22

Drawn	Checked	Approved
		



RoHS Compliant



Shenzhen Yajingxin Electron Co.,Ltd

● ELECTRICAL PARAMETERS

谐振器产品技术指标	Min	Max	Units
1. Holder Type(型号规格)	SEAM 3.2*2.5		
2. Mode of Oscillation (振动模式)	Fundamental		
3. Frequency (标称频率)	37.400000		MHz
4. Load Capacitance (CL) (负载电容)	10		pF
5. Drive Level (激励功率)	≤100		uw
6. Equivalent Resistance (谐振电阻)	≤30		Ω
7. Shunt Capacitance (Co) (静态电容)	0	3	pF
8. Motional Capacitance (C1) (动态电容)	N/A		fF
9. Frequency Tolerance at 25°C (调整频差)	-10	10	ppm
10. Stability over operation temperance (温度频差)	±30基准温度: 25°C		ppm
11. Insulation Resistance (at DC 100V) (绝缘电阻)	500MΩ Min @100V		MΩ
12. Operating Temperature Range (工作温度范围)	-30	85	°C
13. Storage Temperature Range (储存温度范围)	-40	85	°C
14. Aging (老化率)	±3		ppm/year
15. DLD2	N/A	N/A	Ω
16. FLD2		N/A	ppm
17. RLD2		N/A	Ω
18. SPDB		N/A	db
19. Other(其它)	N/A		

OUTLINE DIMENSIONS(UNIT:mm) 外形尺寸 (单位: mm)

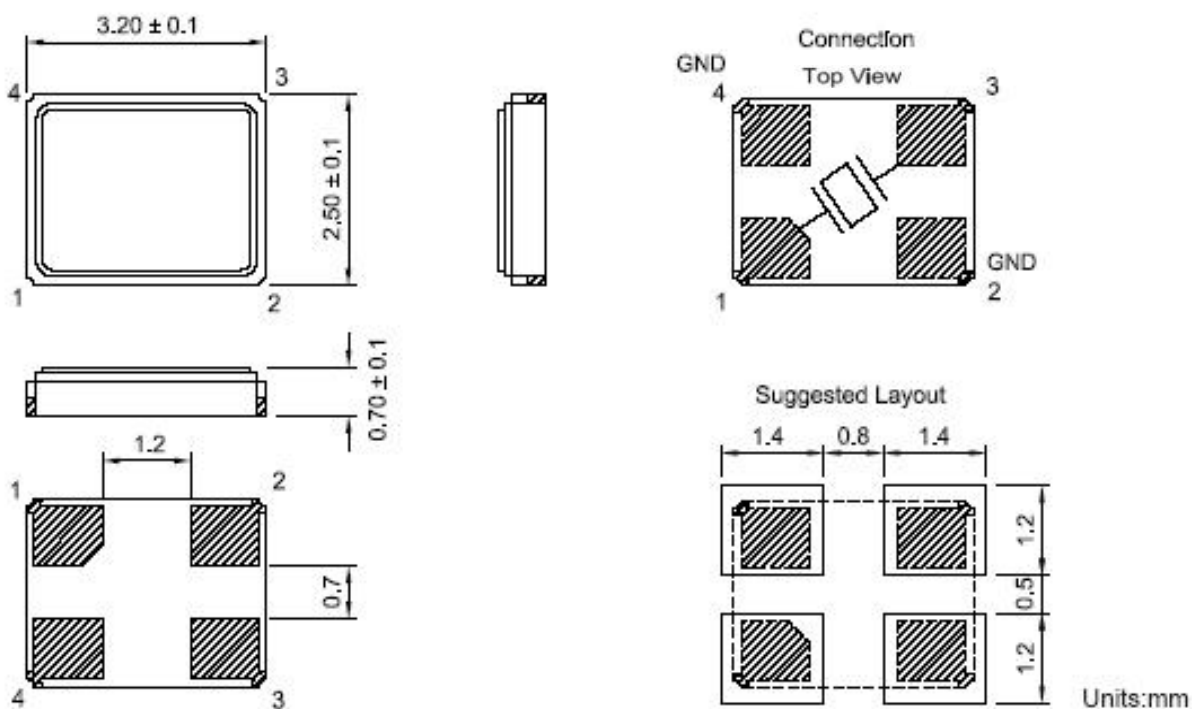



Shenzhen Yajingxin Electron Co.,Ltd

● **SUGGESTED REFLOW PROFILE** (回流焊曲线图)

Total time:200sec.Max. (总时间: 200秒 最大)

Solder melting point:220℃ (熔点 220℃)

Profiles Feature (特性)		Pb-Free Assembly
Average Ramp-up Rate(Ts max to Tp) 平均升温速度		3℃/second Max
Preheat 预热		
■ Temperature Min (Ts min)	最低温度	125℃
■ Temperature Max (Ts max)	最高温度	200℃
■ Time (ts min to ts max)	从最低到最高时间	(60~180) seconds
Time maintained above 维持上述时间		
■ Temperature(T1)	温度	217℃
■ Time(tp)	时间	(60~150) seconds
Peak/Classification Temperature(Tp) 最高点温度		260℃
Time within 5℃ of actual Peak Temperature(tp) 高温维持时间		(20~40) seconds
Ramp-down rate 降温速度		6℃/second max
Time 25℃ to Peak Temperature 从25℃到最高温度的时间		8 minutes max
Suggest reflow times 建议 reflow次数		3 Times max

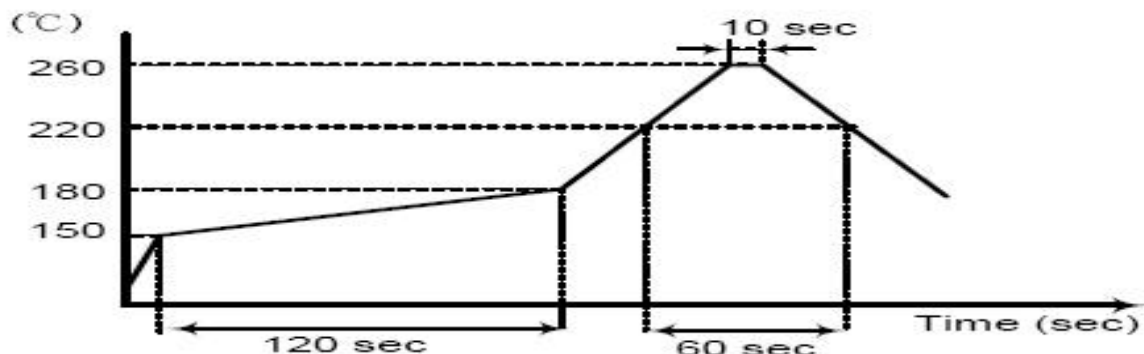

★ 备注:

1. 以上可靠性项目为我司常规测试项目, 若客户对产品有跌落, 冲击, 碰撞以及涉及到超声波焊接工艺的需求, 请将贵司的需求反馈给我司, 我司会对该产品的可靠性项目进行更新。
2. 客户端在对晶体加热后, 为了保证频率的准确性, 建议将晶体充分冷却后再进行相关测试。
3. 产品符合环保标准要求, 如需测试报告请联系我们提供。

● PACKING (包装) 3Kpcs/REEL

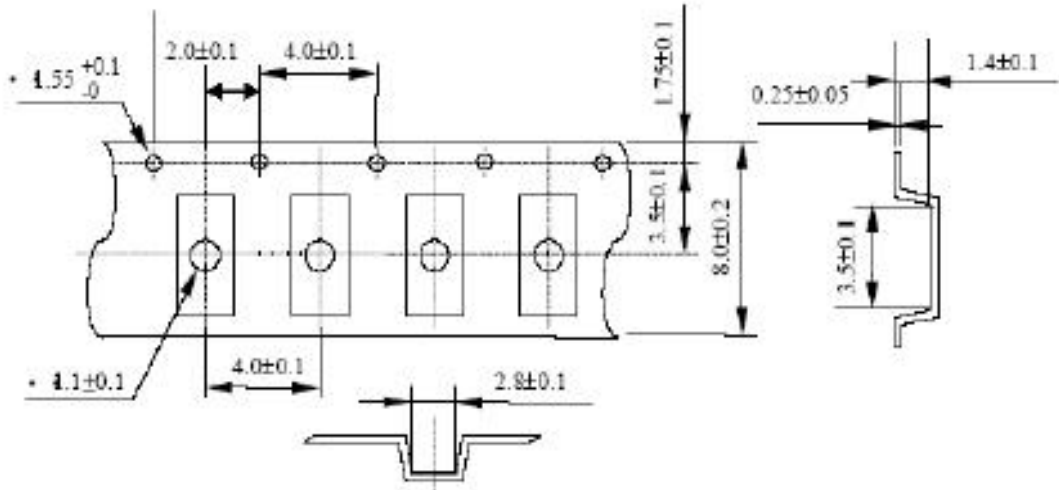

[Size in mm]

8.3. Reel dimension & Outline drawing

Material of the Reel : PS

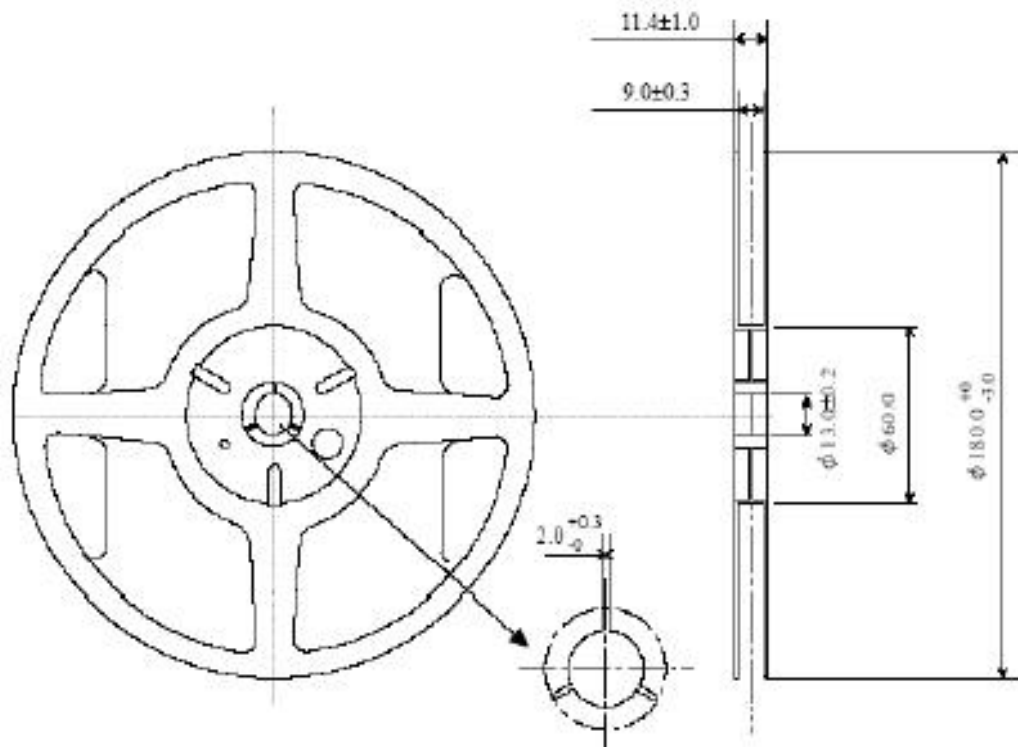

X-ON Electronics

Largest Supplier of Electrical and Electronic Components

Click to view similar products for [Crystals](#) category:

Click to view products by [Yajingxin](#) manufacturer:

Other Similar products are found below :

[CX3225GB25000M0PPSZ1](#) [718-13.2-1](#) [7A-40.000MAAE-T](#) [FL2000085](#) [99-BU](#) [9B-15.360MBBK-B](#) [9C-7.680MBBK-T](#) [H10S-12.000-18-EXT-TR](#) [ABC2-6.000MHZ-D4Z-T](#) [ABLS-20.000MHZ-D2-T](#) [ABS071-32.768KHZ-6-T](#) [R38-32.768-12.5-5PPM-NPB](#) [21U15A-21.4MHZ](#) [RTX-781DF1-S-20.950](#) [LFXTAL066198Cutt](#) [9C-14.31818MBBK-T](#) [A-11.000MHZ-27](#) [ABL-27.000MHZ-B4Y-T](#) [ABM11-132-24.000MHZ-T3](#) [ABM3B1-25.000MHZ-D2Y-T](#) [SPT2A-.032768B](#) [SPT2A.032768G](#) [SSPT7F-9PF20-R](#) [LFXTAL065253Cutt](#) [LFXTAL066431Cutt](#) [XT9S20ANA14M7456](#) [XT9SNLANA16M](#) [7A-24.576MBBK-T](#) [7B-30.000MBBK-T](#) [CX2520DB16000H0HPQCC](#) [MMCC2R32.7680KHZ](#) [6504-202-1501](#) [6526-202-1501](#) [ABLS-12.000MHZ-B2Y-T](#) [7A-10.000MBBK-T](#) [SG636PCE-20.000MC](#) [3404](#) [CM315D32768EZFT](#) [C1E-24.000-7-2020-R](#) [C1E-19.200-12-1530-X-R](#) [C1E-16.000-12-1530-X-R](#) [ABM11-16.000MHZ-9-B1U-T](#) [FL5000014](#) [EUCA18-3.1872M](#) [FX0800015](#) [425F35E027M0000](#) [FP0800018](#) [MS3V-T1R-32.768kHz-7pF-20PPM-TA-QC-Au](#) [VXM7-1C1-16M000](#) [MS3V-T1R-32.768kHz-9pF-20PPM-TA-QC-Au](#)