

● ELECTRICAL PARAMETERS

谐振器产品技术指标	Min	Max	Units
1. Holder Type(型号规格)	SEAM 2.5*2.0		
2. Mode of Oscillation (振动模式)	Fundamental		
3. Frequency (标称频率)	40.000000		MHz
4. Load Capacitance (CL) (负载电容)	10		pF
5. Shunt Capacitance (Co) (静态电容)	0	5	pF
6. Equivalent Resistance (谐振电阻)		40	$\Omega$
7. Frequency Tolerance at 25°C (调整频差)	-10	10	ppm
8. Stability over operation temperature (温度频差)	$\pm 20$		ppm
9. Insulation Resistance (at DC 200~250V) (绝缘电阻)	500		M $\Omega$
10. Drive Level (激励功率)	100		uw
11. Operating Temperature Range (工作温度范围)	-30	85	$^{\circ}\text{C}$
12. Storage Temperature Range (储存温度范围)	-40	85	$^{\circ}\text{C}$
13. Aging (老化率)	$\pm 3$		ppm/year
14. Other(其他)	0		

OUTLINE DIMENSIONS(UNIT:mm) 外形尺寸 (单位: mm)

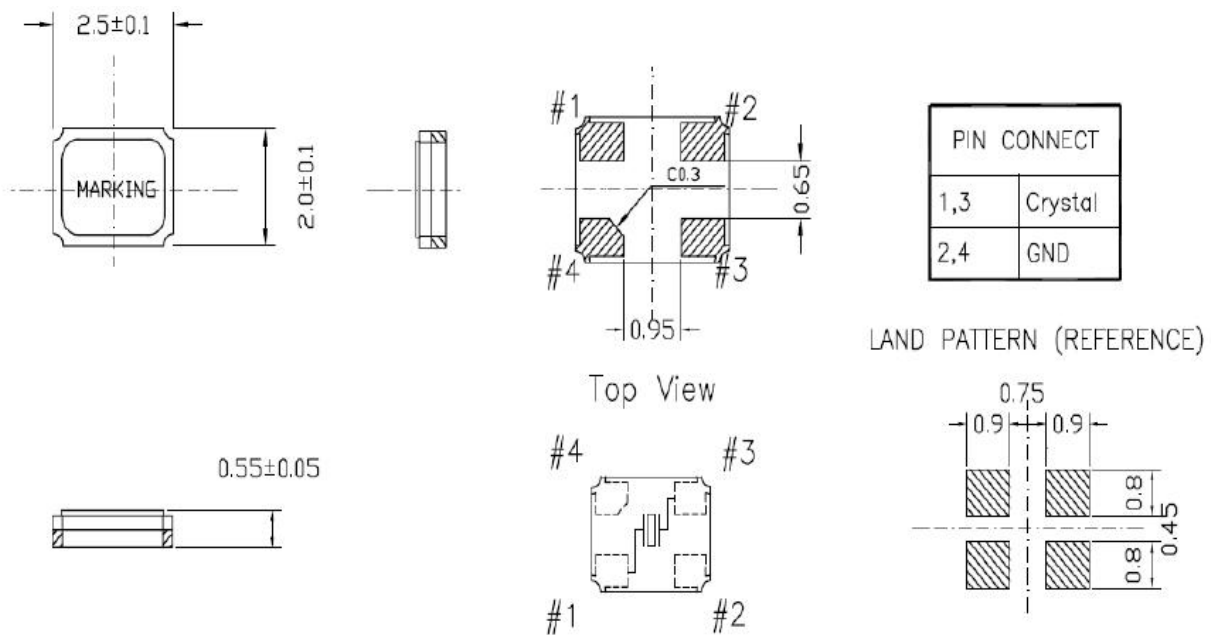

## X-ON Electronics

Largest Supplier of Electrical and Electronic Components

*Click to view similar products for [Crystals](#) category:*

*Click to view products by [Yajingxin](#) manufacturer:*

Other Similar products are found below :

[CX3225GB25000M0PPSZ1](#) [718-13.2-1](#) [7A-40.000MAAE-T](#) [FL2000085](#) [99-BU](#) [9B-15.360MBBK-B](#) [9C-7.680MBBK-T](#) [H10S-12.000-18-EXT-TR](#) [ABC2-6.000MHZ-D4Z-T](#) [ABLS-20.000MHZ-D2-T](#) [ABS071-32.768KHZ-6-T](#) [R38-32.768-12.5-5PPM-NPB](#) [21U15A-21.4MHZ](#) [RTX-781DF1-S-20.950](#) [LFXTAL066198Cutt](#) [9C-14.31818MBBK-T](#) [A-11.000MHZ-27](#) [ABL-27.000MHZ-B4Y-T](#) [ABM11-132-24.000MHZ-T3](#) [ABM3B1-25.000MHZ-D2Y-T](#) [SPT2A-.032768B](#) [SPT2A.032768G](#) [SSPT7F-9PF20-R](#) [LFXTAL065253Cutt](#) [LFXTAL066431Cutt](#) [XT9S20ANA14M7456](#) [XT9SNLANA16M](#) [7A-24.576MBBK-T](#) [7B-30.000MBBK-T](#) [CX2520DB16000H0HPQCC](#) [MMCC2R32.7680KHZ](#) [6504-202-1501](#) [6526-202-1501](#) [ABLS-12.000MHZ-B2Y-T](#) [7A-10.000MBBK-T](#) [SG636PCE-20.000MC](#) [3404](#) [CM315D32768EZFT](#) [C1E-24.000-7-2020-R](#) [C1E-19.200-12-1530-X-R](#) [C1E-16.000-12-1530-X-R](#) [ABM11-16.000MHZ-9-B1U-T](#) [FL5000014](#) [EUCA18-3.1872M](#) [FX0800015](#) [425F35E027M0000](#) [FP0800018](#) [MS3V-T1R-32.768kHz-7pF-20PPM-TA-QC-Au](#) [VXM7-1C1-16M000](#) [MS3V-T1R-32.768kHz-9pF-20PPM-TA-QC-Au](#)