

**QFP** (Open Top)

# IC201 Series

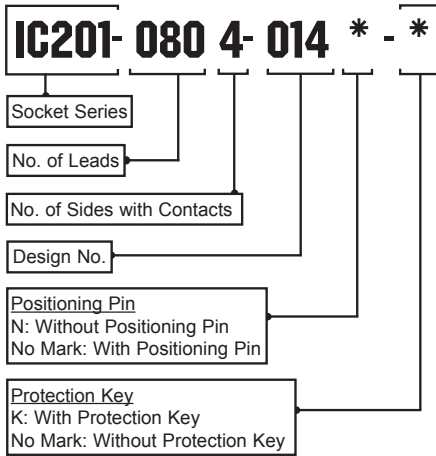
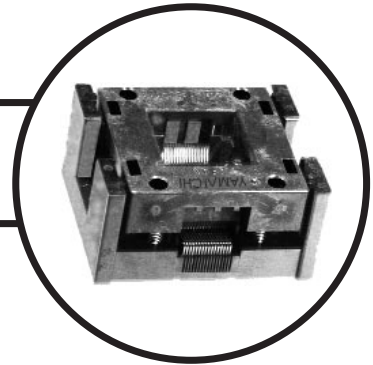

### Characteristics

Insulation Resistance: 1,000M $\Omega$  minimum at 500 VDC  
 Withstanding Voltage: 100-700 VAC for 1 minute  
 Contact Resistance: 30m $\Omega$  max. at 10mA/20mV (Initial)  
 Operating Temperature: -40°C ~ +170°C

### Material

Insulator: PEI (Glass Filled)  
 Contact: Beryllium Copper  
 Plating: Gold over Nickel

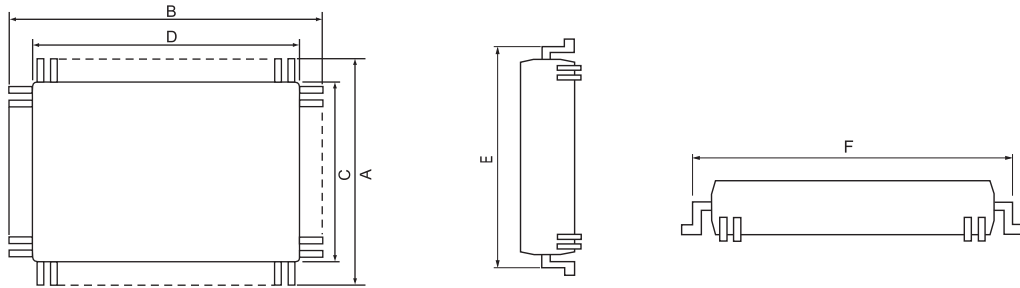

Part Number	No. of Leads	Pitch	Matching Package Dimensions						Notes
			A	B	C	D	E (Max)	F (Max)	
IC201-0644-003	64	0.5mm	12.0	12.0	10.0	10.0	11.3	11.3	W/ protection wall
IC201-0644-019	64	1.0mm	17.9	23.9	14.0	20.0	16.6	22.6	Clamshell IC51-820-KS9376
IC201-0804-020	80	0.5mm	13.6	13.6	12.0	12.0	12.5	12.5	
IC201-0804-012	80	0.65mm	17.2	17.2	14.0	14.0	16.0	16.0	
IC201-0804-014	80	0.5mm	14.0	14.0	12.0	12.0	13.3	13.3	Clamshell IC51-0804-808
IC201-0804-032	80	0.8mm	17.2	23.2	14.0	20.0	16.0	22.0	Clamshell IC51-819-KS12721
IC201-0804-005	80	0.8mm	17.9	23.9	14.0	20.0	16.6	22.6	Clamshell IC51-0804-819-1
IC201-1004-008	100	0.5mm	16.0	16.0	14.0	14.0	15.2	15.2	Clamshell IC51-1004-809
IC201-1004-016	100	0.65mm	17.9	23.9	14.0	20.0	16.6	22.6	Clamshell IC51-1004-814-1
IC201-1004-028	100	0.65mm	17.2	23.2	14.0	20.0	15.8	21.8	Clamshell IC51-814-KS12033
IC201-1204-017	120	0.5mm	18.4	18.4	16.0	16.0	17.1	17.1	
IC201-1444-026-2	144	0.5mm	22.0	22.0	20.0	20.0	21.2	21.2	Clamshell IC51-1444-1354-5
IC201-1444-034	144	0.5mm	22.0	22.0	20.0	20.0	21.2	21.2	Clamshell IC51-1444-1354-7
IC201-1604-006	160	0.65mm	31.2	31.2	28.0	28.0	30.0	30.0	Clamshell IC51-1604-845-4
IC201-1764-033-2	176	0.5mm	26.0	26.0	24.0	24.0	25.2	25.2	
IC201-2084-001	208	0.5mm	30.0	30.0	28.0	28.0	29.1	29.1	
IC201-2084-029	208	0.5mm	30.6	30.6	28.0	28.0	29.8	29.8	
IC201-2564-002	256	0.5mm	30.6	42.6	28.0	40.0	30.1	42.1	
IC201-3044-004	304	0.5mm	42.6	42.6	40.0	40.0	41.6	41.6	Clamshell IC51-3044-1471-2

**Note:** The above represents general guideline information only. We recommend actual check of package before ordering.  
 Please call for other pin-counts.

# PC BOARD LAYOUTS

**QFP** (Open Top)

## IC201 Series

**QFP IC201-0644-003 (64 Pins)**

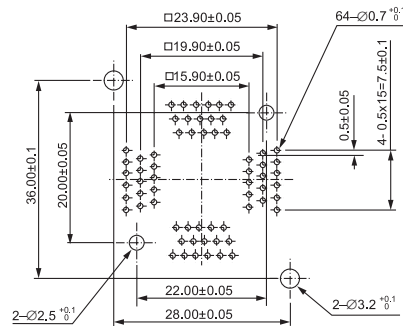

**QFP IC201-0804-005 (80 Pins)**

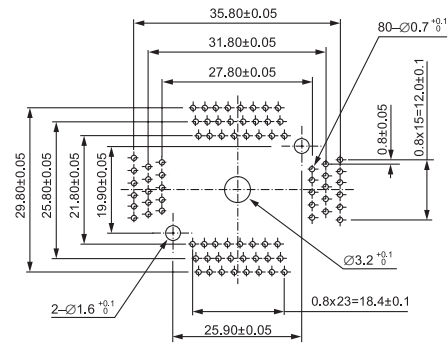

**QFP IC201-0644-019 (64 Pins)**

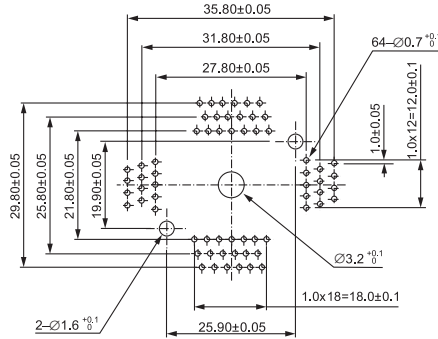

**QFP IC201-0804-012 (80 Pins)**

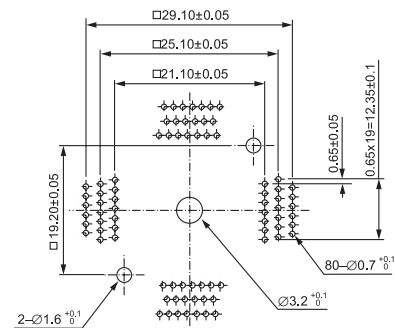

**QFP IC201-0644-040 (64 Pins)**

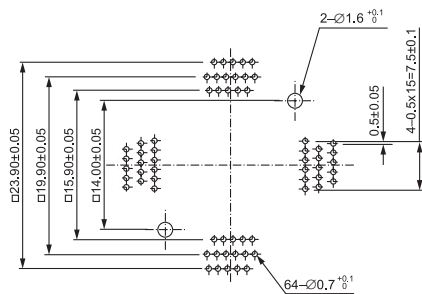

**QFP IC201-0804-014 (80 Pins)**

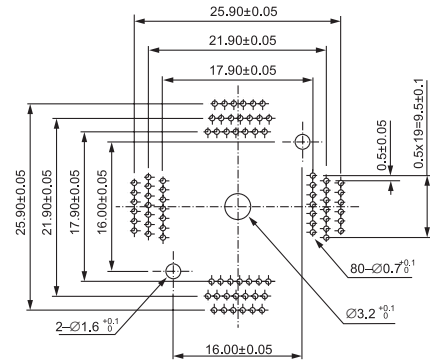

Quad Flat Packages

**IC201 Series**

**QFP IC201-0804-020 (80 Pins)**

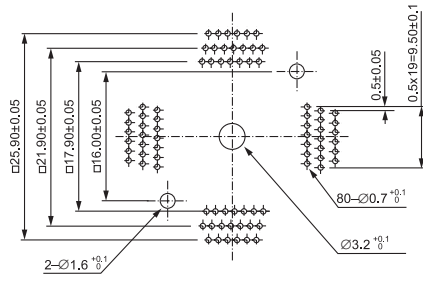

**QFP IC201-1004-016 (100 Pins)**

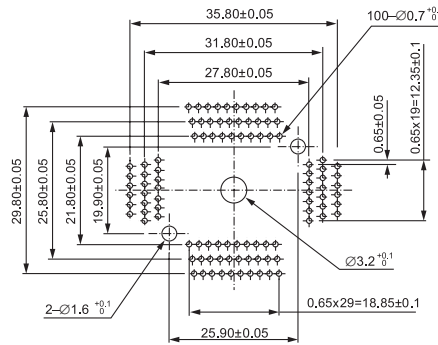

**QFP IC201-0804-032 (80 Pins)**

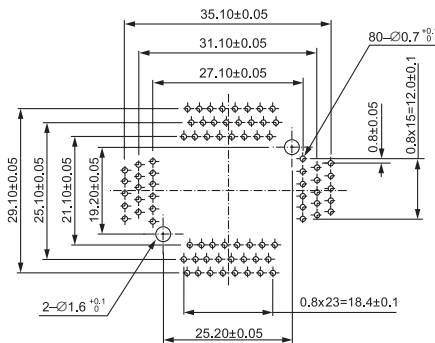

**QFP IC201-1004-028 (100 Pins)**

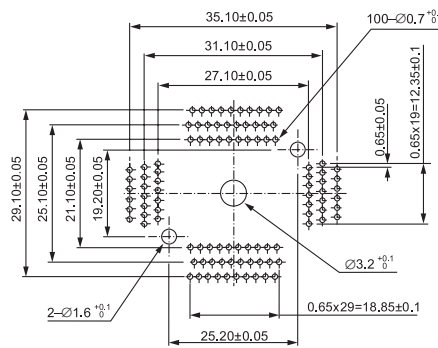

**QFP IC201-1004-008 (100 Pins)**

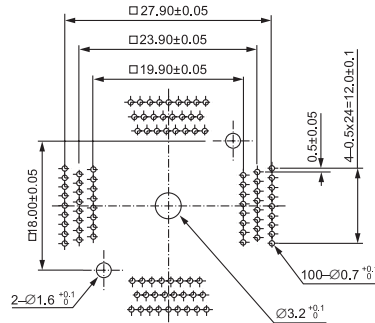

**QFP IC201-1004-050 (100 Pins)**

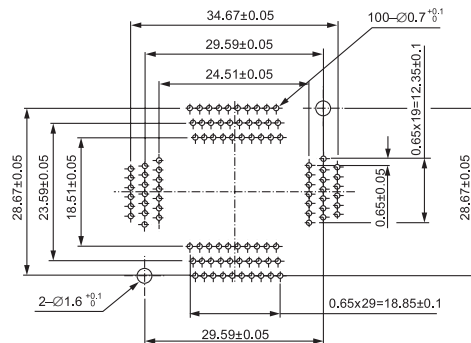

# PC BOARD LAYOUTS

**QFP** (Open Top)

## IC201 Series

**QFP IC201-1204-017 (120 Pins)**

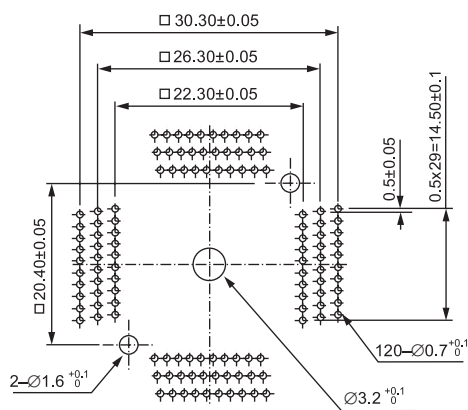

**QFP IC201-1444-034 (144 Pins)**

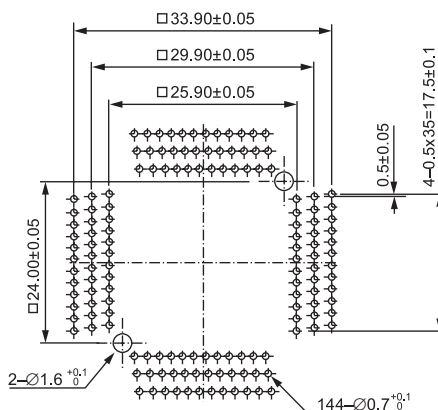

**QFP IC201-1444-026-2 (144 Pins)**

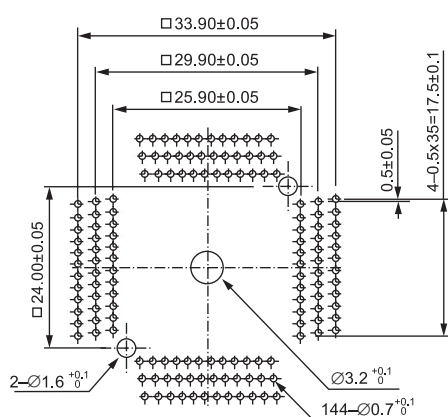

**QFP IC201-1604-006 (160 Pins)**

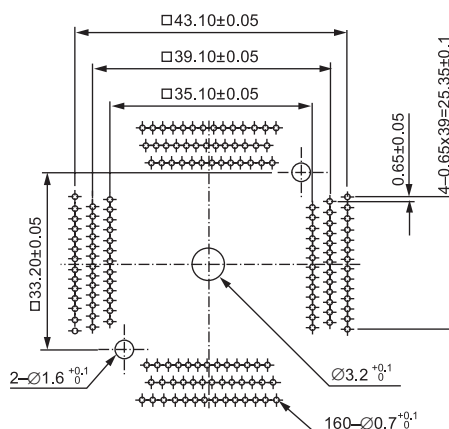

Quad Flat Packages

**QFP** (Open Top)

# IC201 Series

## PC BOARD LAYOUTS

**QFP IC201-2084-001 (208 Pins)**

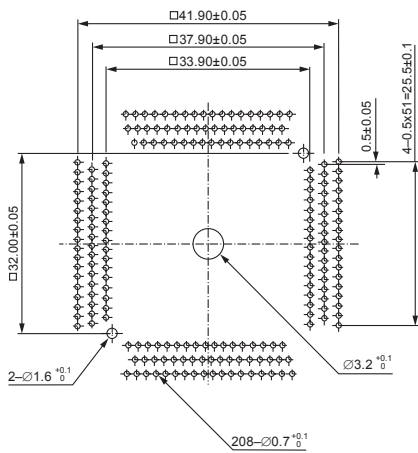

**QFP IC201-2564-002 (256 Pins)**

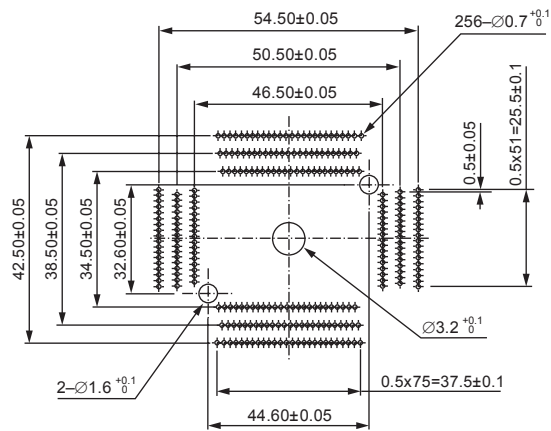

**QFP IC201-2084-029 (208 Pins)**

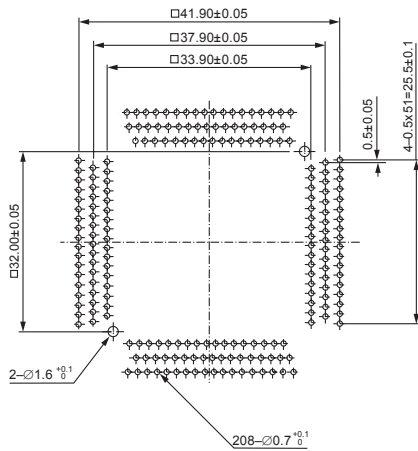

**QFP IC201-3044-004 (304 Pins)**

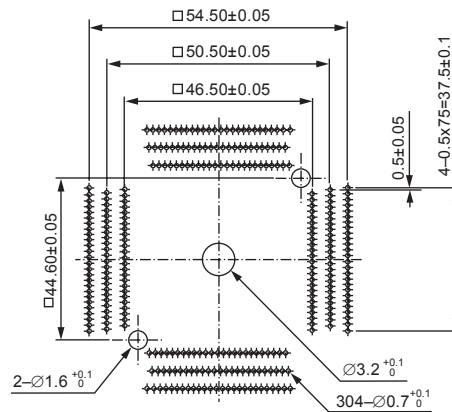

## X-ON Electronics

Largest Supplier of Electrical and Electronic Components

*Click to view similar products for [IC & Component Sockets](#) category:*

*Click to view products by [Yamaichi](#) manufacturer:*

Other Similar products are found below :

[0066-3-17-15-30-14-02-0](#) [670](#) [672](#) [673](#) [694-13-640-00-672-000](#) [712-93-120-41-001000](#) [714-93-104-31-018000](#) [8059-4G1-LF](#) [807-22-001-10-001101](#) [807-22-001-10-006101](#) [807-22-001-30-011101](#) [807-22-001-30-012101](#) [807-22-001-30-013101](#) [807-22-001-30-014101](#) [8-1437531-4](#) [8150-6P10](#) [833-93-034-10-001000](#) [851-41-006-10-001000](#) [851-43-008-20-001000](#) [851-43-014-20-001000](#) [851-93-006-20-001000](#) [851-93-010-20-001000](#) [853-43-020-10-001000](#) [86.010.0053.0](#) [116-43-308-41-007000](#) [PX-68LCC](#) [121-13-318-41-001000](#) [121-13-320-41-001000](#) [121-13-308-41-001000](#) [123-43-314-41-801000](#) [123-43-420-41-001000](#) [122-13-316-41-001000](#) [123-13-624-41-001000](#) [123-43-306-41-001000](#) [12-3513-11](#) [123-91-320-41-001000](#) [126-43-310-41-002000](#) [AKSUN 37V-T](#) [1437503-9](#) [1437504-1](#) [146-44-308-41-013000](#) [146-43-308-41-012000](#) [160-10-308-00-001000](#) [160-40-320-00-001000](#) [214-99-306-01-670800](#) [232-1270-02-0602](#) [2-382761-4](#) [2-5331677-4](#) [2-640360-3](#) [2801-2-00-50-00-00-07-0](#)