

IC51 Series

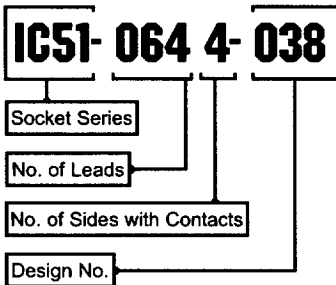
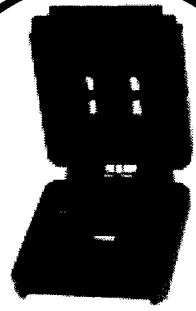

Characteristics

Insulation Resistance:	1,000M Ω minimum at 500 VDC
Withstanding Voltage:	700 VAC for 1 minute
Contact Resistance:	30m Ω max. at 10mA/20mV (Initial)
Operating Temperature:	PES/PEI -55°C ~ +170°C
	PSF -40°C ~ +150°C

Material

Insulator:	PSF / PES / PEI
Contact:	Beryllium Copper
Plating:	Gold over Nickel

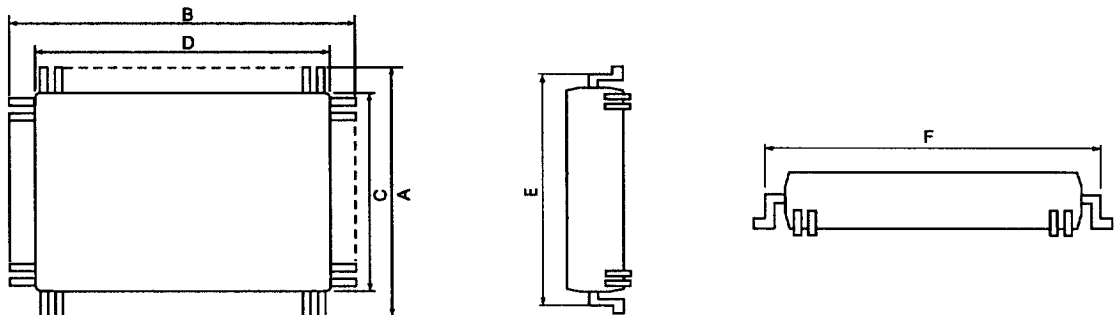

(Reference Only)

Part Number	No. of Leads	Body Size	Pitch	Matching Package Size						Notes
				A	B	C	D	E (Max)	F (Max)	
IC51-0324-805	32	5 x 5	0.5	7.0	7.0	5.0	5.0	6.2	6.2	Floating Base
IC51-0324-354	32	7 x 7	0.8	9.0	9.0	7.0	7.0	8.4	8.4	
IC51-0324-1498	32	7 x 7	0.8	9.0	9.0	7.0	7.0	8.4	8.4	
QFP11T044-001*	44	10 x 10	0.8	12.0	12.0	10.0	10.0	11.3	11.3	
IC51-0444-1195-3	44	10 x 10	0.8	12.6	12.6	10.0	10.0	11.5	11.5	
IC51-0444-825	44	10 x 10	0.8	12.6	12.6	10.0	10.0	11.7	11.7	
IC51-467-KS11247	44	10 x 10	0.8	13.2	13.2	10.0	10.0	12.0	12.0	IC248-0444-001
IC51-0444-798	44	10 x 10	0.8	13.9	13.9	10.0	10.0	12.9	12.9	
IC51-0444-615	44	14 x 14	1.0	17.2	17.2	14.0	14.0	15.8	15.8	
IC51-621-KS8966	44	14 x 14	1.0	17.9	17.9	14.0	14.0	16.5	16.5	
IC51-0484-806	48	7 x 7	0.5	9.0	9.0	7.0	7.0	8.2	8.2	Floating Base
IC51-0484-081	48	12 x 12	0.8	15.3	15.3	12.0	12.0	14.0	14.0	

*Note: New tooling part number.

IC51 Series

(Reference Only)

Part Number	No. of Leads	Body Size	Pitch	Matching Package Size						Notes
				A	B	C	D	E (Max)	F (Max)	
IC51-0484-630	48	12 x 12	0.8	16.9	16.9	12.0	12.0	15.0	15.0	
IC51-0484-831-2	48	14 x 14	1.0	17.2	17.2	14.0	14.0	15.8	15.8	
IC51-0484-831-1	48	14 x 14	1.0	17.9	17.9	14.0	14.0	16.8	16.8	
IC51-0524-1612	52	10 X 10	0.65	12.0	12.0	10.0	10.0	11.2	11.2	Handmade
IC51-0564-680	56	10 X 10	0.65	13.2	13.2	10.0	10.0	11.8	11.8	
IC51-0564-924	56	10 X 14	0.8	13.2	17.2	10.0	14.0	11.8	15.8	
IC51-0564-790	56	16 X 20	1.0	19.2	23.2	16.0	20.0	17.7	21.8	
IC51-0564-1056	56	10 X 10	0.7	13.2	13.2	10.0	10.0	11.8	11.8	
IC51-0604-468	60	14 X 14	0.8	17.2	17.2	14.0	14.0	15.8	15.8	
IC51-0604-104	60	14 X 14	0.8	17.9	17.9	14.0	14.0	16.4	16.4	
IC51-0604-291	60	14 X 14	0.8	17.9	17.9	14.0	14.0	16.7	16.7	w/Separator
IC51-0604-497-2	60	16 X 20	1.0	17.9	23.9	16.0	20.0	17.0	23.0	
IC51-0644-807	64	10 X 10	0.5	12.0	12.0	10.0	10.0	11.3	11.3	FB lidless IC201-0644-003
IC51-0644-1586	64	12 X 12	0.65	15.3	15.3	12.0	12.0	13.9	13.9	Floating Base / Lidless
IC51-1240-AC03026	64	14 X 14	0.8	16.0	16.0	14.0	14.0	15.3	15.3	
IC51-0644-824-3	64	14 X 14	0.8	16.2	16.2	14.0	14.0	15.4	15.4	
IC51-0644-824-1	64	14 X 14	0.8	17.2	17.2	14.0	14.0	15.8	15.8	
IC51-0644-824-2	64	14 X 14	0.8	17.9	17.9	14.0	14.0	16.7	16.7	
IC51-0644-824-5	64	14 X 14	0.8	16.0	16.0	14.0	14.0	15.2	15.2	
IC51-0644-820-2	64	14 X 20	1.0	17.6	23.6	14.0	20.0	16.3	22.3	
IC51-820-2-KS9376	64	14 X 20	1.0	17.9	23.9	14.0	20.0	16.8	22.8	Lidless IC201-0644-019
IC51-0644-820-1	64	14 X 20	1.0	18.7	24.7	14.0	20.0	17.0	23.0	
IC51-0684-734	68	10 X 14	0.65	13.2	17.2	10.0	14.0	11.8	15.8	
IC51-0684-730	68	27 X 27	1.27	30.0	30.0	27.0	27.0	27.5	27.5	Handmade w/ Separator
IC51-0724-119	72	16 X 20	0.8	18.0	23.0	16.0	20.0	16.6	21.5	
IC51-0724-698	73	16 X 20	0.8	18.2	23.1	16.0	20.0	16.5	21.4	
IC51-0804-808	80	12 X 12	0.5	14.0	14.0	12.0	12.0	13.3	13.3	FB IC201-0804-014
IC51-0804-795	80	14 X 14	0.65	16.0	16.0	14.0	14.0	15.3	15.3	
IC51-0804-711	80	14 X 14	0.65	17.2	17.2	14.0	14.0	15.8	15.8	
IC51-0804-956-2	80	14 X 14	0.65	17.2	17.2	14.0	14.0	16.0	16.0	IC149-080-017-S5
IC51-0804-819-6	80	14 X 20	0.8	17.2	23.2	14.0	20.0	15.8	21.8	
IC51-819-KS12720	80	14 X 20	0.8	17.2	23.2	14.0	20.0	16.3	22.3	IC201-0804-032
IC51-0804-819-2	80	14 X 20	0.8	17.6	23.6	14.0	20.0	16.3	22.3	
IC51-0804-819-1	80	14 X 20	0.8	17.9	23.9	14.0	20.0	16.8	22.8	Lidless IC201-0804-005
IC51-0884-999	88	20 X 20	0.8	23.0	23.0	20.0	20.0	22.3	22.3	
IC51-0884-1290	88	12 X 12	0.5	14.0	14.0	12.0	12.0	13.3	13.3	FB
IC51-1004-809	100	14 X 14	0.5	16.0	16.0	14.0	14.0	15.2	15.2	Lidless IC201-1004-008
IC51-1004-814-6	100	14 X 20	0.7	17.2	23.2	14.0	20.0	15.8	21.8	
IC51-1004-814-13	100	14 X 20	0.65	16.0	22.0	14.0	20.0	15.2	21.2	
IC51-814-KS12033	100	14 X 20	0.65	17.2	23.2	14.0	20.0	16.4	22.4	Lidless IC201-1004-028

IC51 Series

(Reference Only)

Part Number	No. of Leads	Body Size	Pitch	Matching Package Size						Notes
				A	B	C	D	E (Max)	F (Max)	
IC51-1004-814-2	100	14 x 20	0.65	17.6	23.6	14.0	20.0	16.4	22.4	
IC51-1004-814-1	100	14 x 20	0.65	17.9	23.9	14.0	20.0	17.0	23.0	FB/Lidless IC201-1004-016
IC51-1004-567	100	22 x 22	0.8	27.8	27.8	22.0	22.0	25.8	25.8	Dead Bug Loading
IC51-1124-1036-2	112	20 x 20	0.65	23.3	23.3	20.0	20.0	22.3	22.3	
IC51-1204-1812	120	14 x 14	0.4	16.0	16.0	14.0	14.0	15.2	15.2	Floating Base
IC51-1204-1497	120	28 x 28	0.8	31.2	31.2	28.0	28.0	30.0	30.0	
IC51-1204-1646	120	28 x 28	0.8	32.0	32.0	28.0	28.0	30.8	30.8	
IC51-1204-1652	120	16 x 16	0.5	18.4	18.4	16.0	16.0	17.5	17.5	FB/IC201-1204-017
IC51-1497-KS11444	120	28 x 28	0.8	31.9	31.9	28.0	28.0	30.5	30.5	
IC51-1284-844-3	128	28 x 28	0.8	31.9	31.9	28.0	28.0	30.6	30.6	w/Separator
IC51-1284-1433	128	14 x 20	0.5	16.0	22.0	14.0	20.0	15.0	21.0	Floating Base / TQFP
IC51-1284-1433-10	128	14 x 20	0.5	17.2	23.2	14.0	20.0	16.4	22.4	Floating Base
IC51-1284-1788	128	14 x 14	0.4	16.0	16.0	14.0	14.0	15.3	15.3	Floating Base
IC51-1284-976-2	128	28 x 28	0.80	31.2	31.2	28.0	28.0	30.0	30.0	
IC51-1284-976-1	128	28 x 28	0.80	31.9	31.9	28.0	28.0	30.5	30.5	Lidless IC200-1284-001
IC51-1444-1354	144	20 x 20	0.5	22.0	22.0	20.0	20.0	21.2	21.2	Floating Base
IC51-1444-1354-7	144	20 x 20	0.5	22.0	22.0	20.0	20.0	21.3	21.3	Floating Base / TQFP
IC51-1354-KS11590	144	20 x 20	0.5	23.2	23.2	22.0	22.0	22.3	22.3	Floating Base
IC51-1444-1014-3	144	28 x 28	0.65	31.2	31.2	28.0	28.0	30.4	30.4	
IC51-1014-KS11225	144	28 x 28	0.65	31.6	31.6	28.0	28.0	30.6	30.6	
IC51-1014-KS12626	144	28 x 28	0.65	32.0	32.0	28.0	28.0	31.0	31.0	
IC51-1505-AC07095	160	24 x 24	0.50	26.0	26.0	24.0	24.0	25.3	25.3	SFB / TQFB
IC51-1604-1350	160	24 x 24	0.50	26.0	26.0	24.0	24.0	25.2	25.2	Floating Base
IC51-1604-1350-2	160	24 x 24	0.5	26.0	26.0	24.0	24.0	25.3	25.3	Floating Base / TQFP
IC51-1604-845-4	160	28 x 28	0.65	31.2	31.2	28.0	28.0	30.0	30.0	Lidless IC201-1604-006
IC51-1604-845-1	160	28 x 28	0.65	31.9	31.9	28.0	28.0	30.5	30.5	
IC51-1764-1995-6	176	20 x 20	0.4	22.0	22.0	20.0	20.0	21.2	21.2	Floating Base / TQFP
IC51-1764-1505	176	24 x 24	0.5	26.0	26.0	24.0	24.0	25.3	25.3	Floating Base
IC51-1764-1505-5	176	24 x 24	0.5	26.0	26.0	24.0	24.0	25.3	25.3	Floating Base / TQFP
IC51-1844-1148-1	184	32 x 32	0.65	35.2	35.2	32.0	32.0	33.7	33.7	Floating Base
IC51-1844-1541	184	32 x 32	0.65	35.75	35.75	32.0	32.0	34.0	34.0	Floating Base
IC51-1964-1952	196	32.29x32.29	0.64	—	—	32.3	32.3	56.5	56.5	NCTB
IC51-2084-1052-* †	208	28 x 28	0.5	—	—	28.0	28.0	—	—	Floating Base
IC51-2084-1509	208	28 x 28	0.5	30.6	30.6	28.0	28.0	29.9	29.9	MQAD®
IC51-2404-1655-2	240	32 x 32	0.5	34.6	34.6	32.0	32.0	33.8	33.8	Floating Base
IC51-2404-1655-3	240	32 x 32	0.5	34.6	34.6	31.6	31.6	33.7	33.7	Floating Base / TQFP
IC51-2404-1655-4	240	32 x 32	0.5	34.0	34.0	32.0	32.0	33.4	33.4	Floating Base / TQFP
IC51-2564-1668	256	28 x 28	0.4	30.6	30.6	28.0	28.0	29.9	29.9	Floating Base
IC51-2564-1668-9	256	28 x 28	0.4	30.6	30.6	28.0	28.0	29.4	29.4	Floating Base
IC51-2564-1668-10	256	28 x 28	0.4	30.0	30.0	28.0	28.0	29.4	29.4	Floating Base / TQFP
IC51-2564-1668-15	256	28 x 28	0.4	30.0	30.0	28.0	28.0	29.2	29.2	Floating Base / TQFP
QFP12T256-001	256	42 x 42	0.5	46.4	46.4	42.0	42.0	45.0	45.0	MQAD®
IC51-2724-1727	272	36 x 36	0.5	39.9	39.9	36.0	36.0	37.6	37.6	Floating Base
IC51-3044-1471-2	304	40 x 40	0.5	42.6	42.6	40.0	40.0	41.6	41.6	Lidless IC201-3044-004
IC51-3044-1471-5	304	40 x 40	0.5	42.6	42.6	39.64	39.64	41.9	41.9	MQAD®

FB = Floating Base

† = We have many variations of this product. Please contact our salespersons for further details.

This information is for reference only. We recommend actual check of package for any socket with a Floating Base before ordering.

MQAD® is a Registered Trademark of Olin Corp.

For detailed drawings or information please contact our sales office at (408) 456-0797.

PC BOARD LAYOUTS

IC51 Series

IC51-0324-805 (32 Pins)

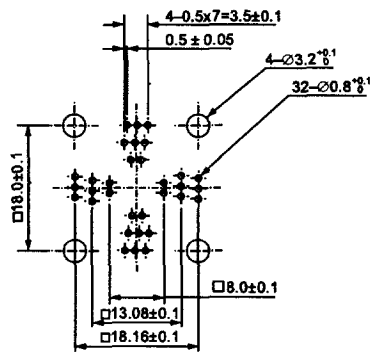

IC51-0444-1195-3 (44 Pins)

IC51-0444-825 (44 Pins)

IC51-467-KS11247 (44 Pins)

IC51-467-KS11787 (44 Pins)

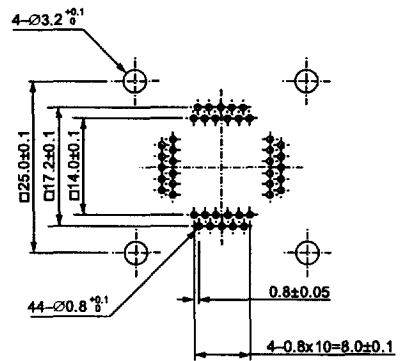

IC51-0324-1498 (32 Pins)

IC51-0324-354 (32 Pins)

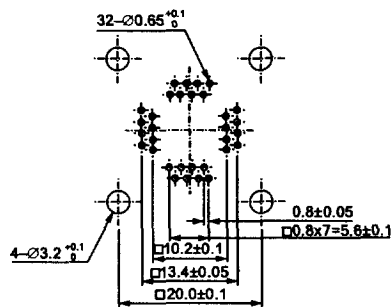

IC51 Series

PC BOARD LAYOUTS

IC51-0444-798 (44 Pins)

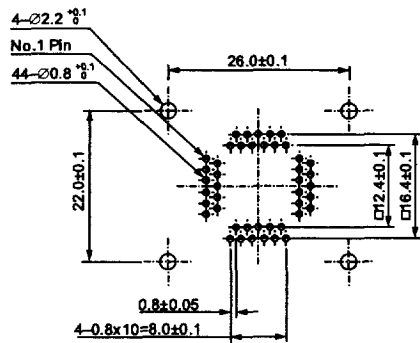

IC51-0484-806 (48 Pins)

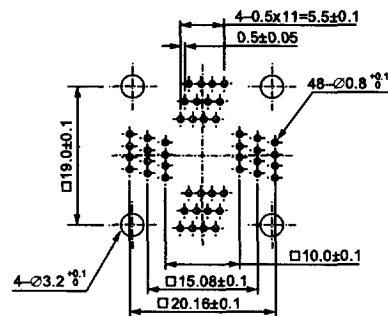

IC51-0444-615 (44 Pins)

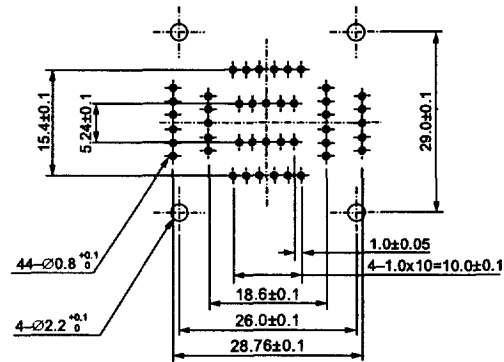

PC BOARD LAYOUTS

IC51 Series

IC51-0484-081 (48 Pins)

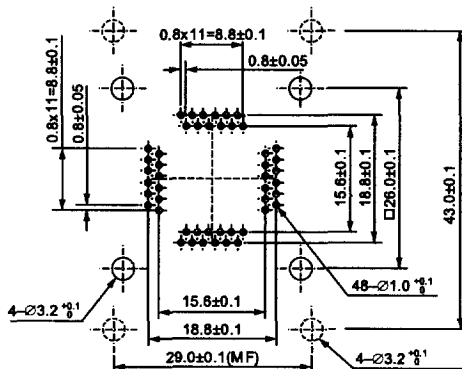

IC51-0564-924 (56 Pins)

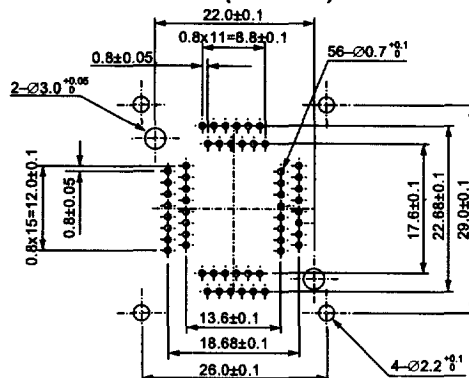

IC51-0564-680 (56 Pins)

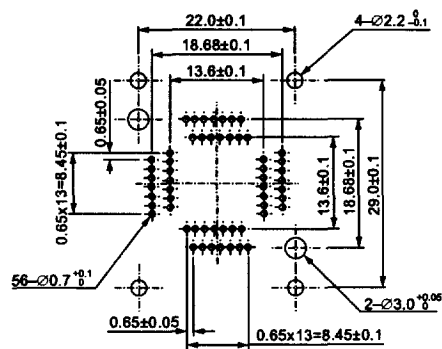

IC51-0564-790 (56 Pins)

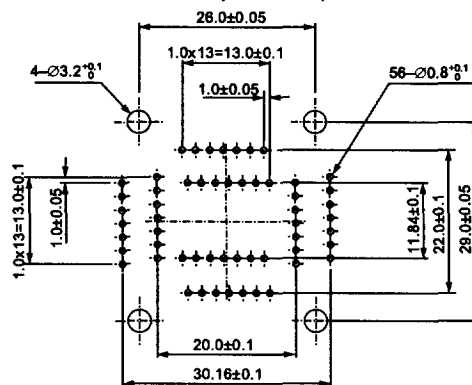

IC51 Series

PC BOARD LAYOUTS

IC51-1004-809 (100 Pins)

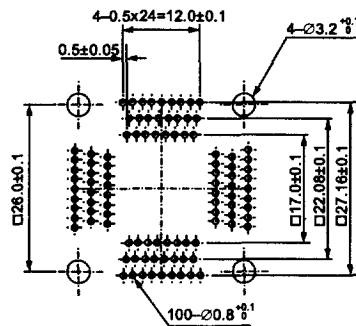

IC51-1004-567 (100 Pins)

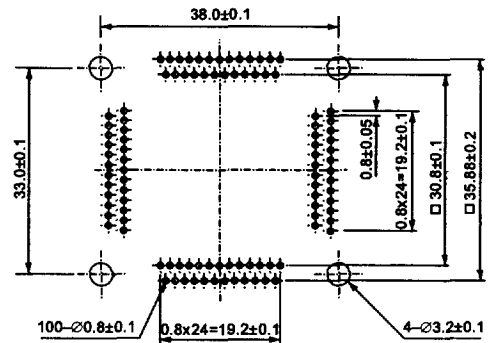

IC51-1124-1036-2 (112 Pins)

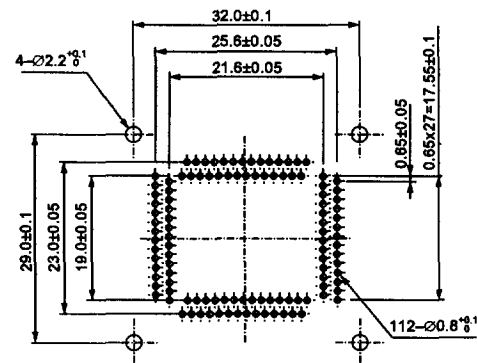

IC51-1004-814-1 (100 Pins)

IC51-1004-814-2 (100 Pins)

IC51-1004-814-13 (100 Pins)

IC51-814-KS12033 (100 Pins)

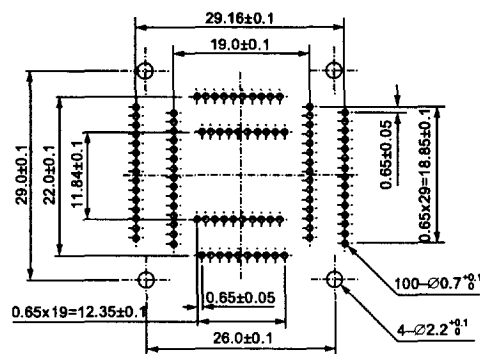

IC51-1204-1812 (120 Pins)

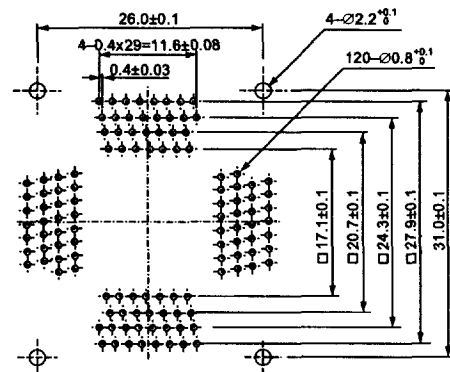

PC BOARD LAYOUTS

IC51 Series

- IC51-0644-692 (64 Pins)
- IC51-0644-824-1 (64 Pins)
- IC51-0644-824-2 (64 Pins)
- IC51-0644-824-3 (64 Pins)

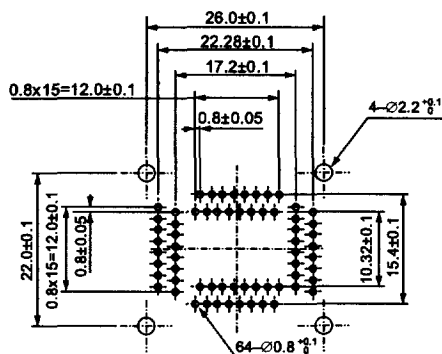

IC51-0684-734 (68 Pins)

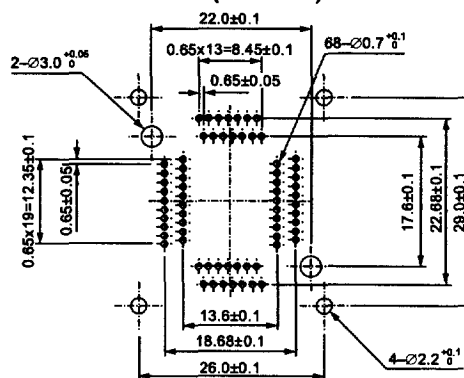

- IC51-0644-472 (64 Pins)
- IC51-0644-820-1 (64 Pins)
- IC51-0644-820-2 (64 Pins)
- IC51-0644-820-4 (64 Pins)
- IC51-820-2-KS9376 (64 Pins)

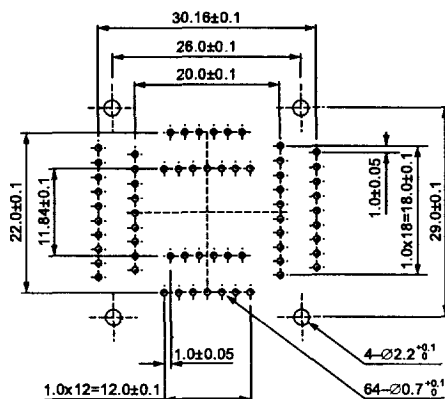

IC51-0724-698 (72 Pins)

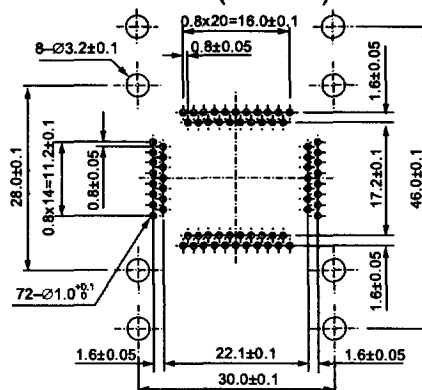

IC51 Series

PC BOARD LAYOUTS

IC51-0804-808 (80 Pins)

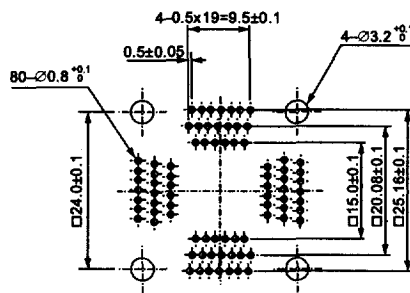

IC51-0804-795 (80 Pins)

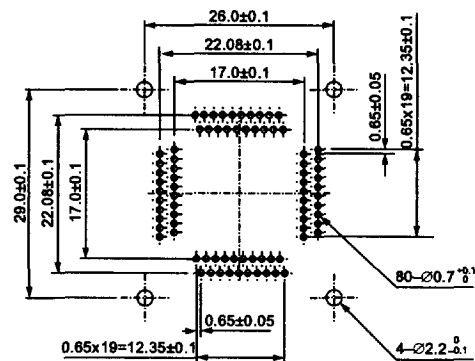

IC51-0804-711 (80 Pins)

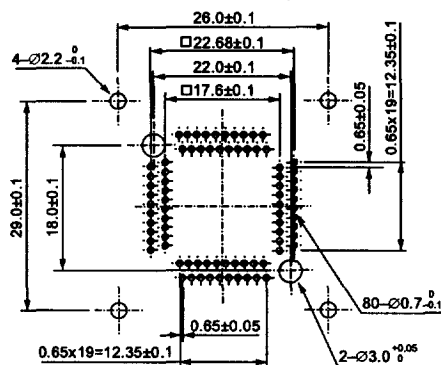

IC51-0804-819-1 (80 Pins)

IC51-0804-819-2 (80 Pins)

IC51-0804-819-8 (80 Pins)

IC51-819-KS12720 (80 Pins)

IC51-0804-956-2 (80 Pins)

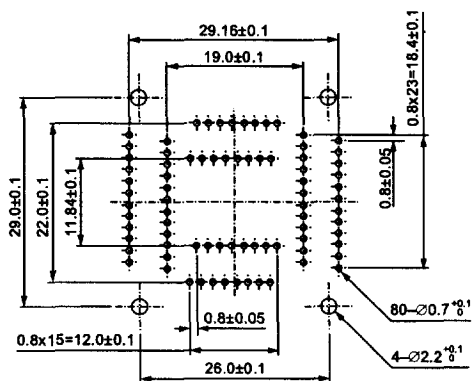
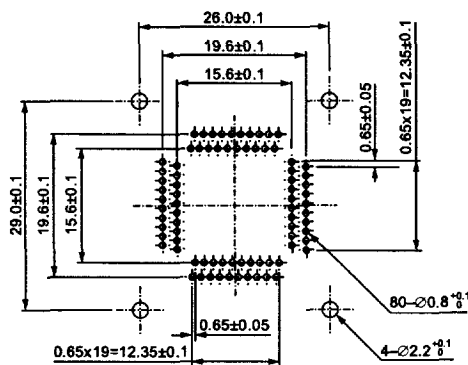

***PC BOARD
LAYOUTS***

IC51 Series

IC51 Series

PC BOARD LAYOUTS

IC51-1204-1652 (120 Pins)

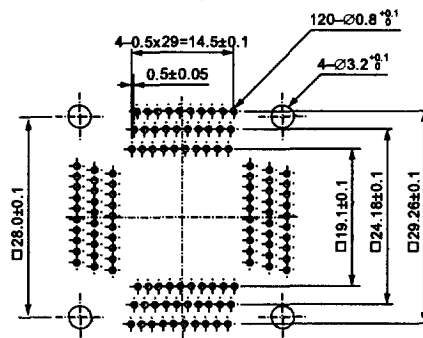

IC51-1284-1433 (128 Pins)
IC51-1284-1433-10 (128 Pins)

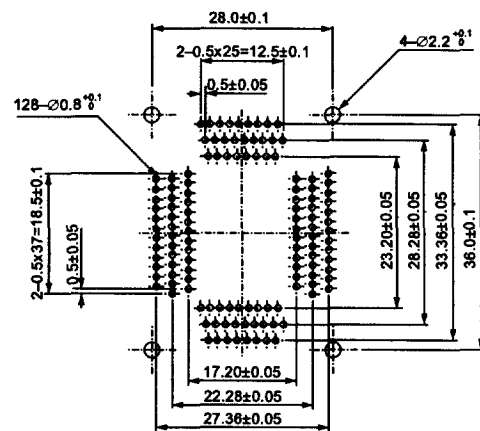

IC51-1497-KS11444 (120 Pins)
IC51-1204-1497 (120 Pins)

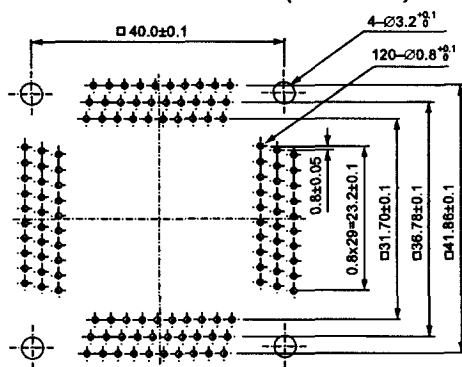

IC51-1284-844-1 (128 Pins)
IC51-1284-976-1 (128 Pins)
IC51-1284-976-2 (128 Pins)
IC51-844-KS13329 (128 Pins)

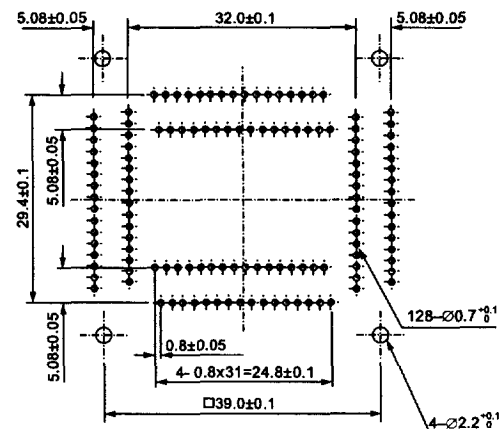

PC BOARD LAYOUTS

IC51 Series

IC51-1444-1354 (144 Pins)

IC51-1444-1354-7 (144 Pins)

IC51-1354-KS11590 (144 Pins)

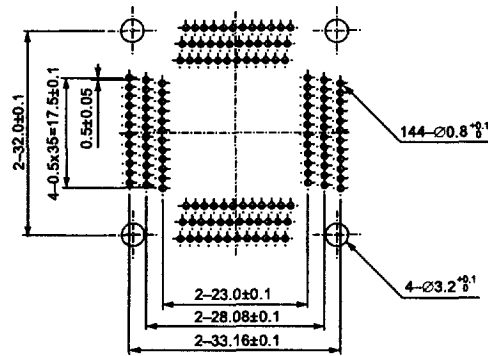

IC51-1604-1350 (160 Pins)

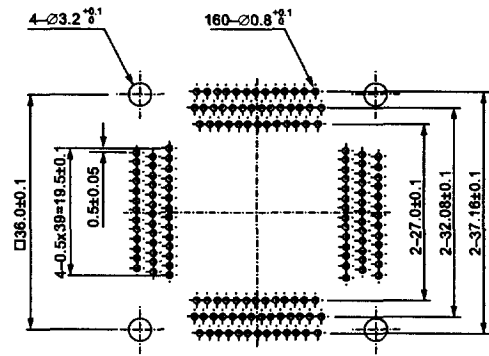

IC51-1444-1014 (144 Pins)

IC51-1444-1014-3 (144 Pins)

IC51-1014-KS11137 (144 Pins)

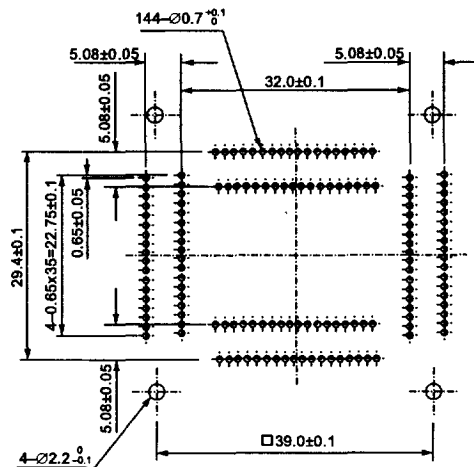

IC51-1604-845-1 (160 Pins)

IC51-1604-845-4 (160 Pins)

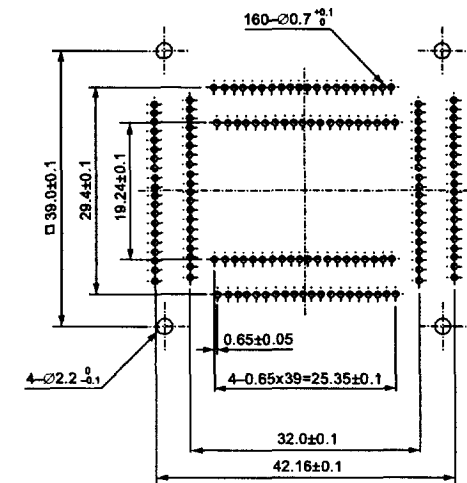

IC51 Series

PC BOARD LAYOUTS

IC51-1764-1505 (176 Pins)

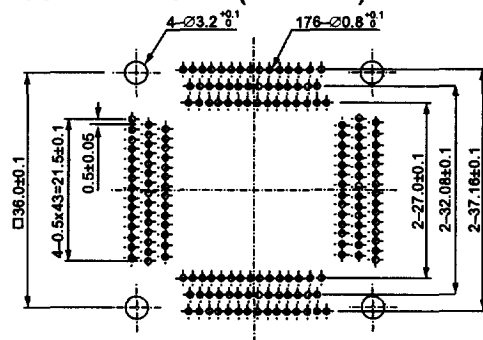

IC51-2084-1052-* 1) (208 Pins)
IC51-2084-1509 (208 Pins)

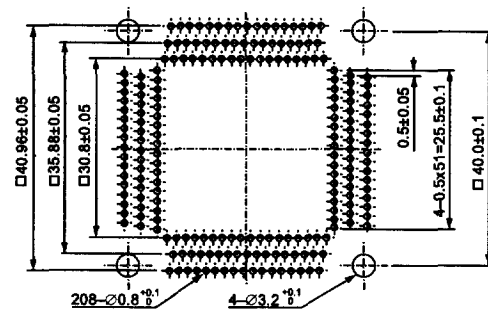

*1) for type: -1, -2, -3, -5, -6, -7, -9 and -11

IC51-1844-1148-1 (184 Pins)

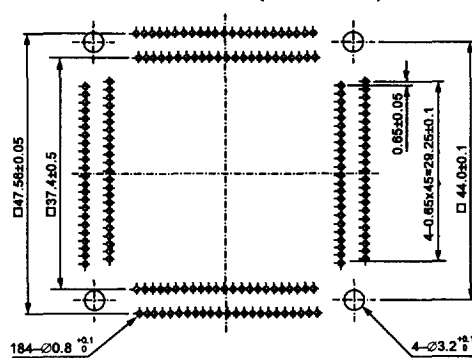

IC51-2084-1052-* 2) (208 Pins)

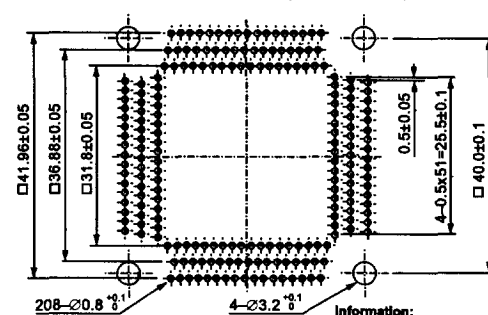

*2) for type: -4, -8 and -13

Information:
We have many variations
of this product.
Please contact our sales
staff for further details.

IC51-1844-1541 (184 Pins)

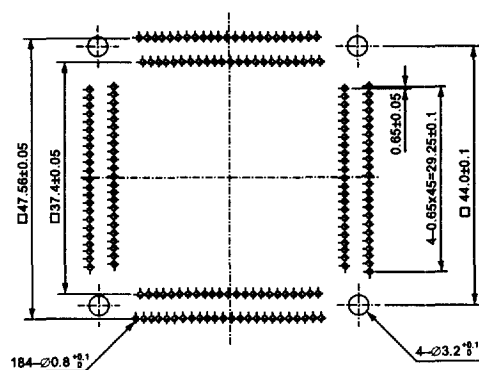

IC51-2404-1655-2 (240 Pins)
IC51-2404-1655-3 (240 Pins)

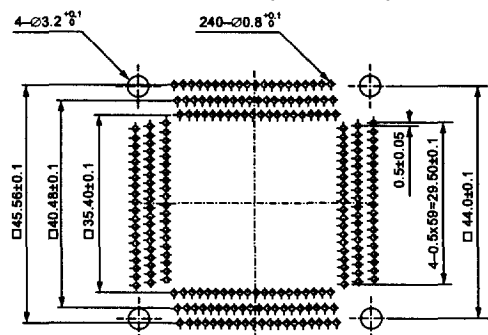

PC BOARD LAYOUTS

IC51 Series

IC51-2564-1668 (256 Pins)

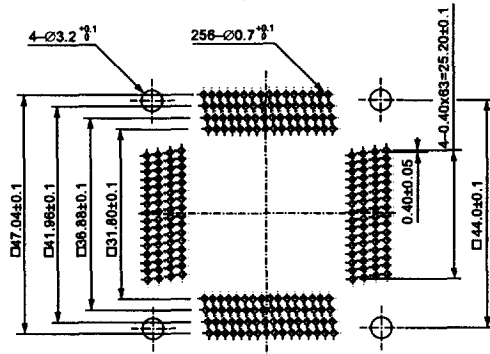

IC51-2724-1727 (272 Pins)

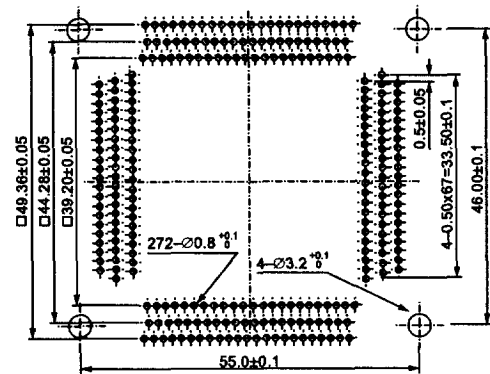

IC51-3044-1471-2 (304 Pins)

IC51-3044-1471-5 (304 Pins)

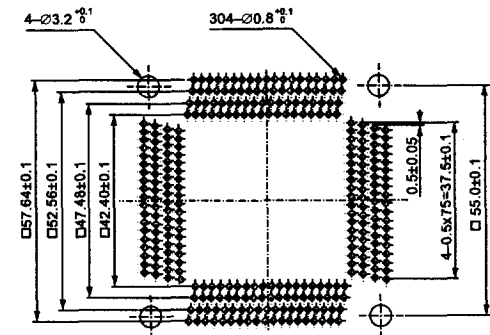

X-ON Electronics

Largest Supplier of Electrical and Electronic Components

Click to view similar products for [IC & Component Sockets](#) category:

Click to view products by [Yamaichi](#) manufacturer:

Other Similar products are found below :

[0066-3-17-15-30-14-02-0](#) [670](#) [672](#) [673](#) [694-13-640-00-672-000](#) [712-93-120-41-001000](#) [714-93-104-31-018000](#) [8059-4G1-LF](#) [807-22-001-10-001101](#) [807-22-001-10-006101](#) [807-22-001-30-011101](#) [807-22-001-30-012101](#) [807-22-001-30-013101](#) [807-22-001-30-014101](#) [8-1437531-4](#) [8150-6P10](#) [833-93-034-10-001000](#) [851-41-006-10-001000](#) [851-43-008-20-001000](#) [851-43-014-20-001000](#) [851-93-006-20-001000](#) [851-93-010-20-001000](#) [853-43-020-10-001000](#) [86.010.0053.0](#) [116-43-308-41-007000](#) [PX-68LCC](#) [121-13-318-41-001000](#) [121-13-320-41-001000](#) [121-13-308-41-001000](#) [123-43-314-41-801000](#) [123-43-420-41-001000](#) [122-13-316-41-001000](#) [123-13-624-41-001000](#) [123-43-306-41-001000](#) [12-3513-11](#) [123-91-320-41-001000](#) [126-43-310-41-002000](#) [AKSUN 37V-T](#) [1437503-9](#) [1437504-1](#) [146-44-308-41-013000](#) [146-43-308-41-012000](#) [160-10-308-00-001000](#) [160-40-320-00-001000](#) [214-99-306-01-670800](#) [232-1270-02-0602](#) [2-382761-4](#) [2-5331677-4](#) [2-640360-3](#) [2801-2-00-50-00-00-07-0](#)