

## N-Channel Enhancement Mode Field Effect Transistor

### Product Summary

- $V_{DS}$  60V
- $I_D$  340mA
- $R_{DS(ON)}$ ( at  $V_{GS}=10V$ ) <2.5ohm
- $R_{DS(ON)}$ ( at  $V_{GS}=4.5V$ ) <3.0ohm

### General Description

- Trench Power MV MOSFET technology
- Voltage controlled small signal switch
- Low input Capacitance
- Fast Switching Speed
- Low Input / Output Leakage

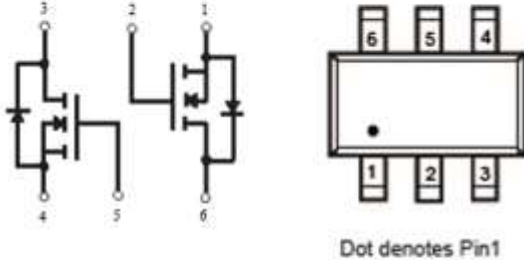

SOT-363

### Applications

- Battery operated systems
- Solid-state relays
- Direct logic-level interface: TTL/CMOS

### ■ Absolute Maximum Ratings ( $T_A=25^\circ C$ unless otherwise noted)

Parameter	Symbol	Limit	Unit
Drain-source Voltage	$V_{DS}$	60	V
Gate-source Voltage	$V_{GS}$	$\pm 30$	V
Peak Gate-source Voltage $T_p < 50\mu s$ , duty cycle=0.25	$V_{GSm}$	$\pm 40$	V
Drain Current	$I_D$	$T_A=25^\circ C$ @ Steady State	340
		$T_A=70^\circ C$ @ Steady State	272
Pulsed Drain Current <sup>A</sup>	$I_{DM}$	1.5	A
Total Power Dissipation @ $T_A=25^\circ C$	$P_D$	350	mW
Thermal Resistance Junction-to-Ambient @ Steady State <sup>B</sup>	$R_{\theta JA}$	357	$^\circ C/W$
Junction and Storage Temperature Range	$T_J, T_{STG}$	-55~+150	$^\circ C$

### ■ Ordering Information (Example)

PREFERRED P/N	PACKING CODE	Marking	MINIMUM PACKAGE(pcs)	INNER BOX QUANTITY(pcs)	OUTER CARTON QUANTITY(pcs)	DELIVERY MODE
2N7002DW	F2	K72	3000	30000	120000	7" reel

# 2N7002DW

## ■ Electrical Characteristics (T<sub>J</sub>=25°C unless otherwise noted)

Parameter	Symbol	Conditions	Min	Typ	Max	Units
<b>Static Parameter</b>						
Drain-Source Breakdown Voltage	BV <sub>DSS</sub>	V <sub>GS</sub> = 0V, I <sub>D</sub> =250μA	60			V
Zero Gate Voltage Drain Current	I <sub>DSS</sub>	V <sub>DS</sub> =60V, V <sub>GS</sub> =0V			1	μA
Gate-Body Leakage Current	I <sub>GSS1</sub>	V <sub>GS</sub> = ±30V, V <sub>DS</sub> =0V			±100	nA
	I <sub>GSS2</sub>	V <sub>GS</sub> = ±20V, V <sub>DS</sub> =0V			±50	nA
Gate Threshold Voltage	V <sub>GS(th)</sub>	V <sub>DS</sub> = V <sub>GS</sub> , I <sub>D</sub> =250μA	1	1.6	2.5	V
Static Drain-Source On-Resistance	R <sub>DS(on)</sub>	V <sub>GS</sub> = 10V, I <sub>D</sub> =300mA		1.2	2.5	Ω
		V <sub>GS</sub> = 4.5V, I <sub>D</sub> =200mA		1.3	3.0	
Diode Forward Voltage	V <sub>SD</sub>	I <sub>S</sub> =300mA, V <sub>GS</sub> =0V			1.2	V
Maximum Body-Diode Continuous Current	I <sub>S</sub>				340	mA
<b>Dynamic Parameters</b>						
Input Capacitance	C <sub>iss</sub>	V <sub>DS</sub> =30V, V <sub>GS</sub> =0V, f=1MHZ		15		pF
Output Capacitance	C <sub>oss</sub>			9.5		
Reverse Transfer Capacitance	C <sub>rss</sub>			5.5		
<b>Switching Parameters</b>						
Total Gate Charge	Q <sub>g</sub>	V <sub>GS</sub> =15V, V <sub>DS</sub> =30V, I <sub>D</sub> =0.3A		1.7	2.4	nC
Turn-on Delay Time	t <sub>D(on)</sub>	V <sub>GS</sub> =10V, V <sub>DD</sub> =30V, I <sub>D</sub> =300mA, R <sub>GEN</sub> =6Ω		5		ns
Turn-off Delay Time	t <sub>D(off)</sub>			17		
Reverse recovery Time	t <sub>rr</sub>	V <sub>GS</sub> =0V, I <sub>S</sub> =300mA, V <sub>R</sub> =25V, di <sub>S</sub> /dt=- 100A/μs		30		ns

A. Pulse Test: Pulse Width ≤300us, Duty cycle ≤2%.

B. Device mounted on FR-4 PCB, 1 inch x 0.85 inch x 0.062 inch.

## ■ Typical Performance Characteristics

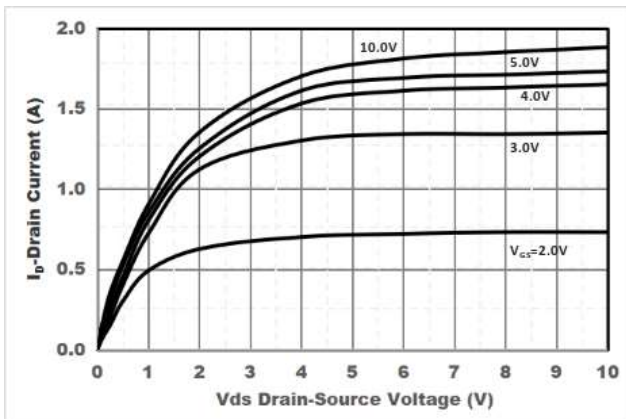

Figure1. Output Characteristics

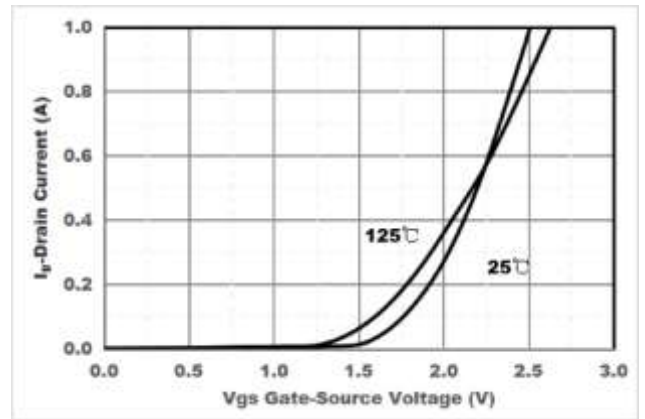

Figure2. Transfer Characteristics

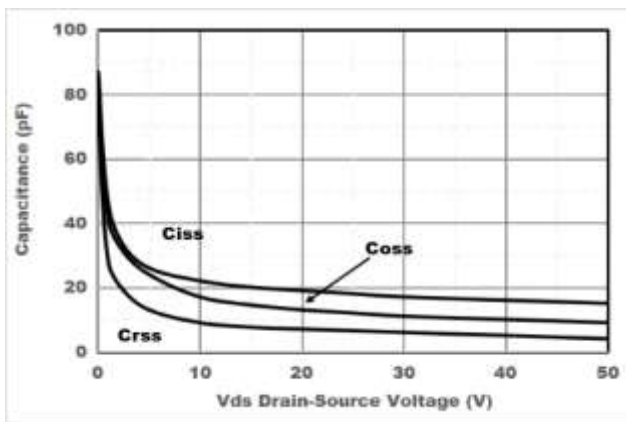

Figure3. Capacitance Characteristics

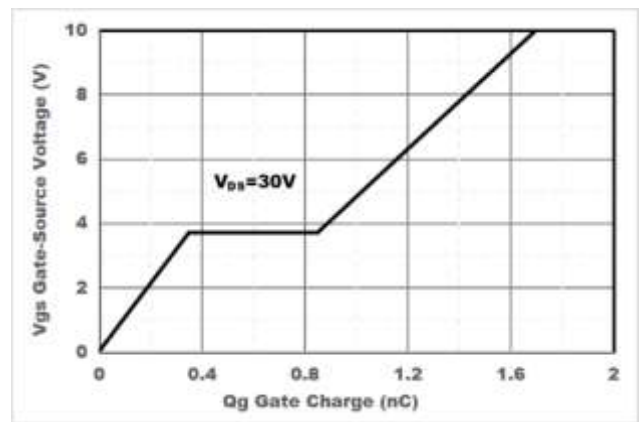

Figure4. Gate Charge

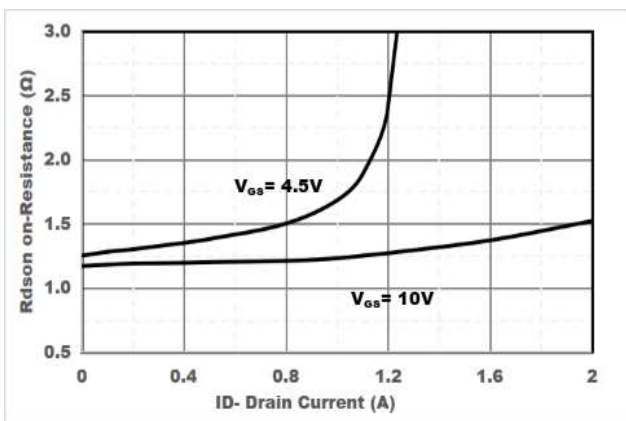

Figure5. Drain-Source on Resistance

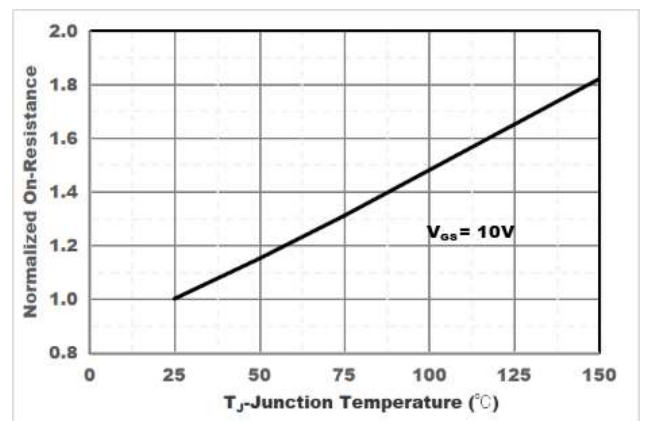

Figure6. Drain-Source on Resistance

# 2N7002DW

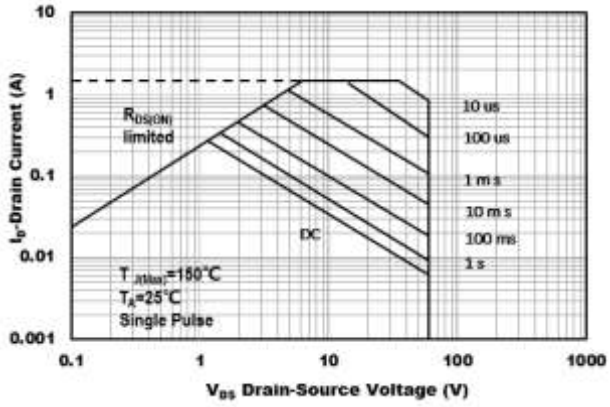

Figure7. Safe Operation Area

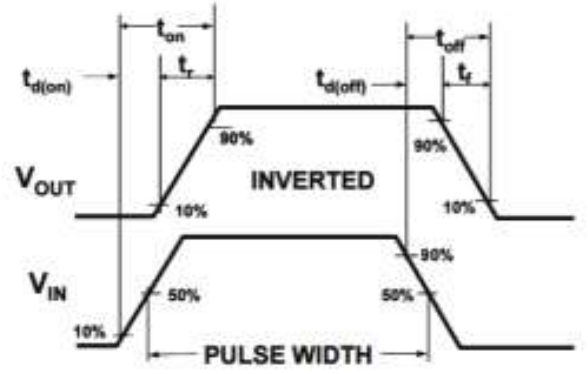
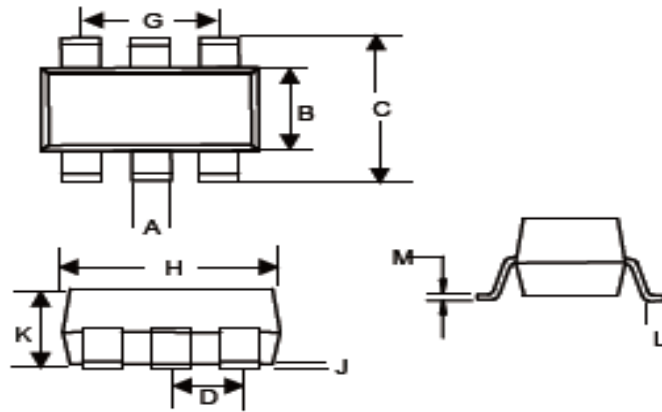

Figure8. Switching wave

# 2N7002DW

## ■ SOT-363 Package information



DIMENSIONS					
DIM	INCHES		MM		NOTE
	MIN	MAX	MIN	MAX	
A	0.006	0.014	0.15	0.35	
B	0.045	0.053	1.15	1.35	
C	0.079	0.096	2.00	2.45	
D	0.026		0.65		TYP.
G	0.047	0.055	1.20	1.40	
H	0.071	0.087	1.80	2.20	
J	----	0.004	----	0.10	
K	0.031	0.043	0.80	1.10	
L	0.010	0.018	0.26	0.46	
M	0.003	0.006	0.08	0.15	

### SUGGESTED SOLDER PAD LAYOUT

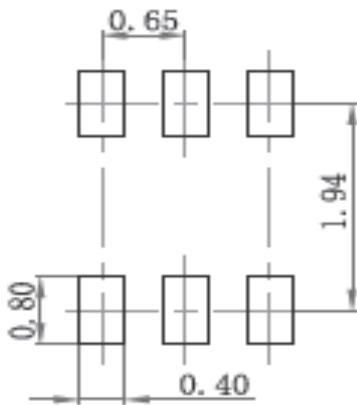

# 2N7002DW

---

## Disclaimer

The information presented in this document is for reference only. Yangzhou Yangjie Electronic Technology Co., Ltd. reserves the right to make changes without notice for the specification of the products displayed herein to improve reliability, function or design or otherwise.

The product listed herein is designed to be used with ordinary electronic equipment or devices, and not designed to be used with equipment or devices which require high level of reliability and the malfunction of which would directly endanger human life (such as medical instruments, transportation equipment, aerospace machinery, nuclear-reactor controllers, fuel controllers and other safety devices), Yangjie or anyone on its behalf, assumes no responsibility or liability for any damages resulting from such improper use of sale.

This publication supersedes & replaces all information previously supplied. For additional information, please visit our website [http:// www.21yangjie.com](http://www.21yangjie.com) , or consult your nearest Yangjie's sales office for further assistance.

## X-ON Electronics

Largest Supplier of Electrical and Electronic Components

*Click to view similar products for [MOSFET](#) category:*

*Click to view products by [Yangjie](#) manufacturer:*

Other Similar products are found below :

[614233C](#) [648584F](#) [MCH3443-TL-E](#) [MCH6422-TL-E](#) [FDPF9N50NZ](#) [FW216A-TL-2W](#) [FW231A-TL-E](#) [APT5010JVR](#) [NTNS3A92PZT5G](#)  
[IRF100S201](#) [JANTX2N5237](#) [2SK2464-TL-E](#) [2SK3818-DL-E](#) [FCA20N60\\_F109](#) [FDZ595PZ](#) [STD6600NT4G](#) [FSS804-TL-E](#) [2SJ277-DL-E](#)  
[2SK1691-DL-E](#) [2SK2545\(Q,T\)](#) [D2294UK](#) [405094E](#) [423220D](#) [MCH6646-TL-E](#) [TPCC8103,L1Q\(CM](#) [367-8430-0972-503](#) [VN1206L](#)  
[424134F](#) [026935X](#) [051075F](#) [SBVS138LT1G](#) [614234A](#) [715780A](#) [NTNS3166NZT5G](#) [751625C](#) [873612G](#) [IRF7380TRHR](#)  
[IPS70R2K0CEAKMA1](#) [RJK60S3DPP-E0#T2](#) [RJK60S5DPK-M0#T0](#) [APT5010JVFR](#) [APT12031JFLL](#) [APT12040JVR](#) [DMN3404LQ-7](#)  
[NTE6400](#) [JANTX2N6796U](#) [JANTX2N6784U](#) [JANTXV2N5416U4](#) [SQM110N05-06L-GE3](#) [SIHF35N60E-GE3](#)