

High Speed Switching Diode

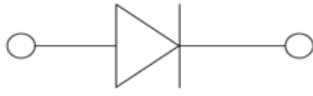

SOD323

Features

- Epoxy meets UL-94 V-0 flammability rating and halogen free
- Moisture Sensitivity Level 1
- V_{RRM} 100V
- I_{FAV} 200mA
- Part no. with suffix "Q" means AEC-Q101 qualified

Applications

- Extreme fast switches

Mechanical Data

- **Case:** SOD323
- **Terminals:** Tin plated leads, solderable per J-STD-002 and JESD22-B102
- **Polarity:** Cathode line denotes the cathode end
- **Marking:** T4

■ Maximum Ratings ($T_a=25^\circ\text{C}$ Unless otherwise specified)

PARAMETER	SYMBOL	UNIT	CONDITIONS	VALUE
Repetitive Peak Reverse Voltage	V_{RRM}	V		100
Average Forward Current	I_{FAV}	mA		200
Peak Forward Surge Current	I_{FSM}	A	$t_p=1\text{ms}$	1
Power Dissipation	P_{tot}	mW		200
Thermal Resistance Junction To Ambient air	R_{thJA}	K/W		635
Maximum Junction Temperature	T_j	$^\circ\text{C}$		150
Storage Temperature Range	T_{stg}	$^\circ\text{C}$		-55 to +150

■ Electrical Characteristics ($T_a=25^\circ\text{C}$ Unless otherwise specified)

PARAMETER	SYMBOL	UNIT	CONDITIONS	MIN	MAX
Forward Voltage	V_F	V	$I_F=1\text{mA}$		0.715
			$I_F=10\text{mA}$		0.855
			$I_F=50\text{mA}$		1.0
			$I_F=150\text{mA}$		1.25
Reverse Current	I_R	μA	$V_R=75\text{V}$		1.0
Reverse Breakdown Voltage	V_{BR}	V	$I_R=100\mu\text{A}$	100	
Diode Capacitance	C_D	pF	$V_R=V_F=0\text{V}$, $f=1\text{MHz}$		4
Reverse Recovery Time	t_{rr}	ns	$I_F=I_R=10\text{mA}$, $I_{rr}=0.1I_R$, $R_L=100\Omega$		6



BAS16WSQ

■ Ordering Information (Example)

PREFERRED P/N	PACKING CODE	UNIT WEIGHT(g)	MINIMUM PACKAGE(pcs)	INNER BOX QUANTITY(pcs)	OUTER CARTON QUANTITY(pcs)	DELIVERY MODE
BAS16WSQ	F2	Approximate 0.0045	3000	30000	120000	7" reel

■ Characteristics (Typical)

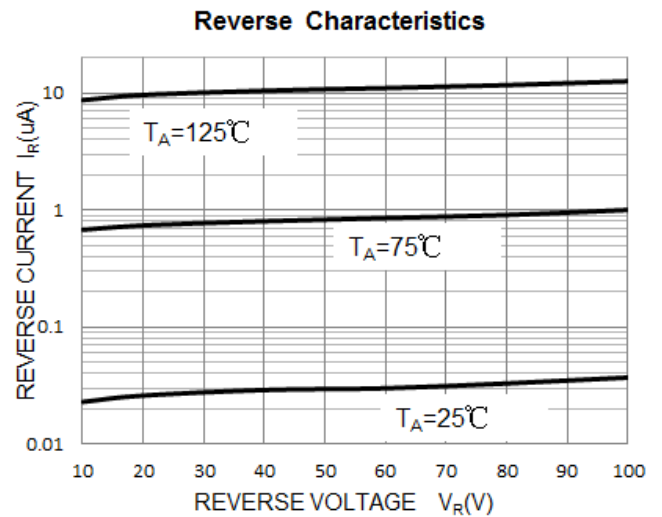
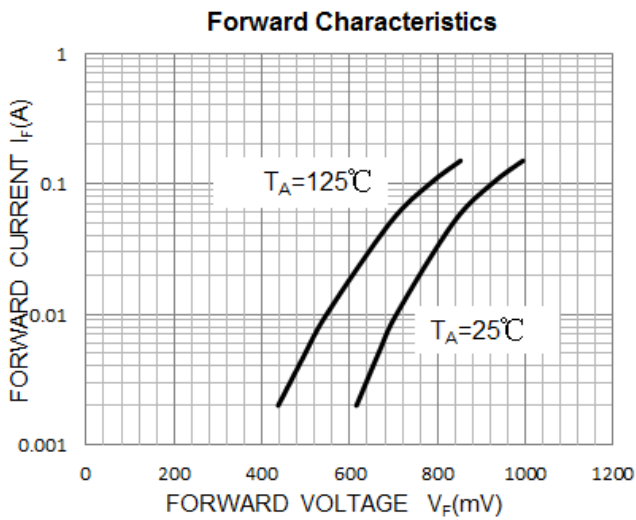
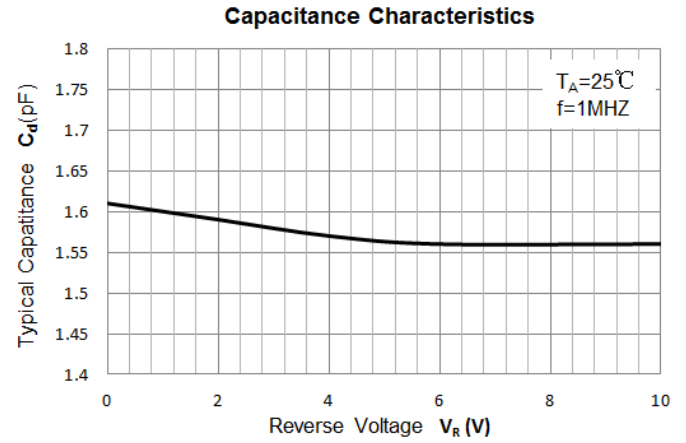
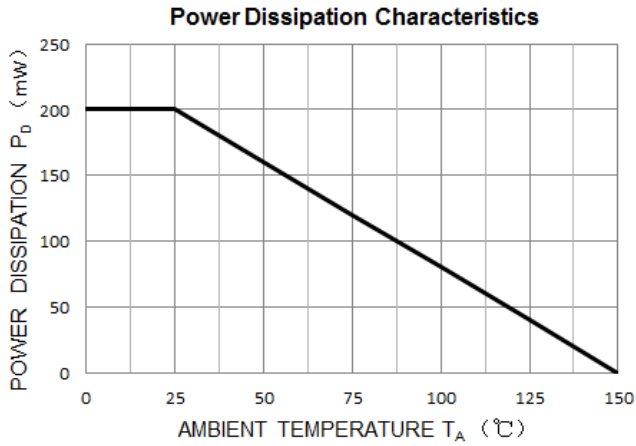



BAS16WSQ

■ Outline Dimensions

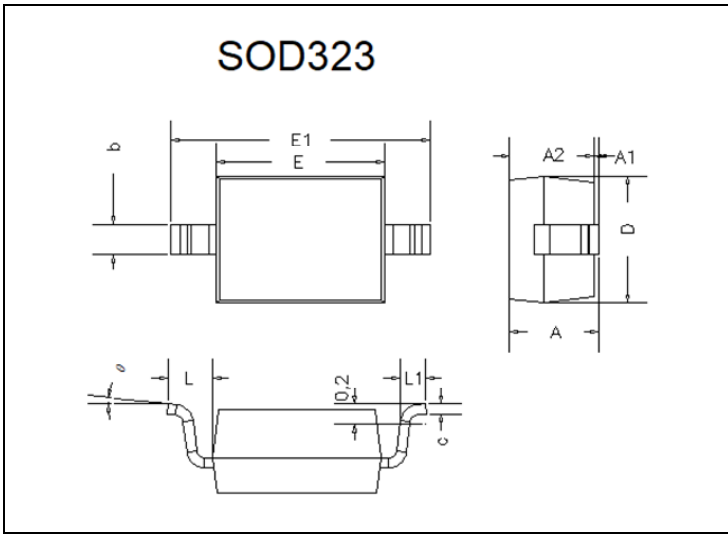

DIM	INCHES		MM		NOTE
	MIN	MAX	MIN	MAX	
A	-	0.039	-	1.00	
A1	0.000	0.004	0.00	0.10	
A2	0.031	0.035	0.80	0.90	
b	0.010	0.016	0.25	0.40	
c	0.003	0.007	0.08	0.17	
D	0.047	0.055	1.20	1.40	
E	0.063	0.071	1.60	1.80	
E1	0.098	0.106	2.50	2.70	
L	0.019REF		0.475REF		
L1	0.008	0.016	0.20	0.40	
θ	0°	8°	0°	8°	

■ Soldering Footprint

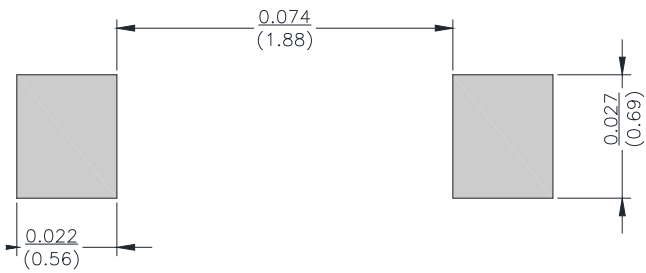

Unit: $\frac{\text{inch}}{\text{mm}}$



BAS16WSQ

Disclaimer

The information presented in this document is for reference only. Yangzhou Yangjie Electronic Technology Co., Ltd. reserves the right to make changes without notice for the specification of the products displayed herein to improve reliability, function or design or otherwise.

The product listed herein is designed to be used with automotive electronics, are not designed for use in medical, life-saving, life-sustaining, or military, Yangjie or anyone on its behalf, assumes no responsibility or liability for any damages resulting from such improper use of sale.

This publication supersedes & replaces all information previously supplied. For additional information, please visit our website [http:// www.21yangjie.com](http://www.21yangjie.com) , or consult your nearest Yangjie's sales office for further assistance.

X-ON Electronics

Largest Supplier of Electrical and Electronic Components

Click to view similar products for [Diodes - General Purpose, Power, Switching category](#):

Click to view products by [Yangjie manufacturer](#):

Other Similar products are found below :

[MCL4151-TR3](#) [MMBD3004S-13-F](#) [RD0306T-H](#) [1N3611](#) [NTE156A](#) [NTE574](#) [NTE6244](#) [1SS193,LF](#) [1SS400CST2RA](#) [SDAA13](#)
[SHN2D02FUTW1T1G](#) [LS4151GS08](#) [1N4449](#) [1N456A](#) [1N4934-E3/73](#) [1N914BTR](#) [RFUH20TB3S](#) [D291S45T](#) [BAV300-TR](#) [BAW56DWQ-](#)
[7-F](#) [BAW56M3T5G](#) [BAW75-TAP](#) [MM230L-CAA](#) [IDW40E65D1](#) [JAN1N3600](#) [JAN1N4454UR-1](#) [LL4151-GS18](#) [SMMSD4148T3G](#)
[BYW95B/A52A](#) [NSVDAN222T1G](#) [CDSZC01100-HF](#) [LL4150-M-08](#) [1N4454-TR](#) [BAV70HDW-7](#) [BAS28-7](#) [JANTX1N6640](#) [BAW56HDW-](#)
[13](#) [BAS28 TR](#) [VS-HFA04SD60STR-M3](#) [NSVM1MA152WKT1G](#) [1SS388-TP](#) [RGP30D-E3/73](#) [VS-8EWF02S-M3](#) [BAV99TQ-13-F](#)
[BAV99HDW-13](#) [MMDB30-E28X](#) [IDP20C65D2XKSA1](#) [LS4148](#) [IDV15E65D2](#) [NSVM1MA152WAT1G](#)